



Printer Driver Manual

For printer model:

CL4NX **Plus**

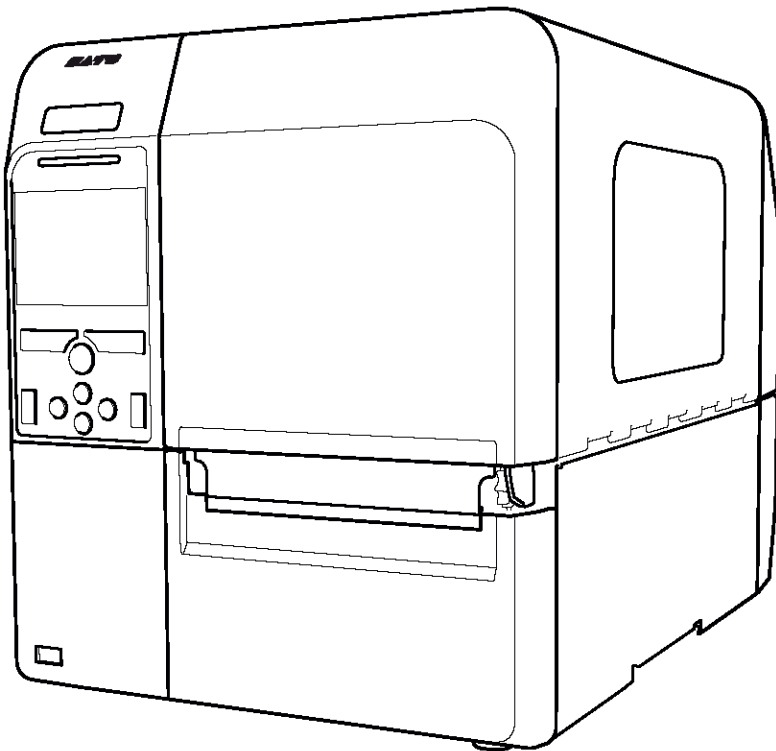

Table of Contents

Before You Start	4
1. Installing the Printer Driver.....	5
1.1 Preparing the Printer Driver.....	7
1.2 Connecting the Product to the Computer.....	8
1.3 Running the Installation.....	11
1.3.1 Installing the Printer Driver When Connected via USB or IEEE1284	11
1.3.2 Installing the Printer Driver When Connected via LAN or Wireless LAN	14
1.3.3 Installing the Printer Driver When Connected via Bluetooth	20
1.3.4 Installing the Printer Driver When Connected via RS-232C.....	28
1.3.5 Installing the Printer Driver for Second and Later Products.....	32
1.3.6 Manually Configuring Settings Necessary to Install the Printer Driver	33
1.3.7 What to Do If the Printer Driver Is Added under [Unspecified].....	39
2. Setting Up the Printer Driver.....	44
2.1 [Printing Defaults] (For All Users) and [Printing Preferences] (For Individual Users).....	44
2.2 How to Get Administrator Privileges	48
3. Settings on the [Driver Settings] Tab.....	49
3.1 Stocks	49
3.1.1 Page Setup.....	50
3.1.2 Print Options.....	51
3.2 Fonts	52
3.2.1 Barcode Font Settings and Usage Example	53
3.2.2 Command Font Settings and Usage Example	58
3.2.3 Substitution Font Settings and Usage Example	63
3.3 Driver Settings	67
3.4 Configure Printer.....	68
3.5 RFID Settings	69
3.6 Maintenance.....	71
3.7 International.....	73
4. Settings on the [Printer Settings] Tab.....	74
4.1 Page Setup.....	75
4.2 Print Options.....	76
4.3 Print Mode	78
4.4 Barcode Verifier	79
4.5 Graphic Options.....	80
4.6 Custom Commands	81
4.7 Maintenance.....	84
4.8 International.....	85

5. Sharing the Product.....	86
5.1 Installing the Printer Driver on the Print Server and Client Computers.....	87
5.2 Configuring Sharing Settings on the Print Server Printer.....	92
5.3 Configuring Sharing Settings on the Client Printer.....	94
6. Updating the Printer Driver	97
7. Uninstalling the Printer Driver	100
8. Removing the Printer Driver Data File	102
9. Checking the Printer Driver Version	104

Before You Start

A printer driver is software that sends data created on a computer (documents and illustrations) to the printer and print it on a label. The CL4NX Plus Printer Driver Manual (hereinafter, "this manual") describes how to obtain and install the printer driver for the CL4NX Plus (hereinafter, "the product"). It also describes how to configure various settings after installing the printer driver, and how to uninstall and update the printer driver.

Printer Driver Screenshots Used in This Manual

This manual mainly uses screenshots of the printer driver for the product captured on Windows 10. Therefore, the screen layout may differ depending on the OS that you are using.

Limitation of Liability

SATO Corporation and its subsidiaries in Japan, the U.S. and other countries make no representations or warranties of any kind regarding this material, including, but not limited to, implied warranties of merchantability and fitness for a particular purpose. SATO Corporation shall not be held responsible for errors contained herein or any omissions from this material or for any damages, whether direct, indirect, incidental or consequential, in connection with the furnishing, distribution, performance or use of this material.

Specifications and contents in this document are subject to change without notice.

Trademarks

- SATO is a registered trademark of Sato Holdings Corporation and its subsidiaries in Japan, the U.S. and other countries.
- Wi-Fi® is a registered trademark of Wi-Fi Alliance.
- Windows is a registered trademark of Microsoft Corporation in the United States and/or other countries.
- Bluetooth is a trademark of Bluetooth SIG, Inc., U.S.A.
- All other trademarks are the property of their respective owners.

Copyrights / Other Matters

Any unauthorized reproduction of the contents of this document, in part or whole, is strictly prohibited.

First Edition October 2019

© 2019 SATO Corporation. All rights reserved.

1. Installing the Printer Driver

By installing a printer driver on a computer, data created with the computer can be printed by the product. You must first connect the product to a computer and then install the printer driver. The installation method varies depending on how the computer and product are connected.

Printer Driver Operating Environment

- A computer screen resolution of at least 1024 x 768 pixels is recommended. If it is lower than that, part of the screen will not be shown.
- The printer driver supports the following OSs:
Windows 10, Windows 8.1, Windows 7,
Windows Server 2019, Windows Server 2016, Windows Server 2012,
Windows Server 2012 R2 (64-bit only), Windows Server 2008 R2 (64-bit only),
and Windows Server 2008.

Supported Connection Methods

The printer driver can be installed when the product is connected to a computer in one of the following ways:

- USB
- LAN/Wireless LAN (when the optional wireless LAN kit is installed)
- Bluetooth
- RS-232C
- IEEE1284

Process to Install the Printer Driver

The process to install the printer driver is as follows:

1. Prepare the printer driver installer on a computer.
An installer is used to install the printer driver.
For details, refer to "1.1 Preparing the Printer Driver."
2. Connect the product to the computer using one of the interface connections.
For details, refer to "1.2 Connecting the Product to the Computer."
3. Install the printer driver on the computer.
 - When the product is connected via USB or IEEE1284, refer to "1.3.1 Installing the Printer Driver When Connected via USB or IEEE1284."
 - When the product is connected via LAN or wireless LAN, refer to "1.3.2 Installing the Printer Driver When Connected via LAN or Wireless LAN."
 - When the product is connected via Bluetooth, refer to "1.3.3 Installing the Printer Driver When Connected via Bluetooth."
 - When the product is connected via RS-232C, refer to "1.3.4 Installing the Printer Driver When Connected via RS-232C."
4. Set up the installed printer driver as necessary.
For details, refer to the following sections:
 - "2. Setting Up the Printer Driver"
 - "3. Settings on the [Driver Settings] Tab"
 - "4. Settings on the [Printer Settings] Tab"

Precautions When Installing the Printer Driver

- Before starting the installation, close all applications.
- When you perform the printer driver setup, the properties settings, or the print settings, log in with Administrator Privileges.
- When you use the printer driver, enable bi-directional communication.
- If the terminal service is being started with Windows Server 2008, or the remote desktop service is being started with Windows Server 2008 R2, Windows Server 2012, Windows Server 2012 R2, Windows Server 2016, or Windows Server 2019, change the terminal service or remote desktop service to the installation mode. However, it is not guaranteed that the printer driver can be used in the terminal service or remote desktop service environment.
- When using multiple products, it is necessary to install as many printer drivers as products, to identify each product.

1.1 Preparing the Printer Driver

Download the printer driver from the SATO download site onto the computer. A compressed file will be downloaded. Extract it to anywhere on the computer.

Downloading the Printer Driver

1. Start the computer and open your web browser.
2. Go to the SATO download site (www.satoworldwide.com/software/gallerydriver.aspx).
3. Download the printer driver.
A compressed file will be downloaded.

Extracting the Compressed Files

4. Extract the compressed files.
"PrnInst.exe" is the installer.

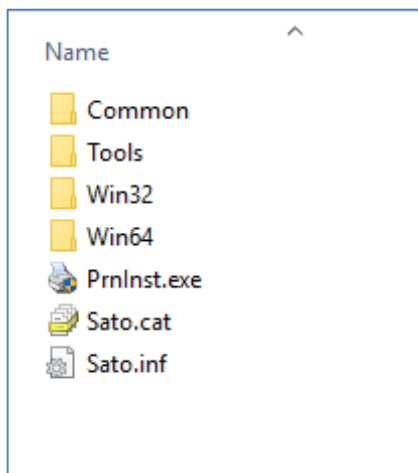

The file "PrnInst.exe" is used not only to install the printer driver but also to update and uninstall the printer driver.

1.2 Connecting the Product to the Computer

Before installing the printer driver, connect the product to the computer.

Caution

Power off the product before connecting to the computer.

Connecting via USB Cable

One end of the cable to connect the product must be Type B and the other end Type A with a length of less than 5 meters.

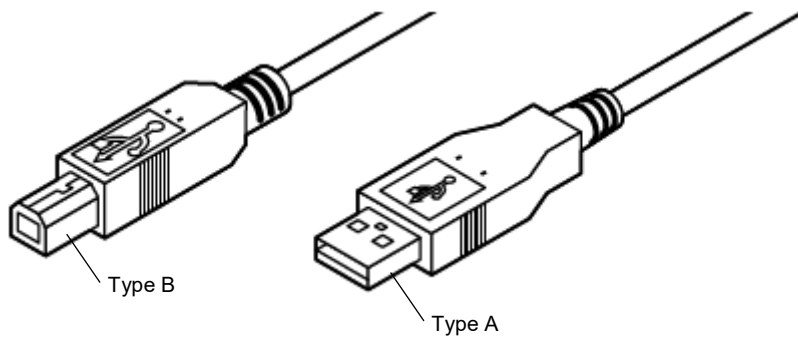

1. Power off the product.
2. Connect the USB cable to the product.

Connect the USB cable (Type B) to the connector shown in the figure.

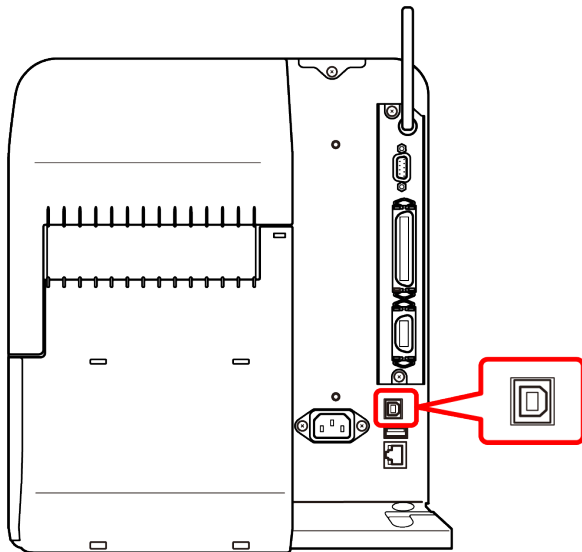

3. Connect the USB cable to the computer.

Connecting via LAN Cable

1. Power off the product.
2. Connect the LAN cable to the product.
Connect the LAN cable to the connector shown in the figure.

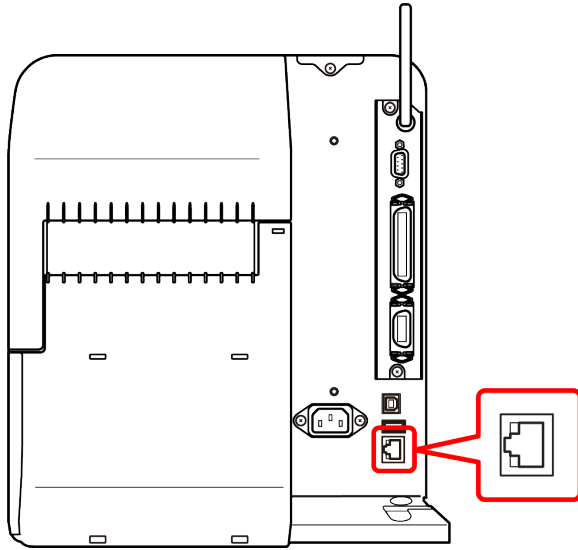

3. Connect the LAN cable according to your network environment.
4. Configure the network settings.
For details on the network settings, refer to "CL4NX Plus Operator Manual."

Connecting via Wireless LAN (When the Optional Wireless LAN Kit Is Installed)

Check whether the wireless LAN kit is installed to the product.

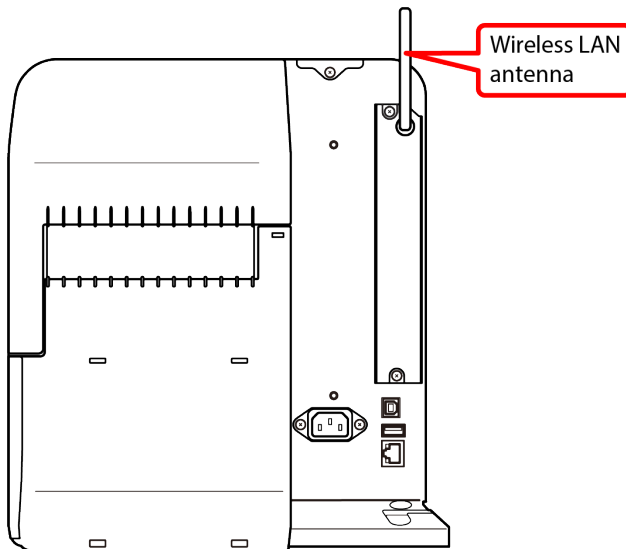

For details on the wireless LAN network settings, refer to "CL4NX Plus Operator Manual."

Connecting via RS-232C Cable

1. Power off the product.
2. Connect the RS-232C cable to the product.
Connect the RS-232C cable to the connector shown in the figure.

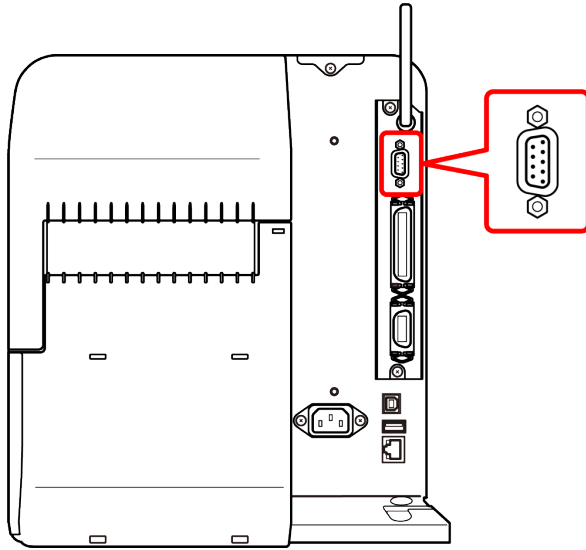

3. Connect the RS-232C cable to the computer.

Connecting via IEEE1284 Cable

1. Power off the product.
2. Connect the IEEE1284 cable to the product.
Connect the IEEE1284 cable to the connector shown in the figure.

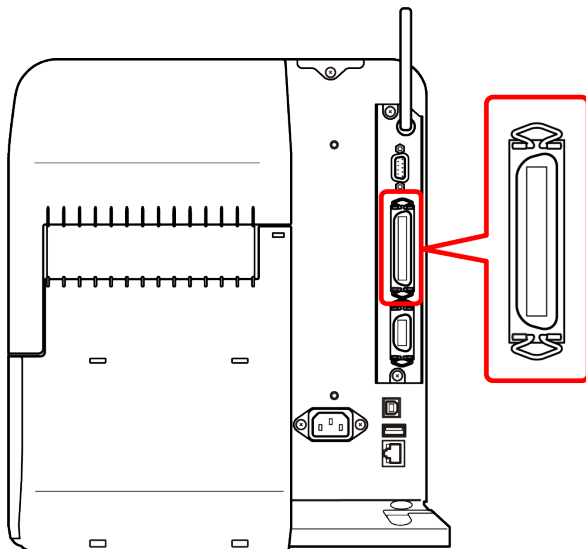

3. Connect the IEEE1284 cable to the computer.

1.3 Running the Installation

The printer driver installation procedure differs depending on how the computer and product are connected.

Check how the product is connected before running the installation.

The printer driver installer is the same as other models. Ports that are not supported by the product may be shown. Read this manual carefully and check the port to be used.

1.3.1 Installing the Printer Driver When Connected via USB or IEEE1284

This section describes how the printer driver is installed automatically with the Plug and Play feature.

Note:

- Automatic printer detection is supported only on a USB port and IEEE1284 port.
 - Before starting the installation, close all applications.
 - When you perform the printer driver setup, the properties settings, or the print settings, log in with Administrator Privileges.
 - When you use the printer driver, enable bi-directional communication.
 - If the terminal service is being started with Windows Server 2008, change the terminal service to the installation mode. However, it is not guaranteed that the printer driver can be used in the terminal service environment.
 - When using multiple products, it is necessary to install as many printer drivers as products, to identify each product.
 - After installing the printer driver for the first product, the printer driver for the second and additional products will be automatically installed when the products are connected to the computer and powered on. However, the names of the printer drivers will be "printer driver name (1)", "printer driver name (2)" etc. To change the printer driver name, right-click the printer driver in [Devices and Printers], select [Printer properties], and change the name at the top of the [General] tab.
-

1. Power on the product.
2. Connect the product to a computer, using a USB cable or IEEE1284 cable.
The printer driver is located online and downloaded to the computer. Automatic installation starts immediately.

If the Printer Driver Is Available at the Windows Update Site (Automatic Installation)

On the latest operating systems (Windows 7 and later), a system notification message is shown. If you click the notification message, the new [Driver Software Installation] dialog box opens. Monitor the installation status, using this dialog box. Closing the dialog box finishes the installation.

If the Printer Driver Is Unavailable at the Windows Update Site (Manual Installation)

If the printer driver is unavailable at the Windows Update site, the connected product will be recognized as "Other devices". Download the printer driver to the local disk. Select this product at the SATO download site (www.satoworldwide.com/software/gallerydriver.aspx) and download "Printer Driver".

Follow these steps to install the printer driver using the [Update driver] procedure.

1. Open [Control Panel] and click [Hardware and Sound] > [Devices and Printers] > [Device Manager].

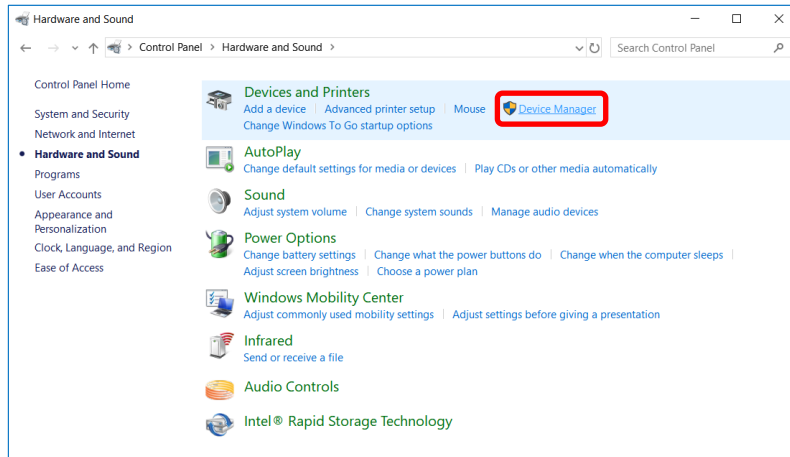

2. Expand the node [Other devices] to show the installed printer driver, then right-click the printer driver and select [Update driver].

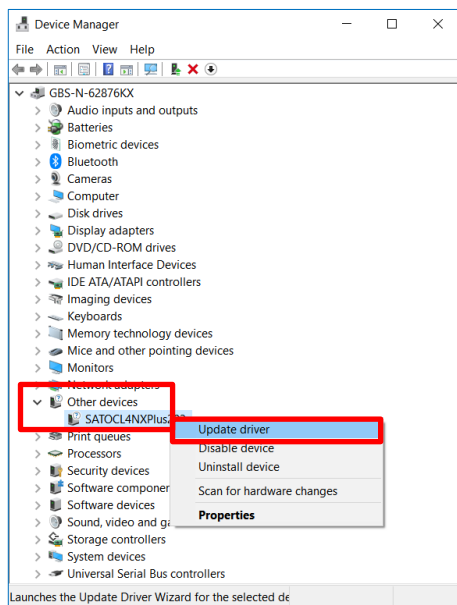

3. At the message [How do you want to search for drivers?], select [Browse my computer for driver software].

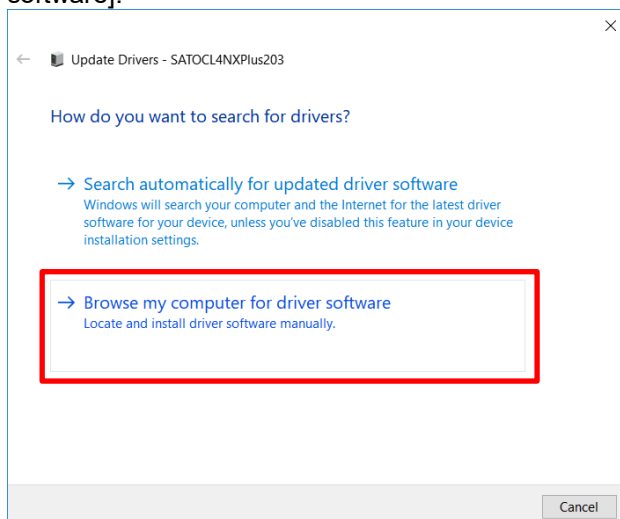

4. Click [Browse] and search for the printer driver folder that you have downloaded.

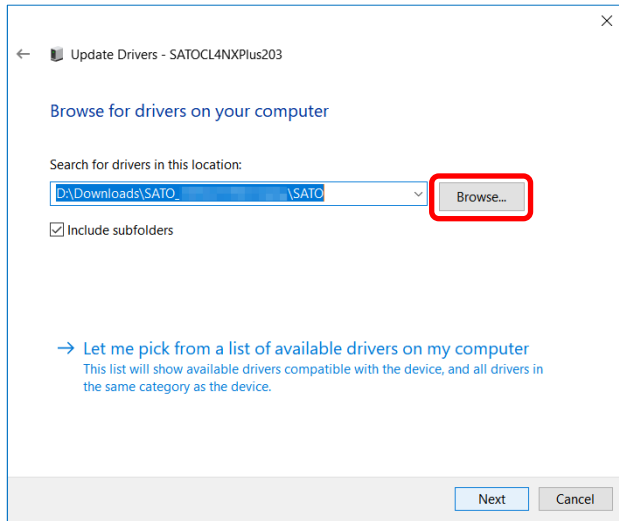

5. Once located, expand the node and select the [SATO] folder then click [OK].

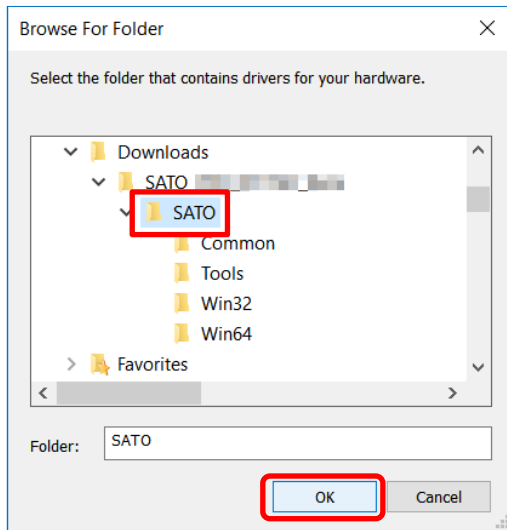

6. Click [Next]. Wait for the printer driver to be updated or installed accordingly.

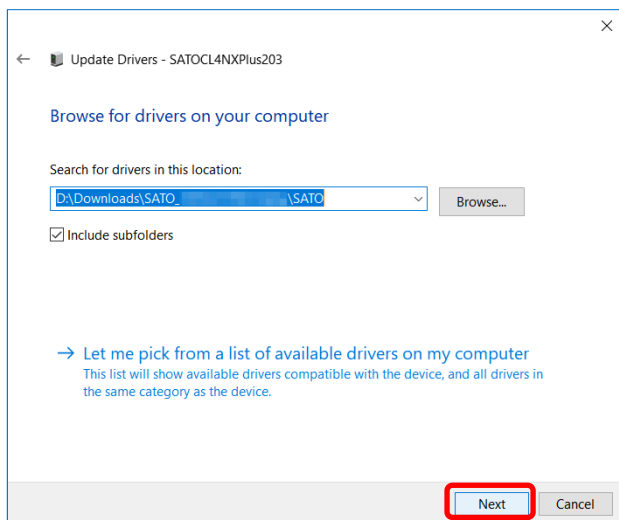

1.3.2 Installing the Printer Driver When Connected via LAN or Wireless LAN

1. Power on the product and confirm that it is connected to the network.
2. Double-click PmInst.exe.
The printer installation wizard starts.
3. Click [Next].

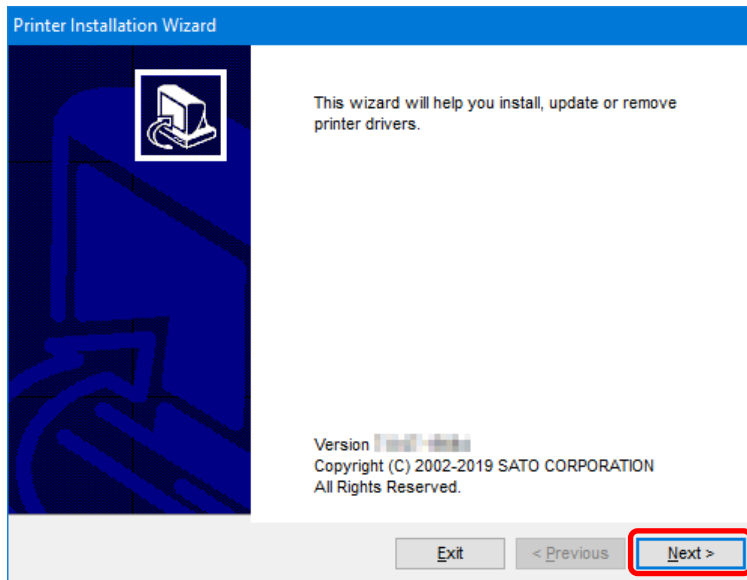

4. Click [Install Printer Driver].

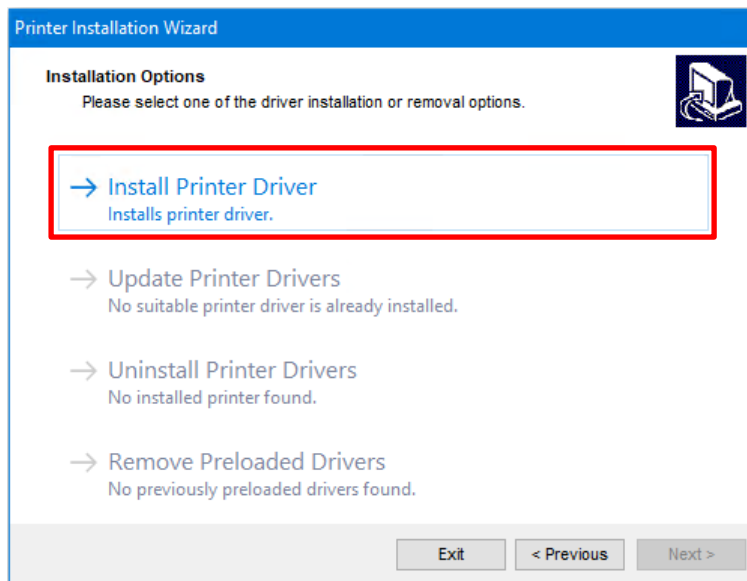

5. Click [Network Port].

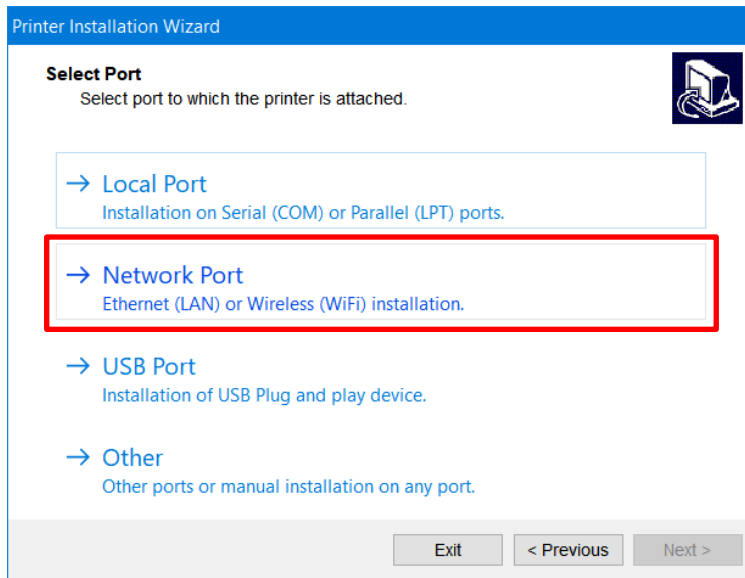

6. Select the product to add and click [Add].

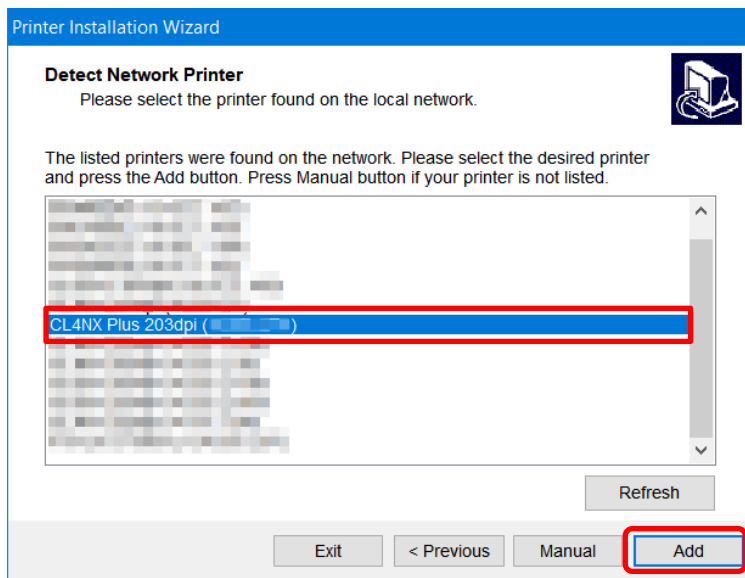

If the product is not shown, check that the product is powered on and connected to the network, and click [Refresh].

If the product is still not shown, add the product using the following procedure.

- a. Click [Manual].

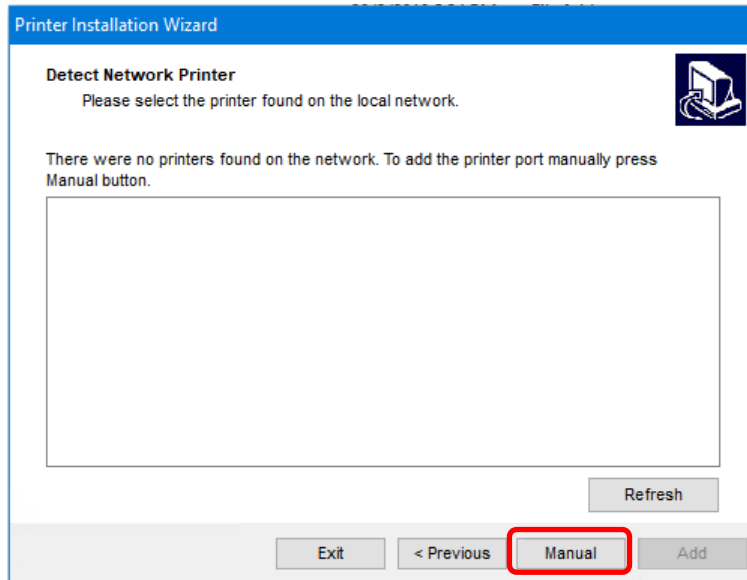

- b. Select the model of the product and click [Next].
The following illustration shows SATO CL4NX PLUS 203dpi is selected as an example.

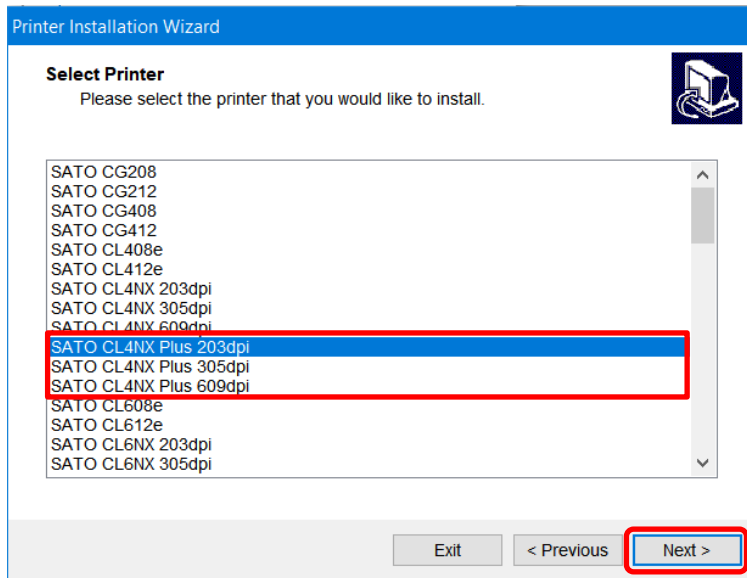

Note:

Select the model that is compatible with the resolution of the product. The resolution of the product is shown on the upper left of the Online/Offline screen.



- c. Select [Create a new network port] and click [Next].

When a network port already exists, select [Use an existing port] to use the port. Select the port from the list, click [Next] and proceed to step 7.

Printer Installation Wizard
Select the port your printer is connected to.

Create a new network port
 Use an existing port:

Port	Type	Configuration
LPT1:	Printer Port	
LPT2:	Printer Port	
LPT3:	Printer Port	
COM1:	Serial Port	
COM2:	Serial Port	
COM3:	Serial Port	
COM4:	Serial Port	
FILE:	Local Port	

Show all ports Configure

Exit < Previous **Next >**

- d. Enter the IP address of the product into [Printer Name or IP Address], and click [Next].
If the same port name exists, change [Port name] and then click [Next].

Printer Installation Wizard
Enter port configuration for the desired printer.

Port name: LAN_SATO_CL6NX_Plus_203dpi

Printer Name or IP Address:

Port number: 9100

Exit < Previous **Next >**

7. Click [Install].

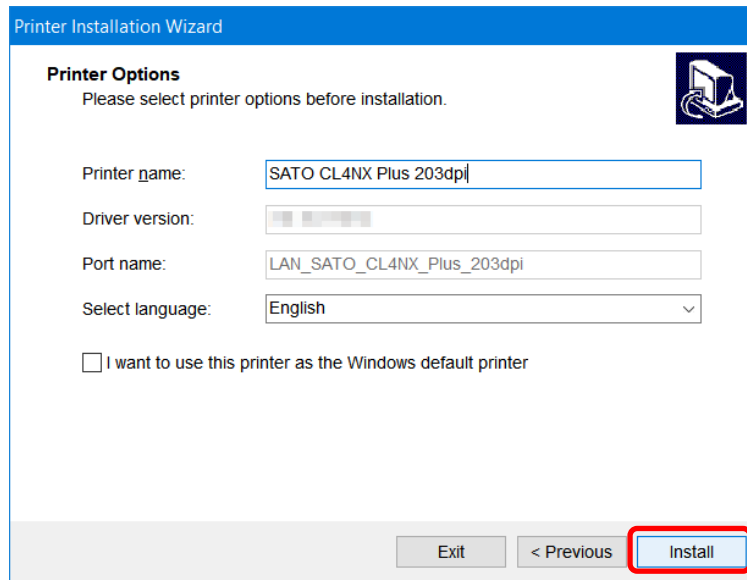

When the [Windows Security] screen appears, click [Install].

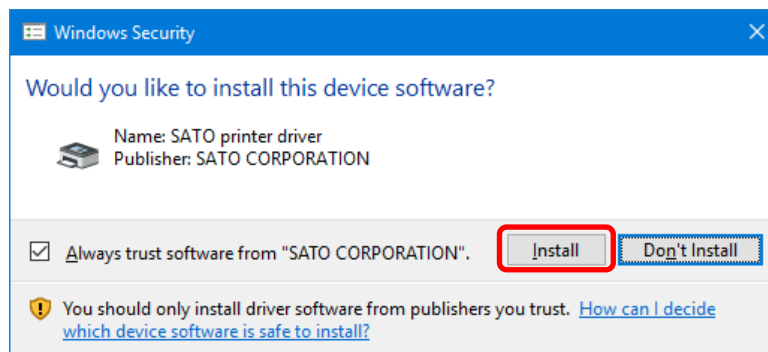

Note:

The warning screen above may not appear, depending on the version of the printer driver or your computer environment.

If a security warning screen indicating that another process is blocking access appears, follow the on-screen instructions.

8. Confirm that [succeeded] is shown for the installed printer driver and click [Exit].

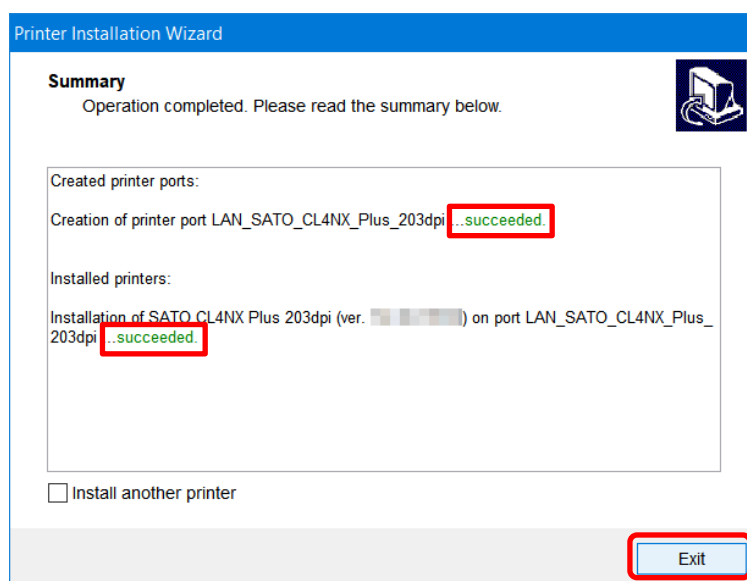

9. Open [Devices and Printers] and confirm that the printer driver has been added to the list of [Printers].

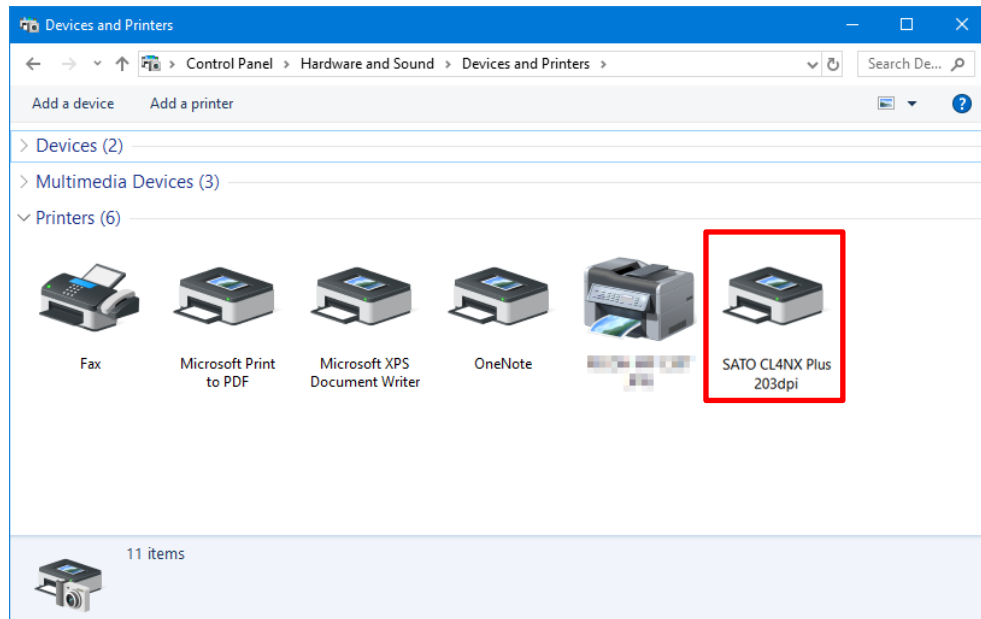

1.3.3 Installing the Printer Driver When Connected via Bluetooth

Add the product to the computer as a Bluetooth device (this is called pairing) and install the printer driver on the computer. The procedure for pairing a Bluetooth device varies depending on your computer environment. The following procedure is an example using Windows 10.

For details, refer to the user manual of your computer.

For details on the product screen and operations, refer to "CL4NX Plus Operator Manual."

Pairing the Product with the Computer

1. Start the computer.
2. Power on the product.
3. Confirm that Bluetooth is enabled (initial value) in the [Interface] menu of the product.

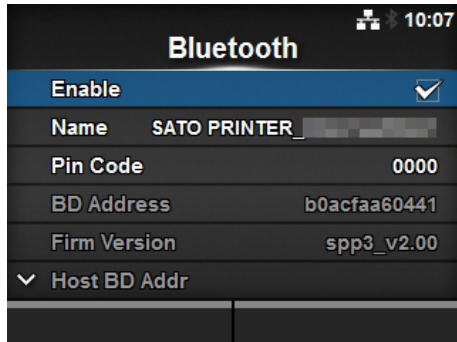

- The [Enable] check box is selected.
- Name (default: SATO PRINTER_XXXXXXXXXX)
"XXXXXXXXXX" is a 12-digit alphanumeric value.

Note:

You can change the name by tapping the "Name".

4. Click the arrow ([Show hidden icons]) ([a]) on the bottom-right of the computer desktop, right-click the Bluetooth icon ([b]), and select [Add a Bluetooth Device].

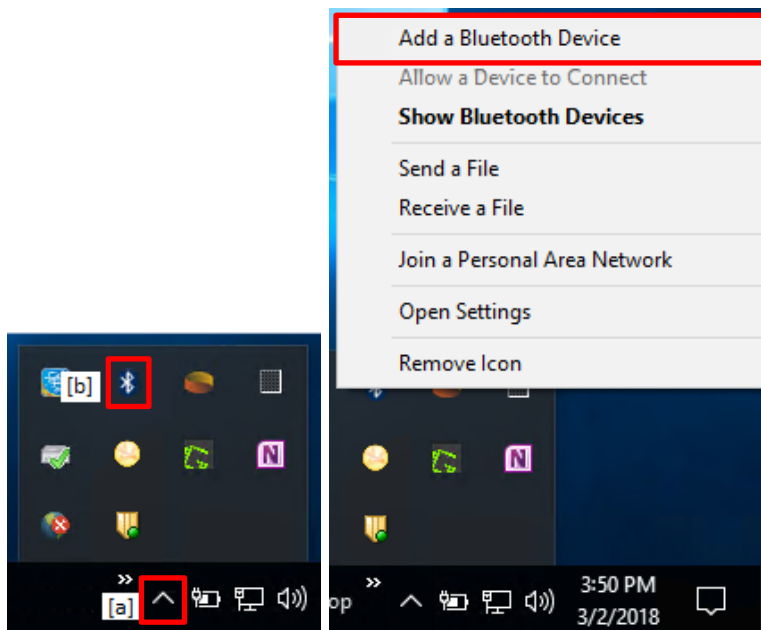

5. Click [Add Bluetooth or other device].

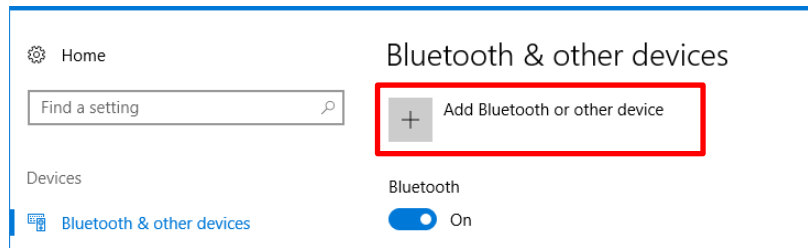

6. Click [Bluetooth].

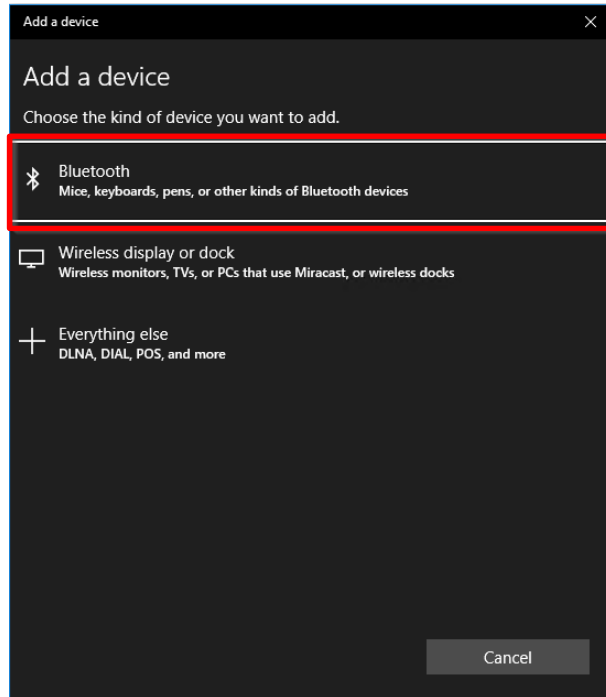

7. On the list of discovered devices, select the name of the device that you confirmed in step 3.
8. Follow the instructions on the computer and product screens.
9. Click [Done].

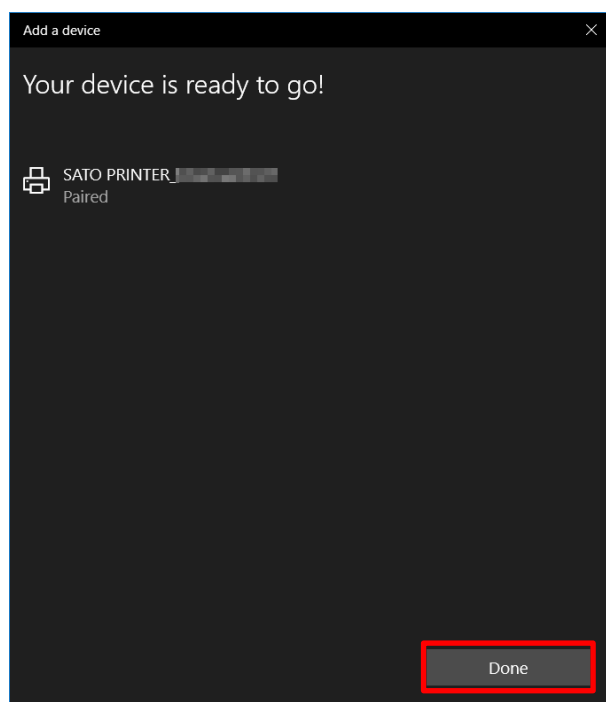

Installing the Printer Driver

1. Open [Devices and Printers], right-click the added printer, and select [Properties].

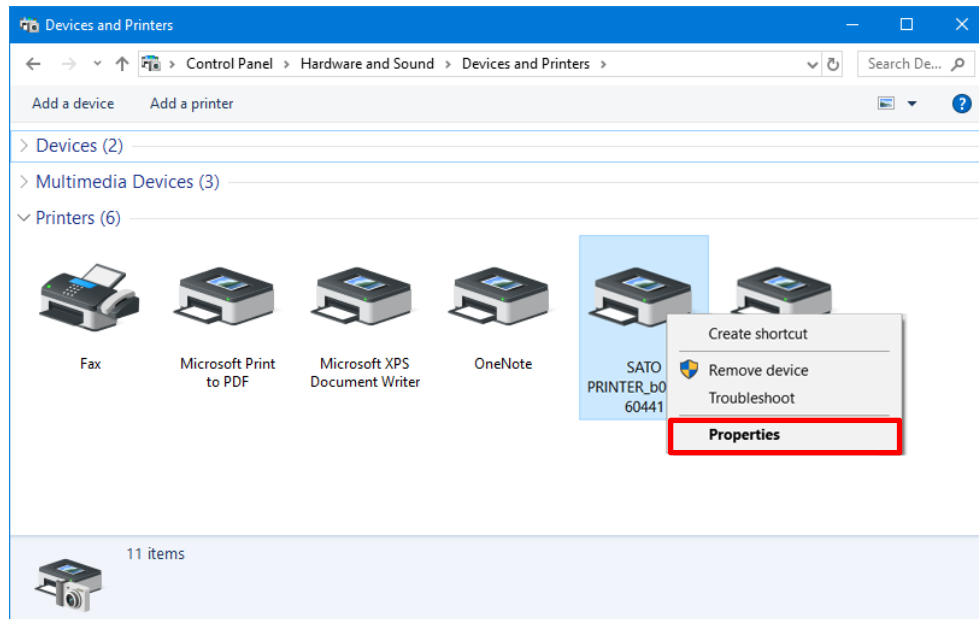

2. Confirm the port assigned to [Serial port (SPP)] on the [Services] tab and click [OK]. This information is necessary when installing the printer driver so be sure to write it down.

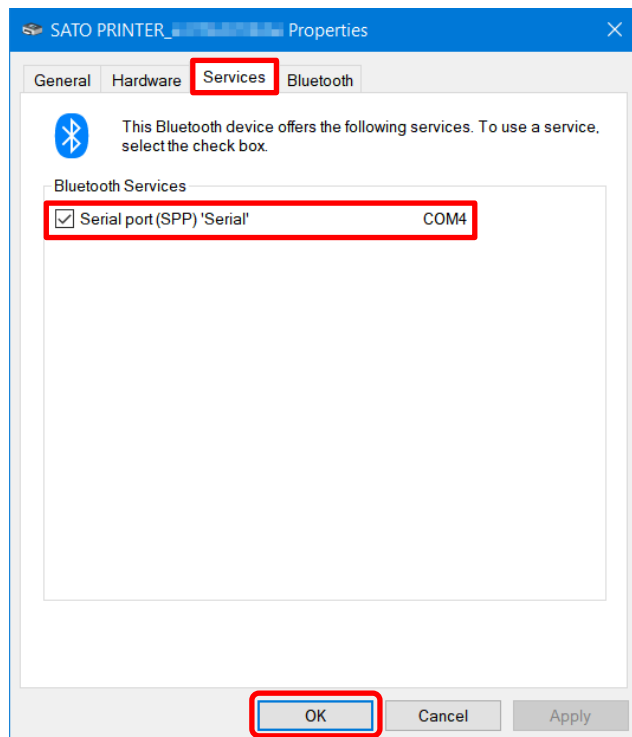

3. Double-click PrnInst.exe.
The printer installation wizard starts.
4. Click [Next].

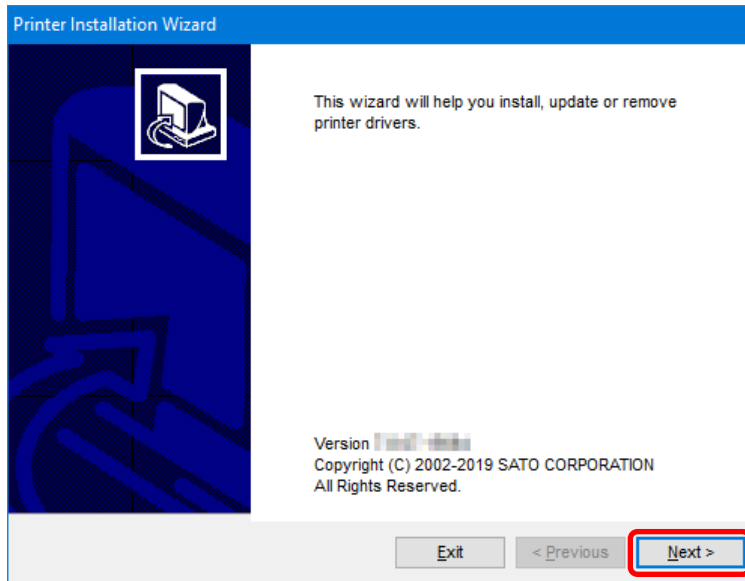

5. Click [Install Printer Driver].

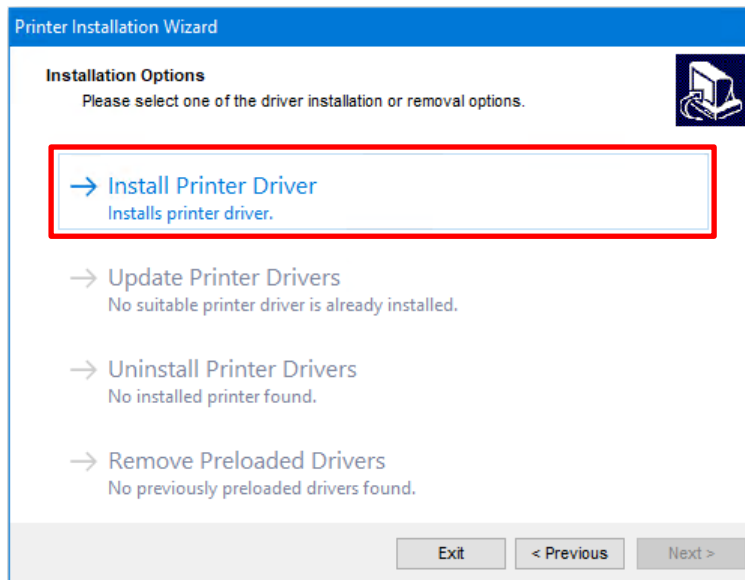

6. Click [Other].

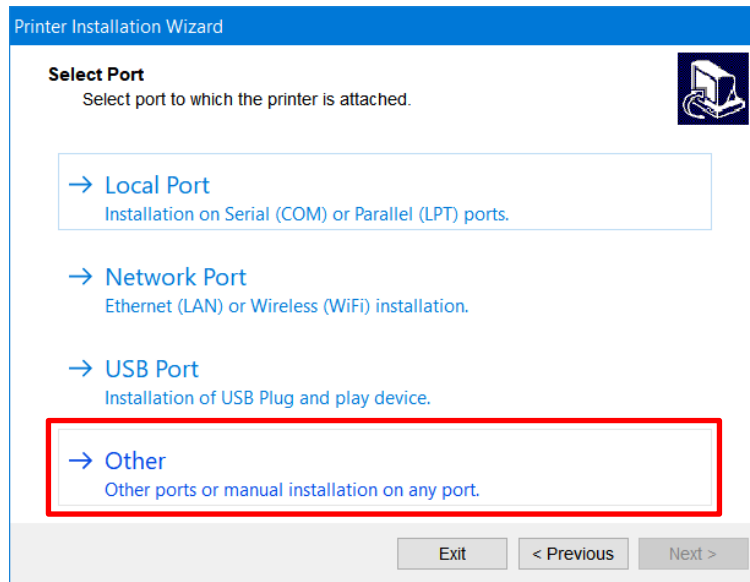

7. Select the model of the product and click [Next].

The following illustration shows SATO CL4NX PLUS 203dpi is selected as an example.

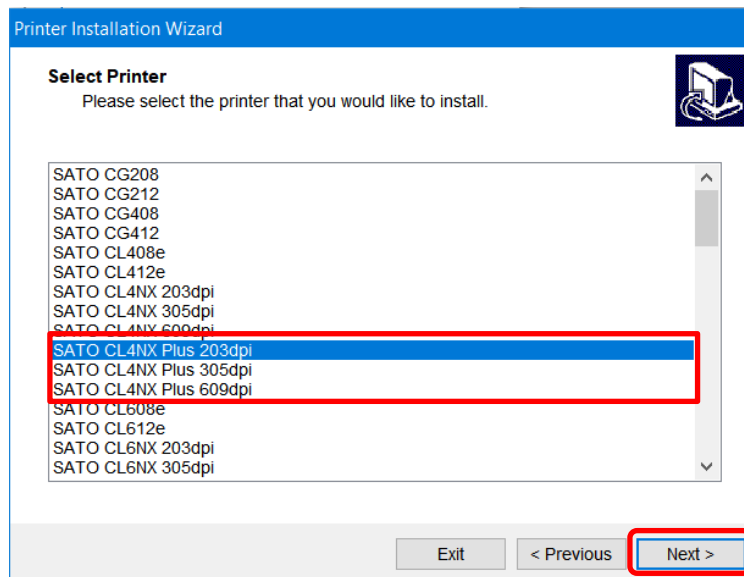

Note:

Select the model that is compatible with the resolution of the product. The resolution of the product is shown on the upper left of the Online/Offline screen.



8. Click [Add Port].

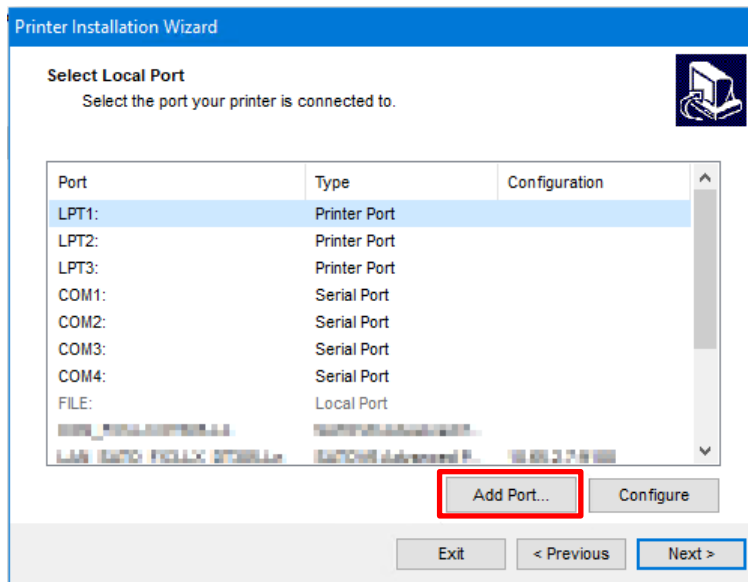

9. Select [SERIAL (COM)] from the [Select port type] drop down list and click [OK].

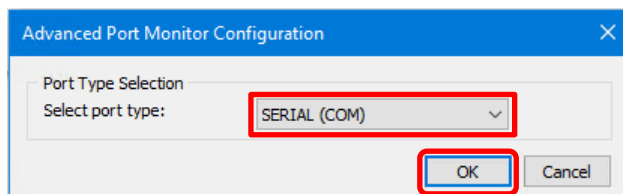

10. Configure the port settings and click [OK].

Configure the following settings:

[Port name]: Enter a name (E.g., CL4NX Plus-BT)

[Serial port]: Select the port you checked in step 2.

[Flow control]: Select [None].

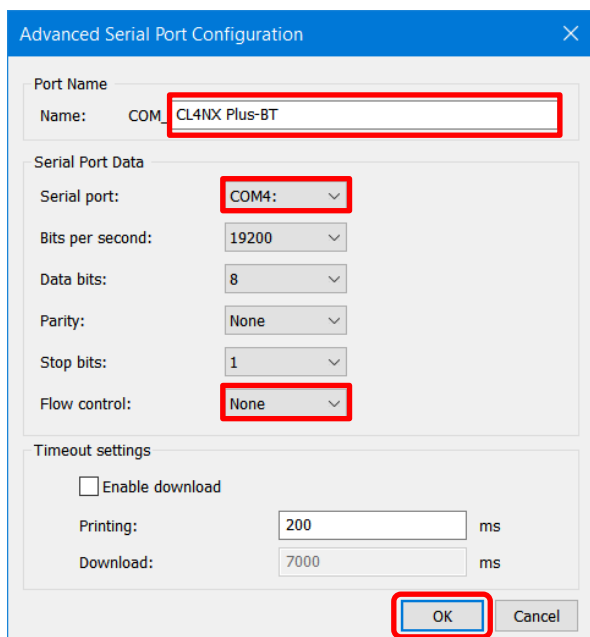

11. Click [Next].

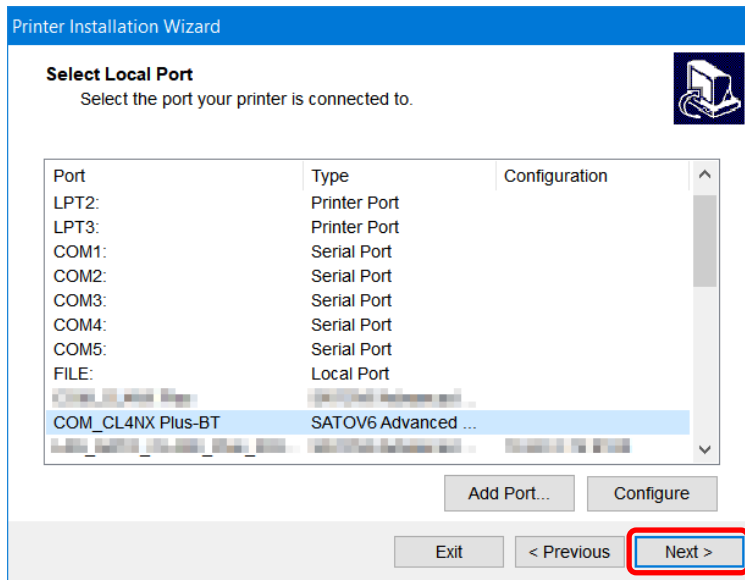

12. Click [Install].

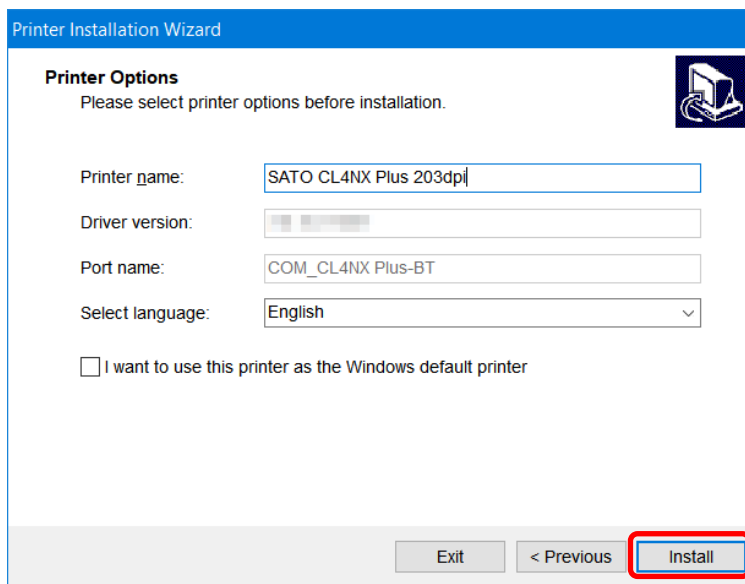

When the [Windows Security] screen appears, click [Install].

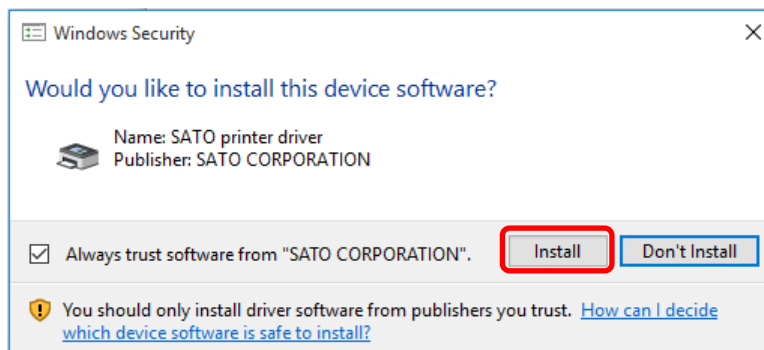

Note:

The warning screen above may not appear, depending on the version of the printer driver or your computer environment.

If a security warning screen indicating that another process is blocking access appears, follow the on-screen instructions.

13. Confirm that [succeeded] is shown for the installed printer driver and click [Exit].

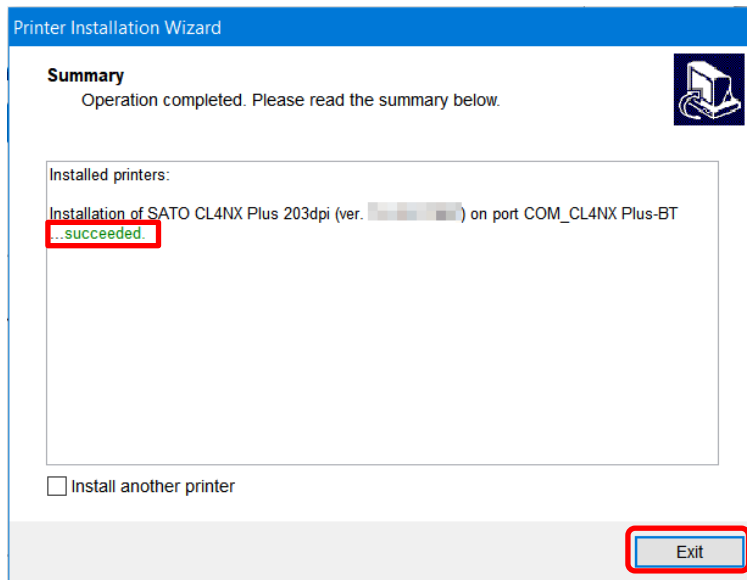

14. Open [Devices and Printers] and confirm that the printer driver has been added to the list of [Printers].

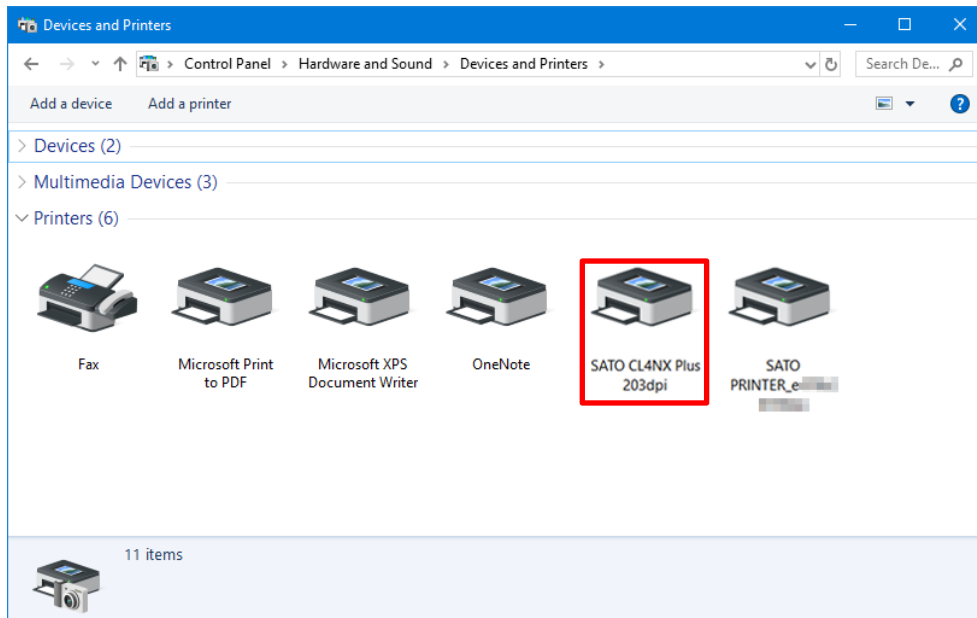

The printer driver can be used with the Bluetooth interface connection.

When printing, use the name of the product added when the printer driver was installed, not the name of the product added as the Bluetooth device.

1.3.4 Installing the Printer Driver When Connected via RS-232C

1. Connect the product and computer with the RS-232C cable, and power on the product.
2. Double-click PmInst.exe.
The printer installation wizard starts.
3. Click [Next].

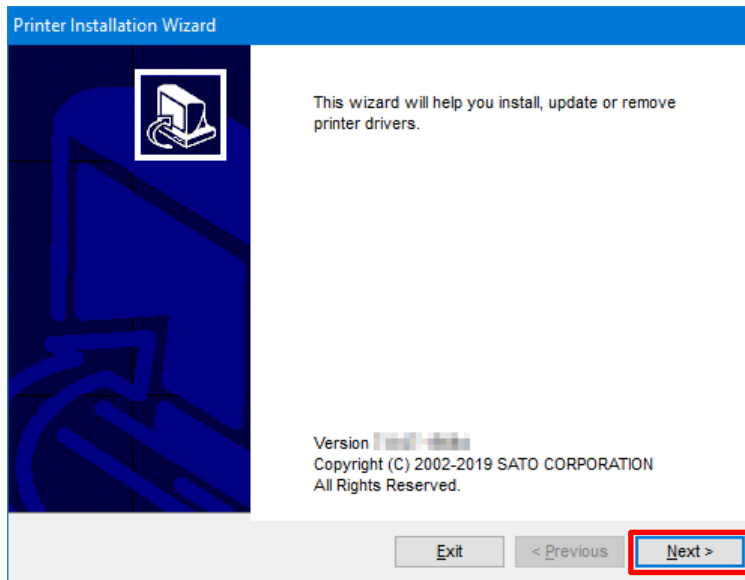

4. Click [Install Printer Driver].

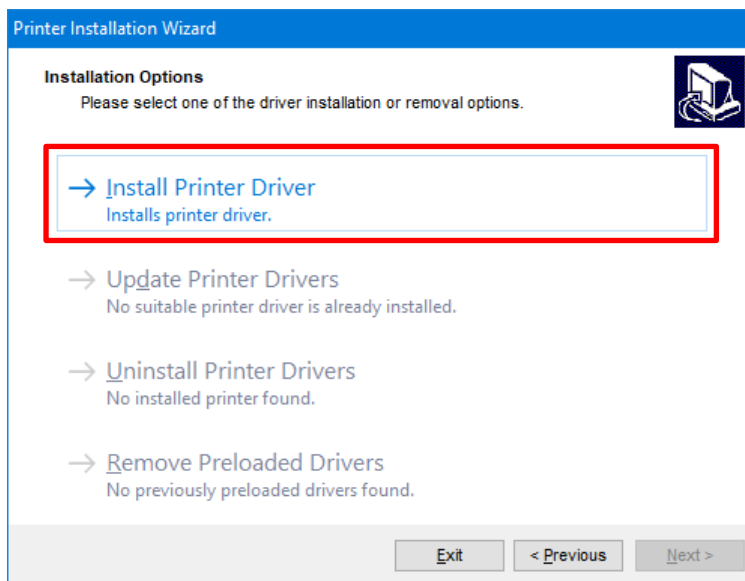

5. Click [Local Port].

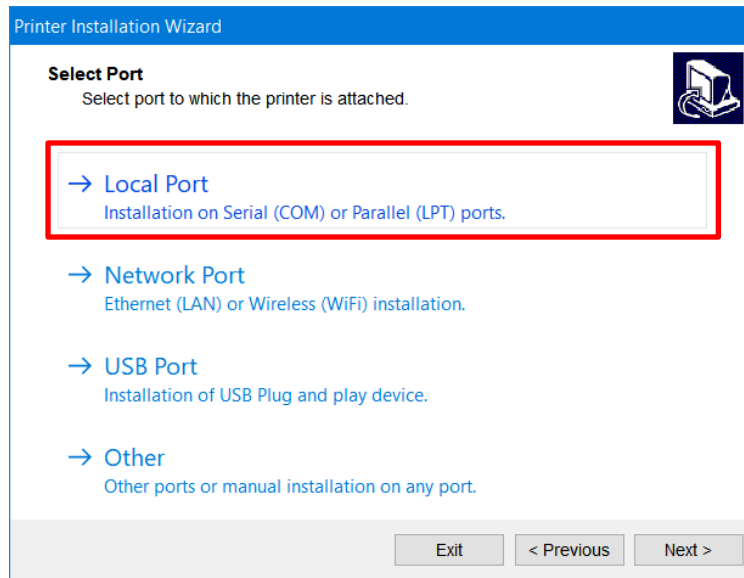

6. Select the model of the product and click [Next].
The following illustration shows SATO CL4NX PLUS 203dpi is selected as an example.

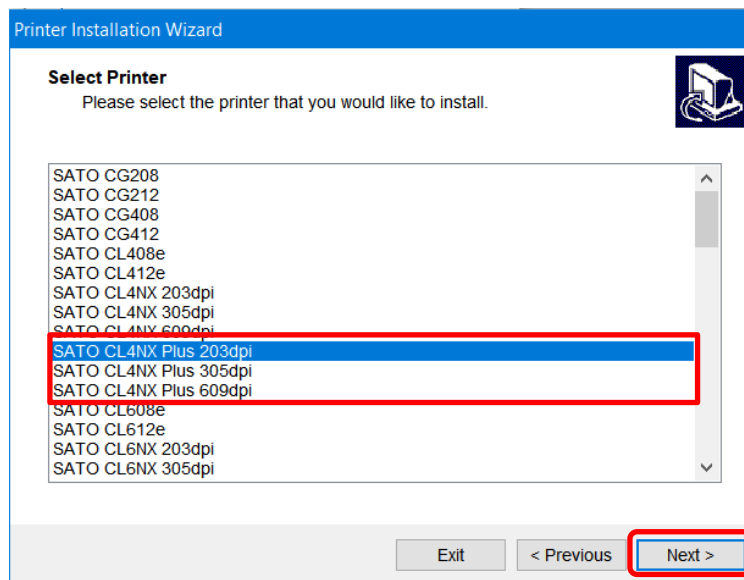

Note:

Select the model that is compatible with the resolution of the product. The resolution of the product is shown on the upper left of the Online/Offline screen.

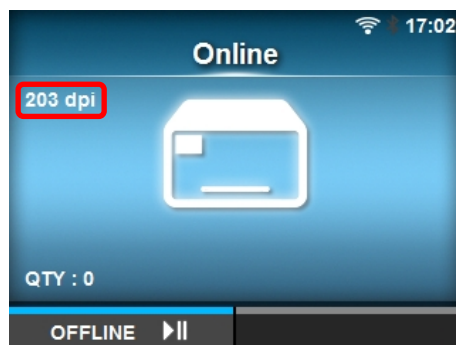

7. Select a printer port (COM) and click [Next].
The following illustration shows COM1 is selected as an example.

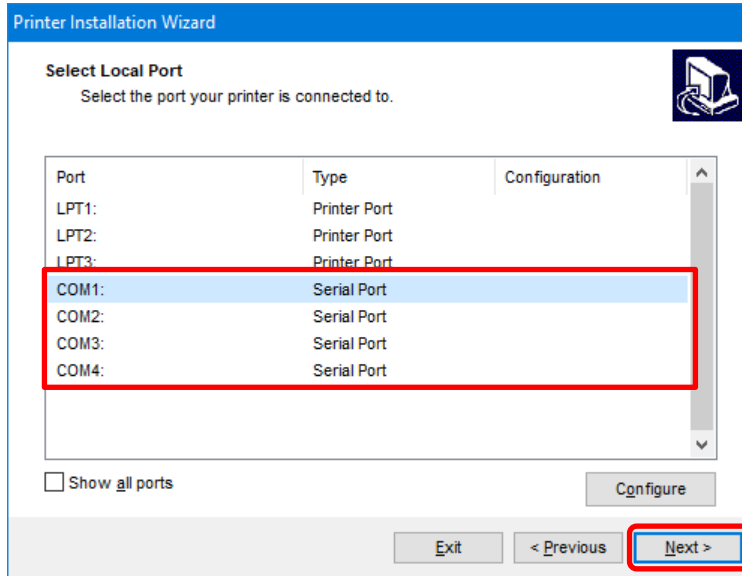

8. Click [Install].

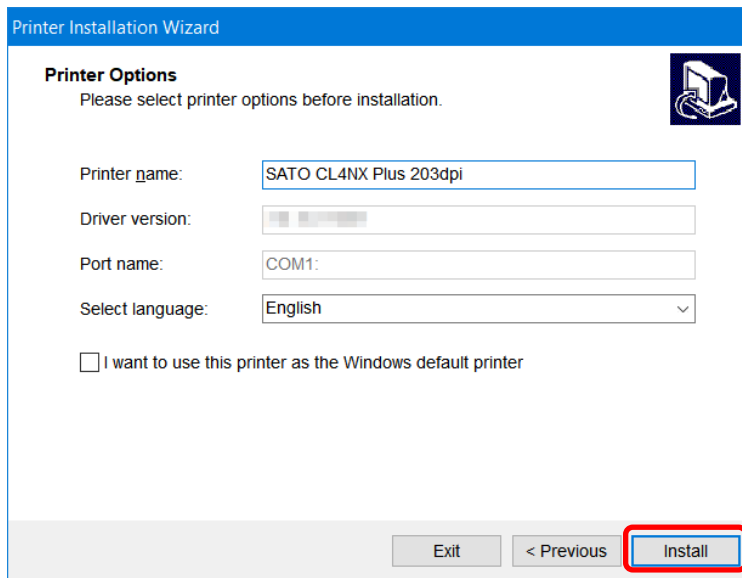

When the [Windows Security] screen appears, click [Install].

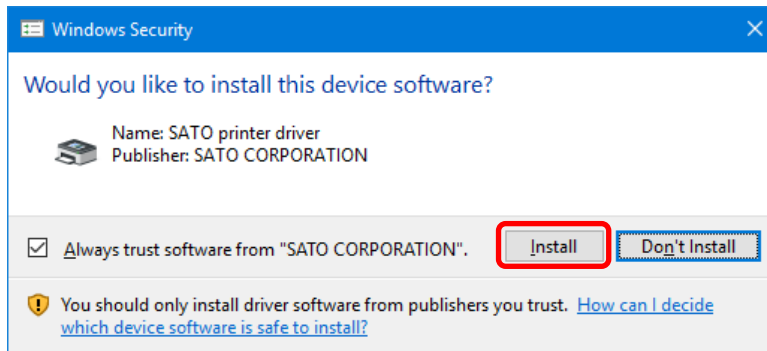

Note:

The warning screen above may not appear, depending on the version of the printer driver or your computer environment.

If a security warning screen indicating that another process is blocking access appears, follow the on-screen instructions.

9. Confirm that [succeeded] is shown for the installed printer driver and click [Exit].

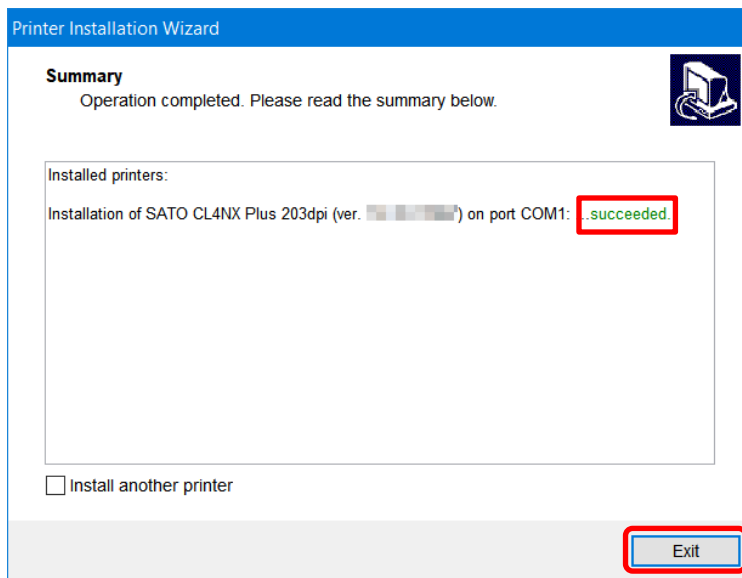

10. Open [Devices and Printers] and confirm that the printer driver has been added to the list of [Printers].

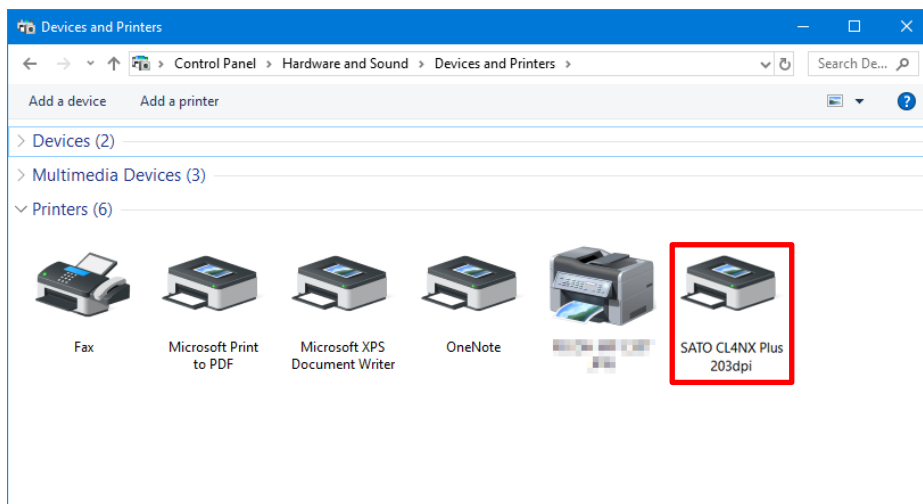

1.3.5 Installing the Printer Driver for Second and Later Products

When using multiple products, you need to install printer drivers for each product.

When Connected via USB or IEEE1284

1. Power off the product and connect the product to the computer.
 2. Power on the product.
The Plug and Play feature runs and the printer driver is automatically installed.
 3. If necessary, change the printer name.
-

Note:

You cannot install the printer driver as port and printer names that have already been created. Change the name(s).

When Connected via LAN, Wireless LAN or RS-232C

Use the same procedure as the first product to install the printer driver.

1. Double-click PrnInst.exe.
 2. To finish installing the printer driver, follow the same procedure as the first product.
-

Note:

You cannot install the printer driver as port and printer names that have already been created. Change the name(s).

When Connected via Bluetooth

Use the same procedure as the first product to install the printer driver.

1. Pair the product with the computer.
 2. Double-click PrnInst.exe.
 3. To finish installing the printer driver, follow the same procedure as the first product.
-

Note:

You cannot install the printer driver as port and printer names that have already been created. Change the name(s).

1.3.6 Manually Configuring Settings Necessary to Install the Printer Driver

This section describes how to install the printer driver by manually configuring the printer driver settings.

1. Click [Install Printer Driver].

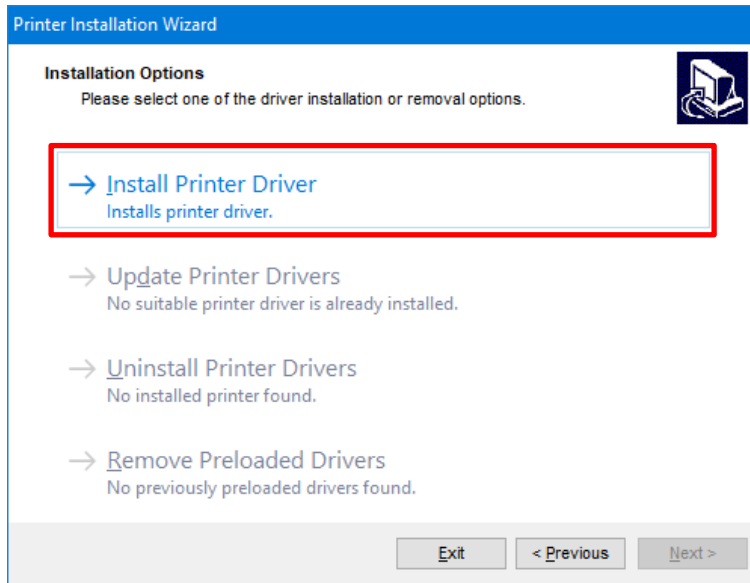

2. Click [Other].

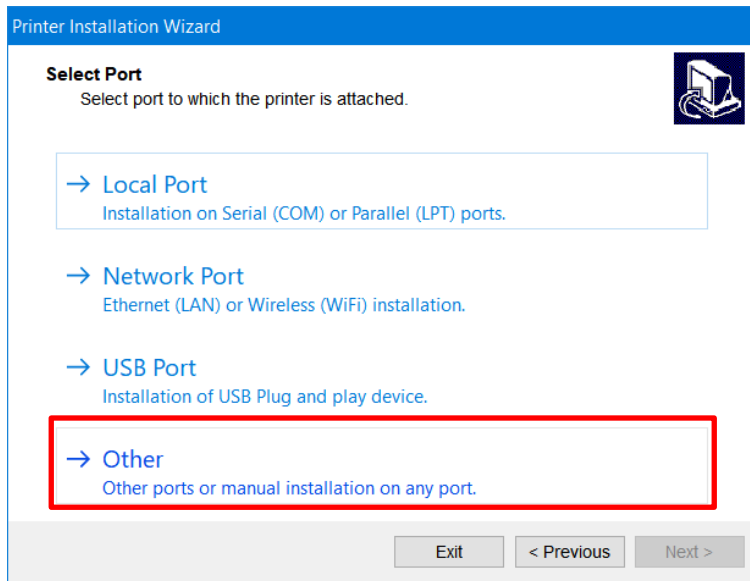

3. Select the model of the product and click [Next].

The following illustration shows SATO CL4NX PLUS 203dpi is selected as an example.

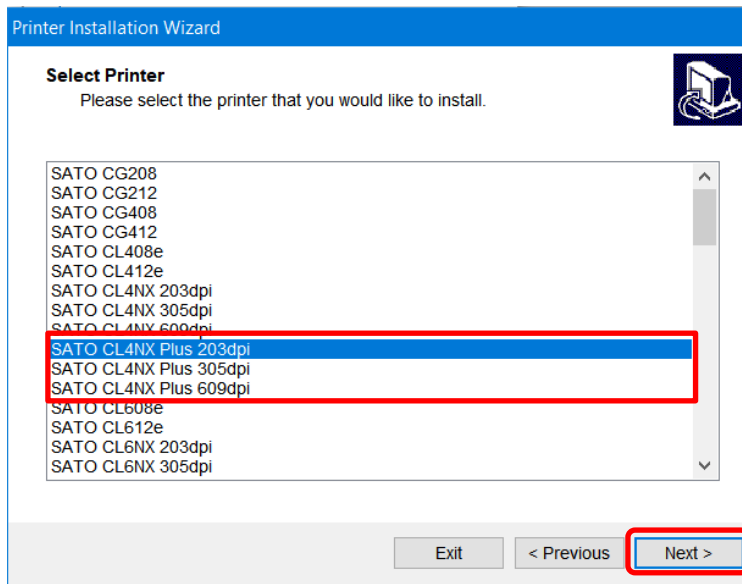

Note:

Select the model that is compatible with the resolution of the product. The resolution of the product is shown on the upper left of the Online/Offline screen.

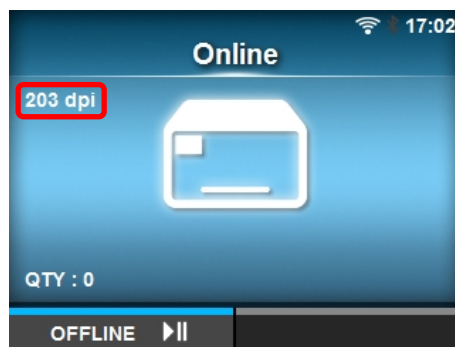

4. Click [Add Port].

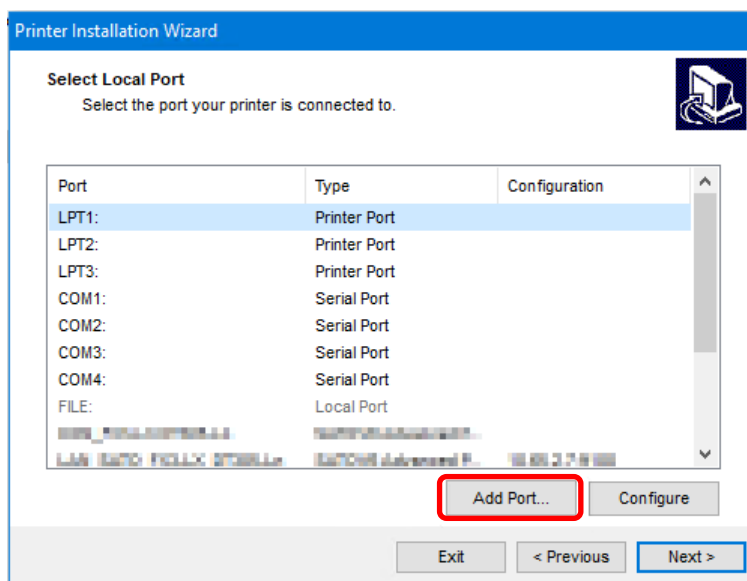

5. Select the port type that matches the product connection method from the [Select port type] drop down list and click [OK].

For LAN or wireless LAN connection: [TCP/IP (LAN)]

For Bluetooth or RS-232C connection: [SERIAL (COM)]

For IEEE1284 connection: [PARALLEL (LPT)]

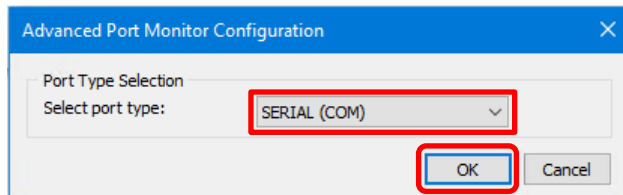

6. Configure the port settings and click [OK].

If you selected [TCP/IP (LAN)]

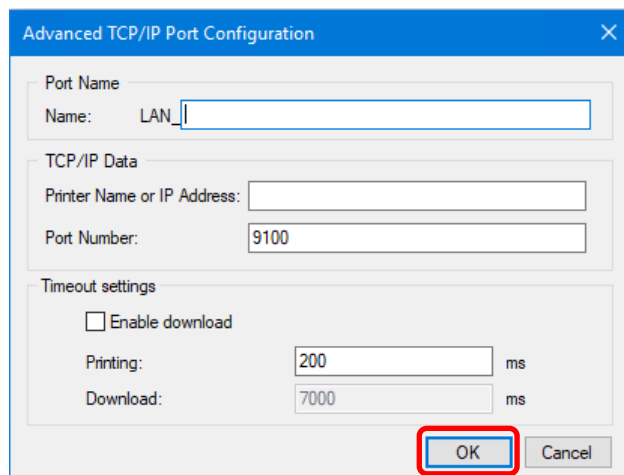

Note:

- You cannot set the same name as an existing port name.
- The computer cannot communicate with the destination product if the [Product Name or IP Address] and [Port Number] settings do not match those of the product.
- Click [OK] to check communications using the configured settings. If communications failed, the following screen appears.

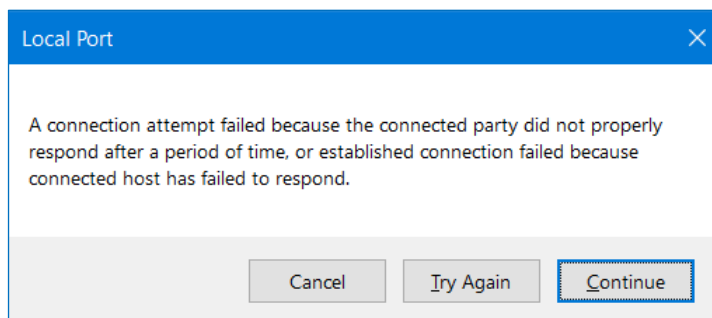

[Cancel]

Returns to the previous screen. Click this button to change [Printer Name or IP Address] or any other settings.

[Try Again]

Checks communications again.

[Continue]

Does not check communications and proceeds to the next step. Click this button when you want to continue with the port setup without checking communications with the product.

- Normally, you do not need to change [Port Number] (the default value on the product is also 9100).
- Normally, you do not need to change the timeout settings.
- The [Advanced TCP/IP Port Configuration] dialog box can be shown even after installing the printer driver with the following procedure:
 - a. Open [Devices and Printers], right-click the desired printer driver, and select [Printer properties].
 - b. Click the [Ports] tab.
 - c. Click [Configure Port].

If you selected [SERIAL (COM)]

Advanced Serial Port Configuration

Port Name
Name: COM_ CL4NX Plus

Serial Port Data
Serial port: COM4
Bits per second: 19200
Data bits: 8
Parity: None
Stop bits: 1
Flow control: None

Timeout settings
 Enable download
Printing: 200 ms
Download: 7000 ms

OK Cancel

Note:

- You cannot set the same name as an existing port name.
- Select the same port as the connected product for [Serial port].
- For [Flow control], select [None].

If you selected [PARALLEL (LPT)]

Advanced Parallel Port Configuration

Port Name
Name: LPT_

Parallel Port Data
Parallel port: LPT1

Timeout settings
 Enable download
Reception: 500 ms
Reception interval: 200 ms
Transmission: 3000 ms
Printing: 200 ms
Download: 7000 ms

OK Cancel

Note:

- You cannot set the same name as an existing port name.
- Select the same port as the connected product for [Parallel port].

7. Confirm that added port is selected and click [Next].

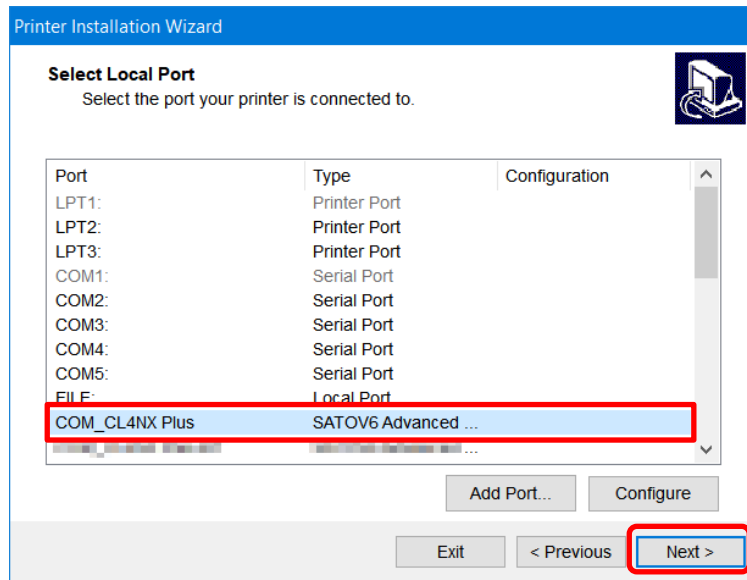

8. Click [Install].
If the same printer name exists, change [Printer name] and then click [Install].

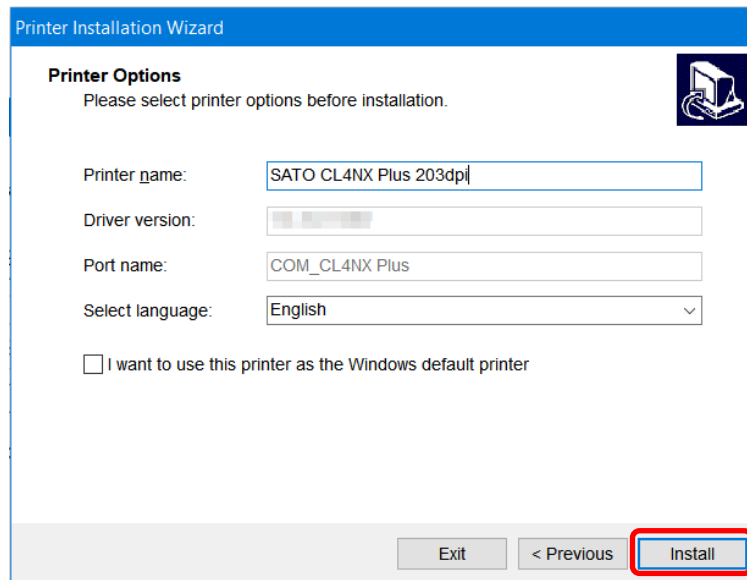

When the [Windows Security] screen appears, click [Install].

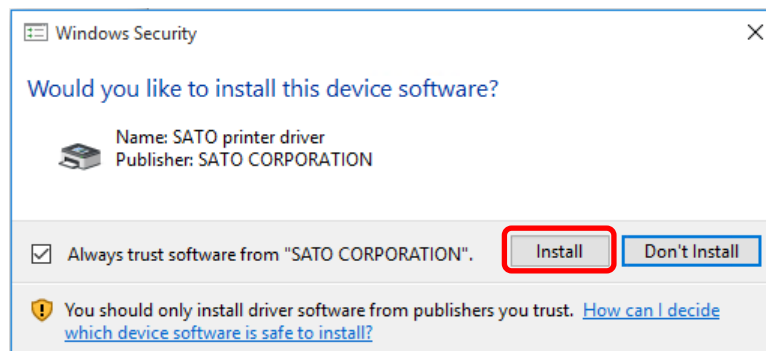

Note:

The warning screen above may not appear, depending on the version of the printer driver or your computer environment.

If a security warning screen indicating that another process is blocking access appears, follow the on-screen instructions.

9. Confirm that [succeeded] is shown for the installed printer driver and click [Exit].

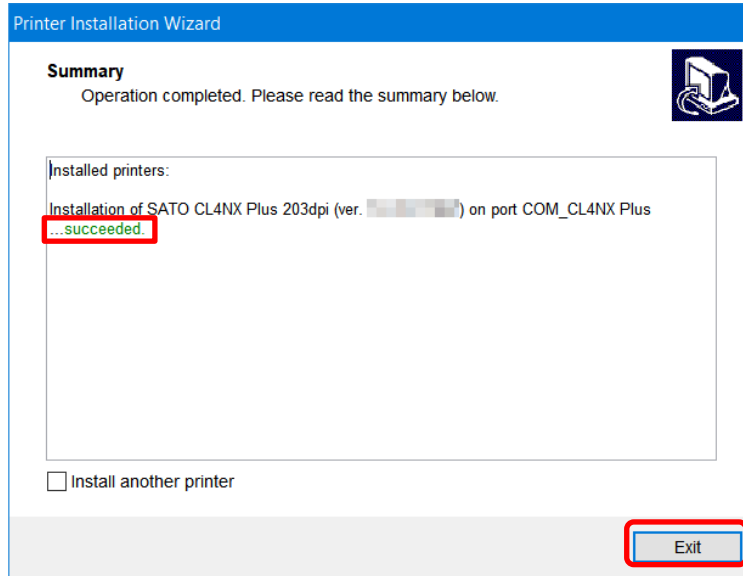

10. Open [Devices and Printers] and confirm that the printer driver has been added to the list of [Printers].

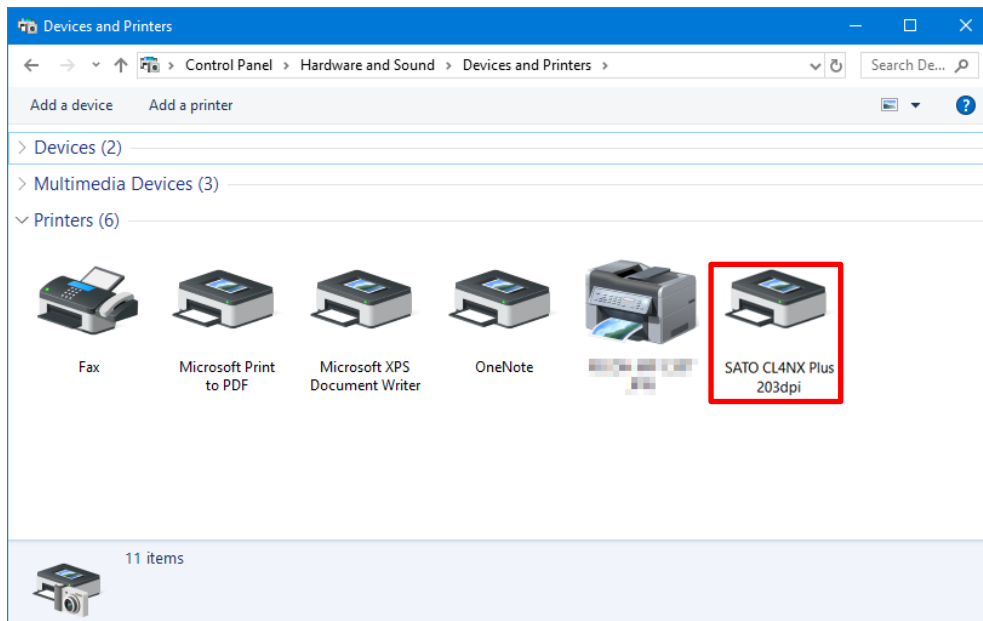

1.3.7 What to Do If the Printer Driver Is Added under [Unspecified]

If the printer driver is added under [Unspecified] in [Devices and Printers], it will not be recognized as a printer. Follow the procedure below to recognize it as a printer.

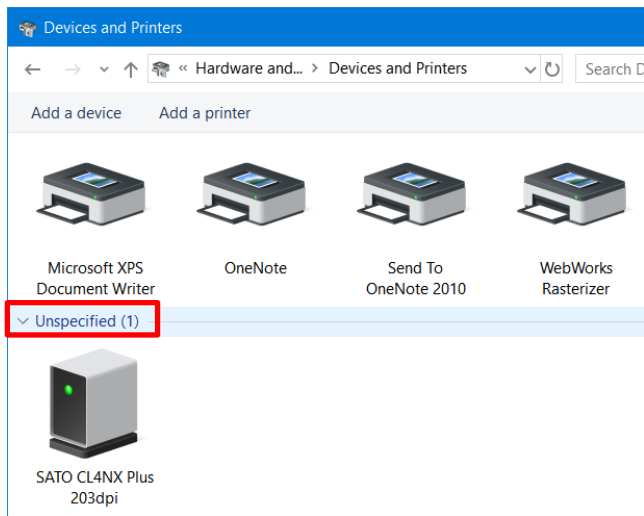

1. Open [Devices and Printers], right-click the printer driver added under [Unspecified], and select [Properties].

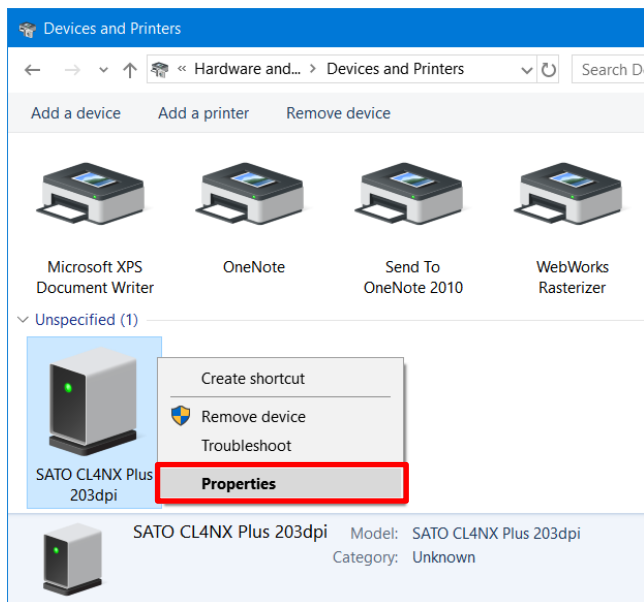

2. Select the [Hardware] tab.

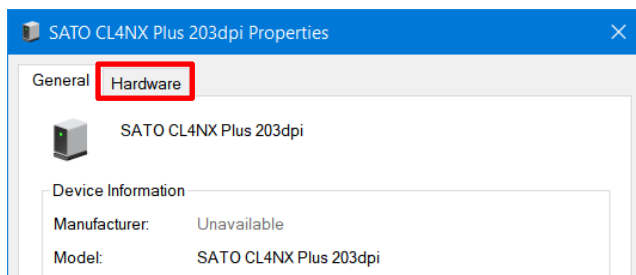

3. Select the name of the product in the list and click [Properties].

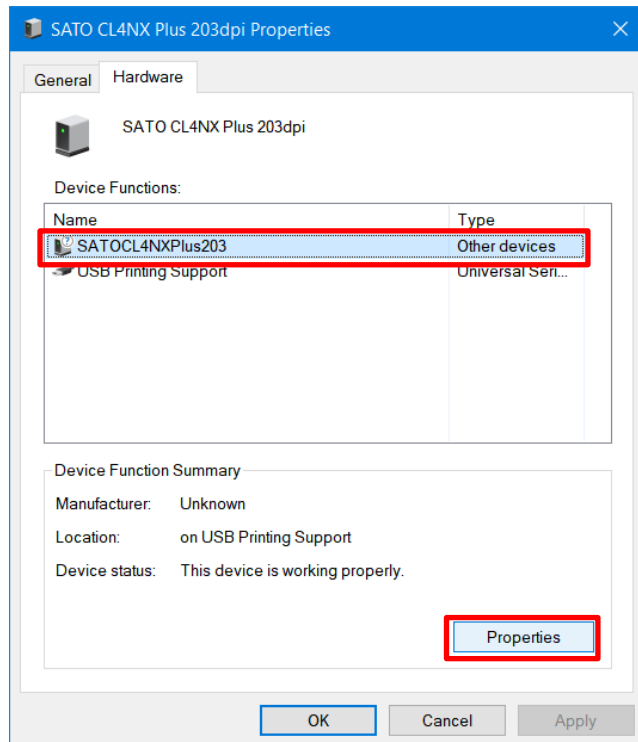

4. Click [Change settings].

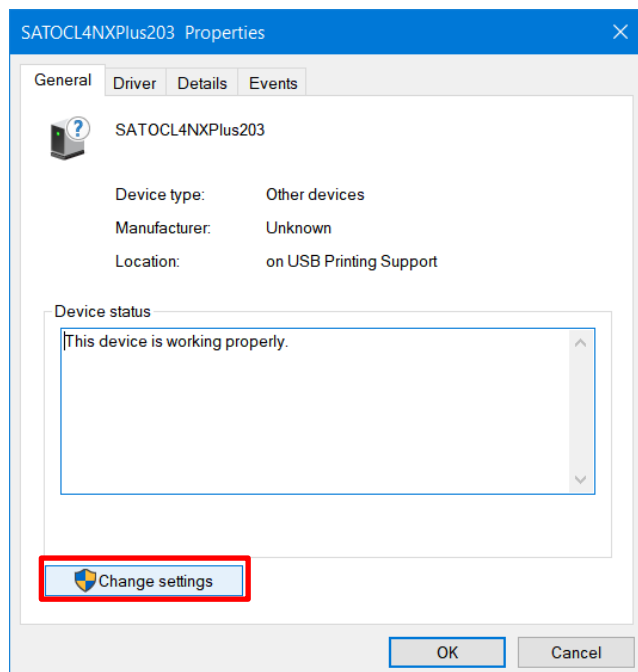

5. Select the [Driver] tab.

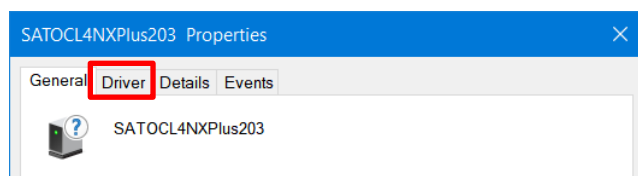

6. Click [Update Driver].

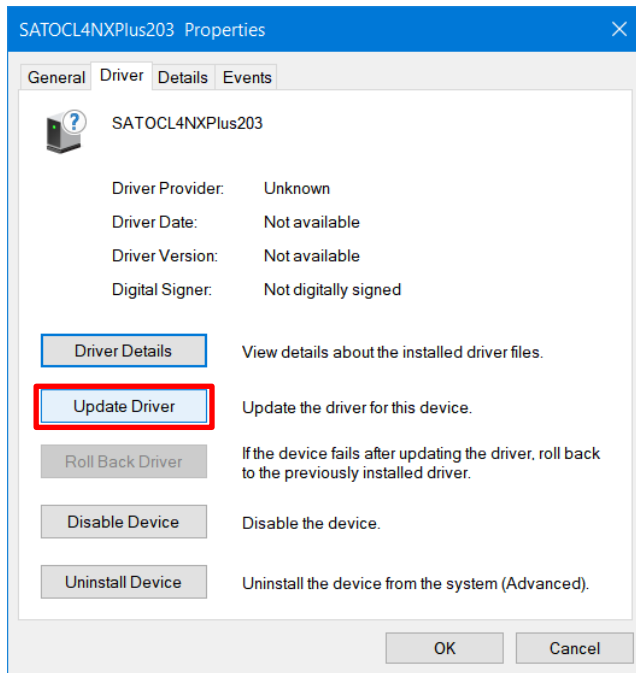

7. Click [Browse my computer for driver software].

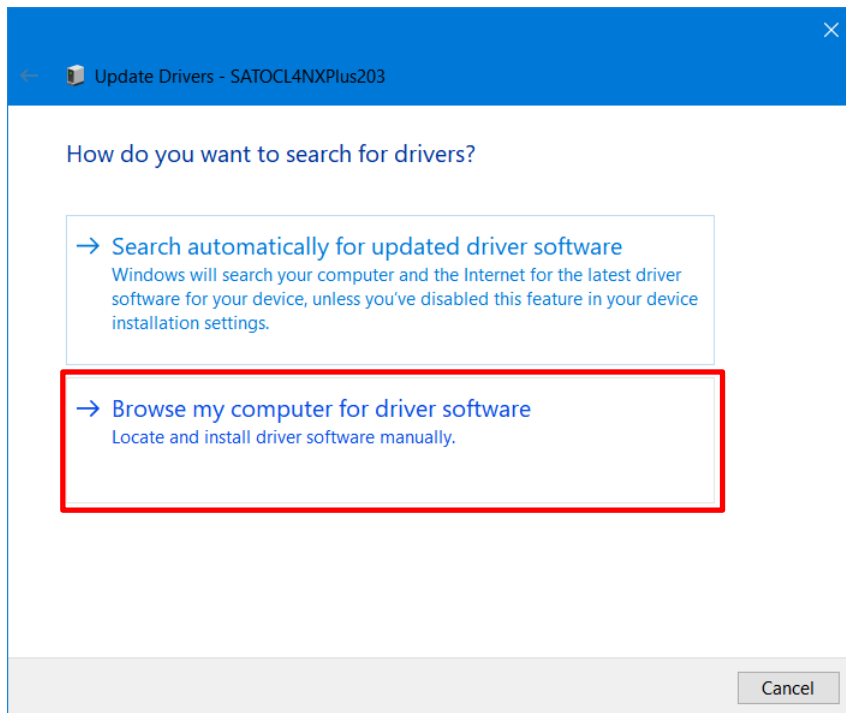

8. Click [Browse], specify the folder where the printer driver was extracted to, and click [Next].

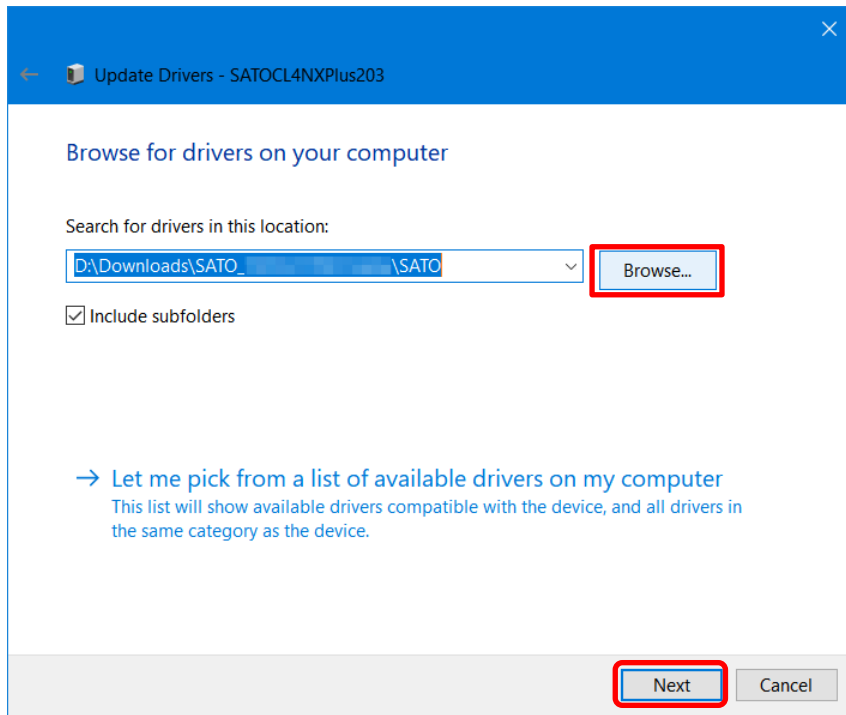

When the [Windows Security] screen appears, click [Install].

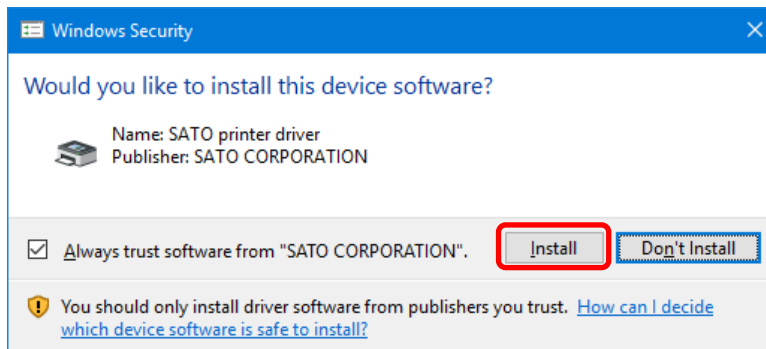

Note:

The warning screen above may not appear, depending on the version of the printer driver or your computer environment.

If a security warning screen indicating that another process is blocking access appears, follow the on-screen instructions.

9. Click [Close].

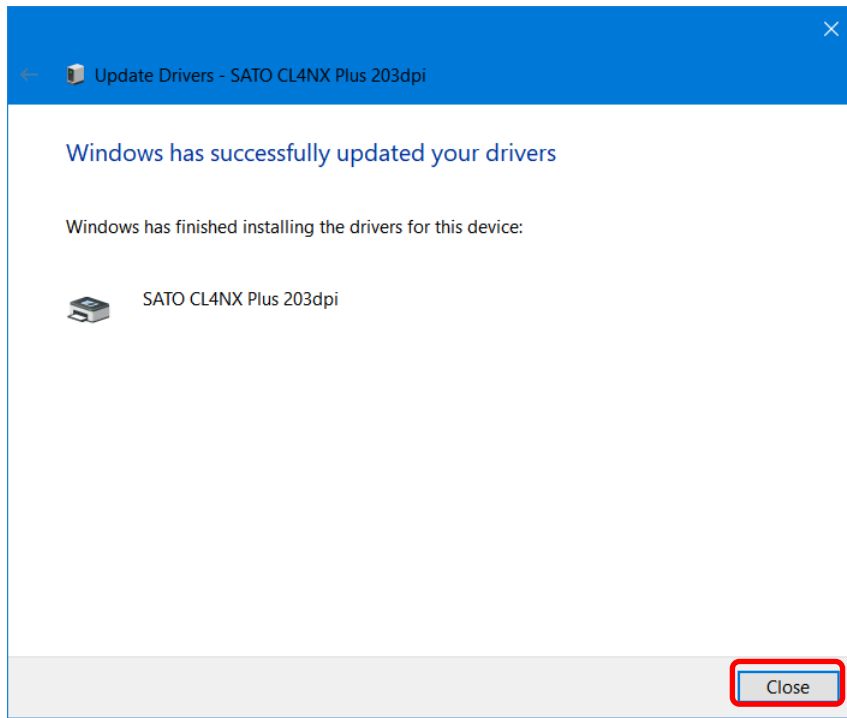

10. Confirm that the printer driver is shown under [Printers] in [Devices and Printers].

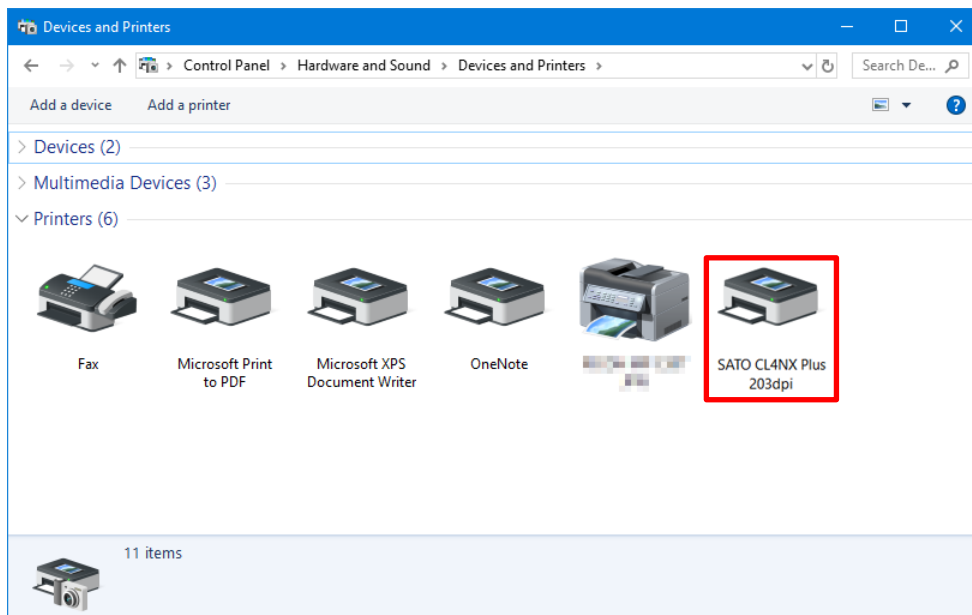

2. Setting Up the Printer Driver

After installing the printer driver, set up the printer driver as necessary.

2.1 [Printing Defaults] (For All Users) and [Printing Preferences] (For Individual Users)

There are two printer driver settings: [Printing Defaults], which is applied to all users, and [Printing Preferences], which is applied to users individually. While the settings and interface for [Printing Defaults] and [Printing Preferences] are the same, behavior differs.

[Printing Defaults]

This setting is used for an administrator to manage default values and settings of other users.

Settings changed in [Printing Defaults] are applied to [Printing Preferences] for other users.

The default values for [Printing Preferences] of newly added users are the settings for [Printing Defaults] at the time the user was added.

[Printing Preferences]

This setting is used to change individual user settings.

Settings changed in [Printing Preferences] do not affect the settings of other users. Settings changed in [Printing Preferences] take priority over settings in [Printing Defaults].

Opening [Printing Defaults]

1. Open [Devices and Printers], right-click the installed printer driver, and select [Printer properties].

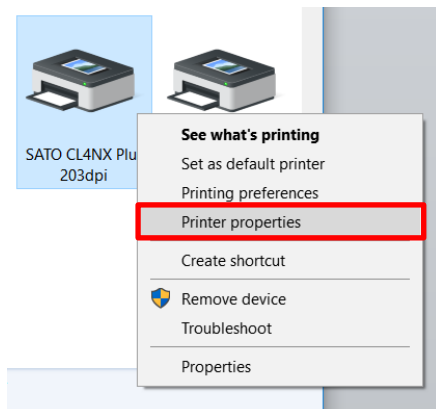

2. Click the [Advanced] tab and then [Printing Defaults].

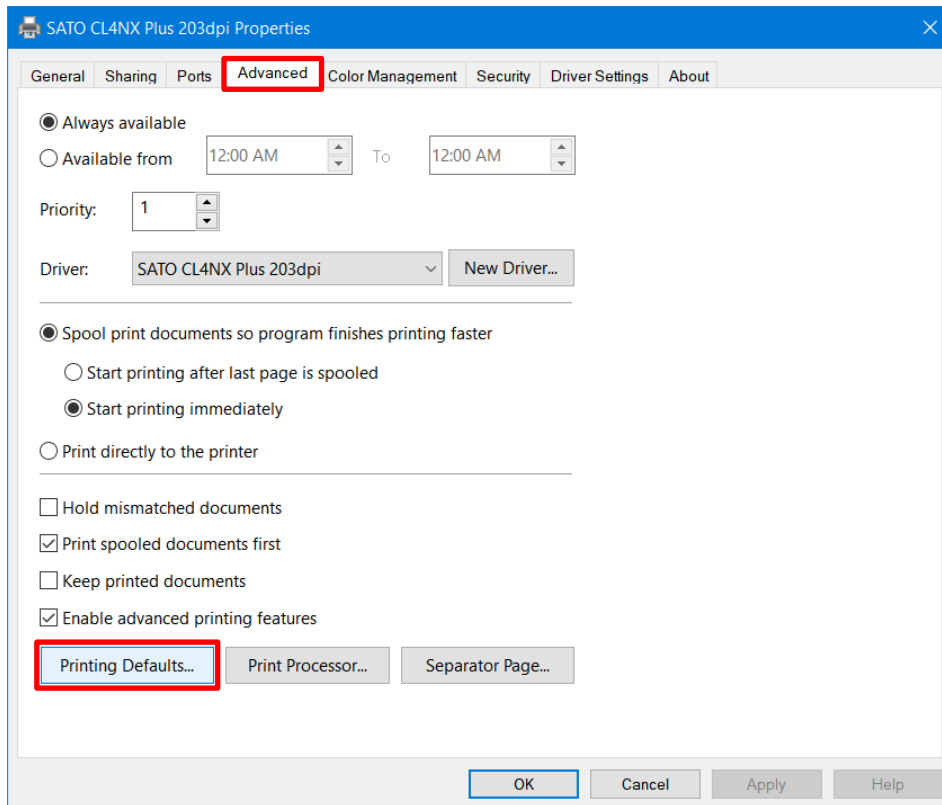

The [Printing Defaults] screen appears.

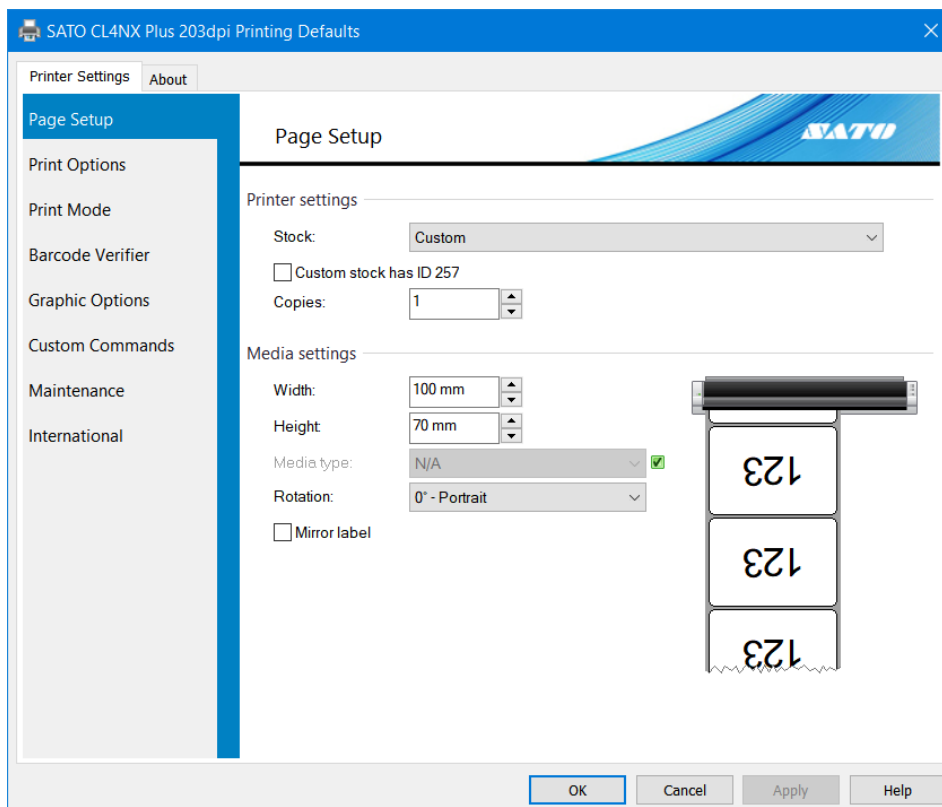

Opening [Printing Preferences]

1. Open [Devices and Printers], right-click the installed printer driver, and select [Printer properties].

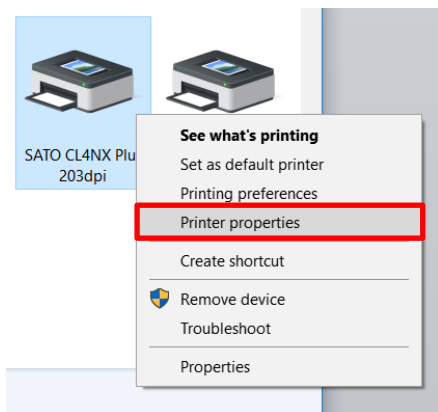

2. Click the [General] tab and then [Preferences].

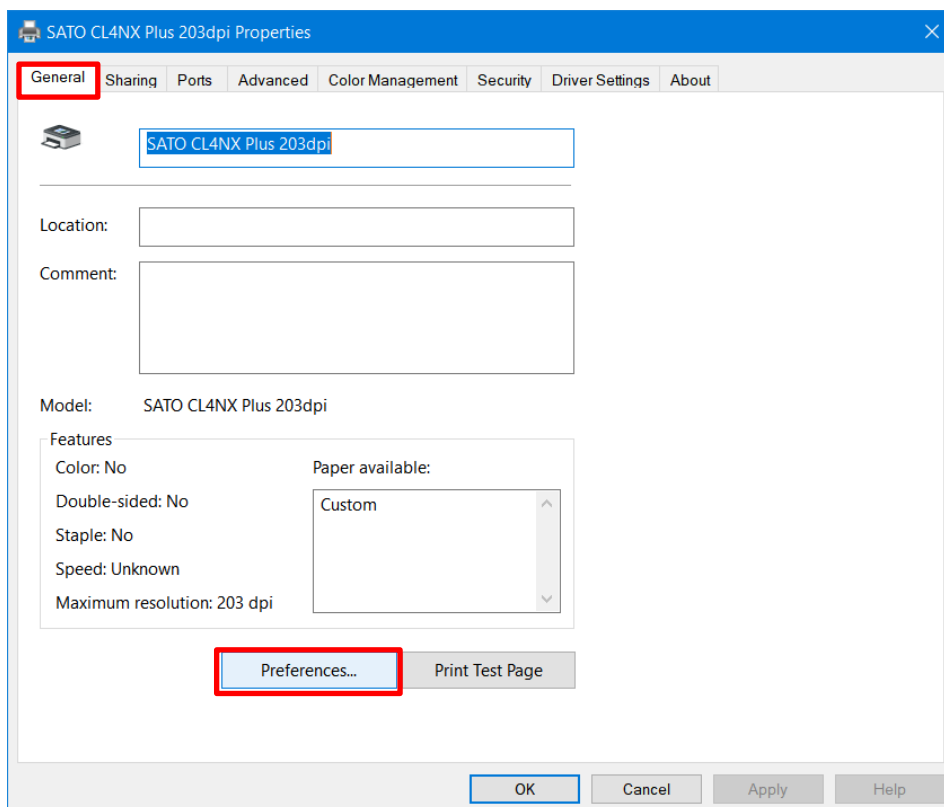

The [Printing Preferences] screen appears.

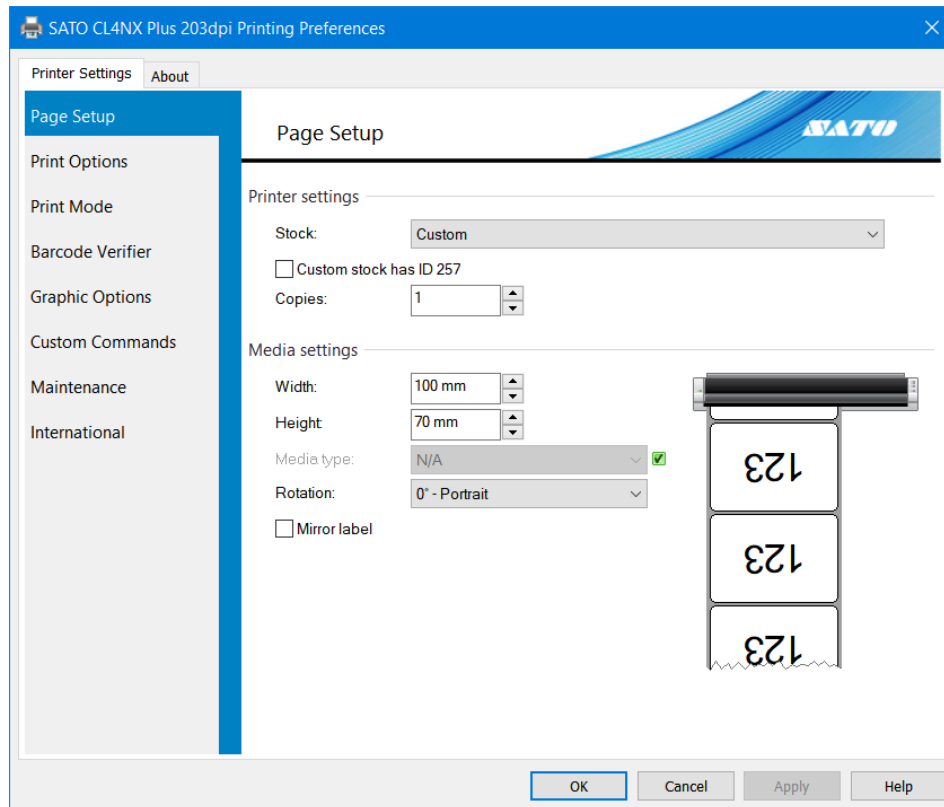

Note:

When you right-click the printer driver in [Devices and Printers] and select [Printing preferences], the same setting screen for the [Printing Preferences] appears.

2.2 How to Get Administrator Privileges

To change settings, add and change ports, administrator privileges are required.

Procedure on OSs Other Than Windows Server 2008

1. Open [Devices and Printers], right-click the desired printer driver, and select [Printer properties].
2. Click the [Sharing] tab and then [Change Sharing Options].

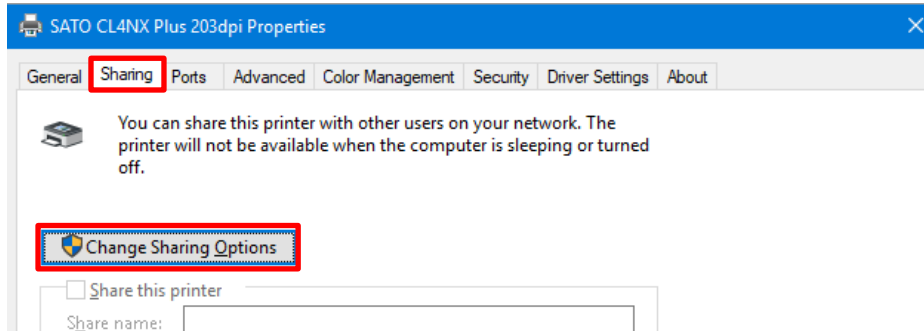

The [Printer Properties] screen will appear with administrator privileges.

What to do if [Change Sharing Options] is not shown

Perform the procedure below to display the button. This procedure is performed in Windows 10 as an example. Depending on the settings of the Windows version that you are using, the menu layout may be different. You may also not be able to change settings.

- a. Open Start icon > [All apps] > [Windows System] > [Control Panel] > [Choose homegroup and sharing options] or [HomeGroup] > [Change advanced sharing settings].
- b. Under [File and printer sharing] in [Home or Work (or Public or Domain) (current profile)], select [Turn off file and printer sharing], then click [Save changes].

Procedure on Windows Server 2008

1. Open [Printers], right-click the desired printer driver, and select [Run as administrator] > [Properties].

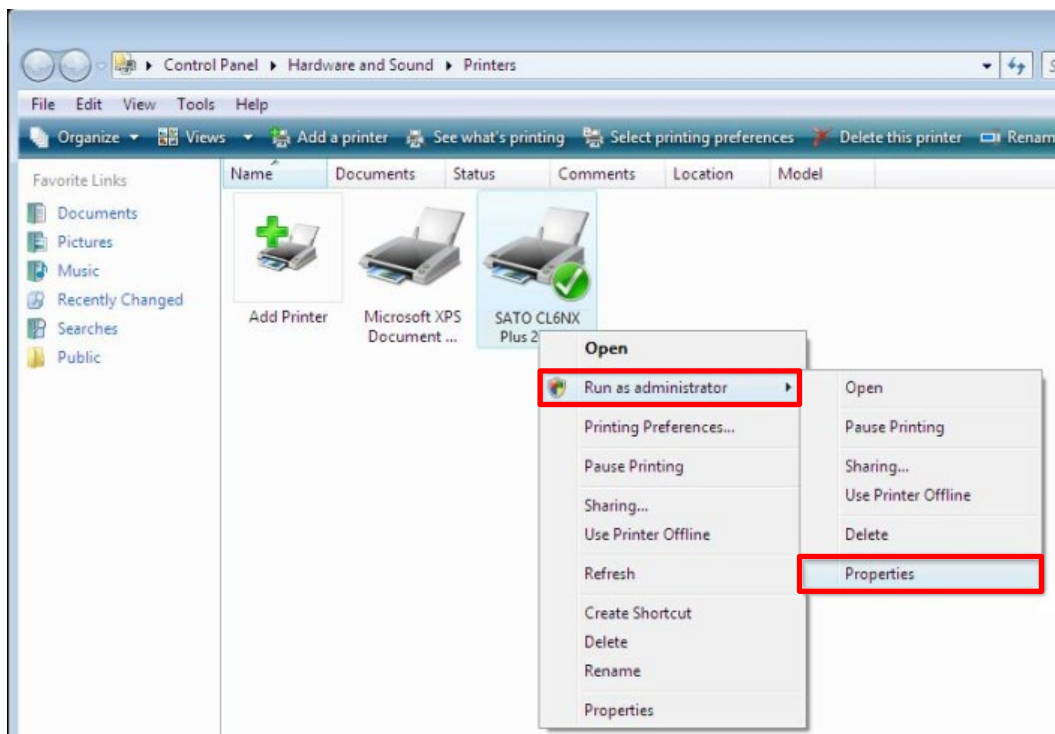

3. Settings on the [Driver Settings] Tab

You can configure various settings for the product on the [Driver Settings] tab on the [Printer Properties] dialog box.

The settings on the [Driver Settings] tab are shared with all users who use the computer that the printer driver is installed on.

Displaying the [Driver Settings] Tab

1. Open [Devices and Printers], right-click the desired printer driver, and select [Printer properties].
2. Click the [Driver Settings] tab.

3.1 Stocks

You can register the media size, print speed, and other settings in a lump. By registering the settings in advance, you can easily configure settings in accordance with the media.

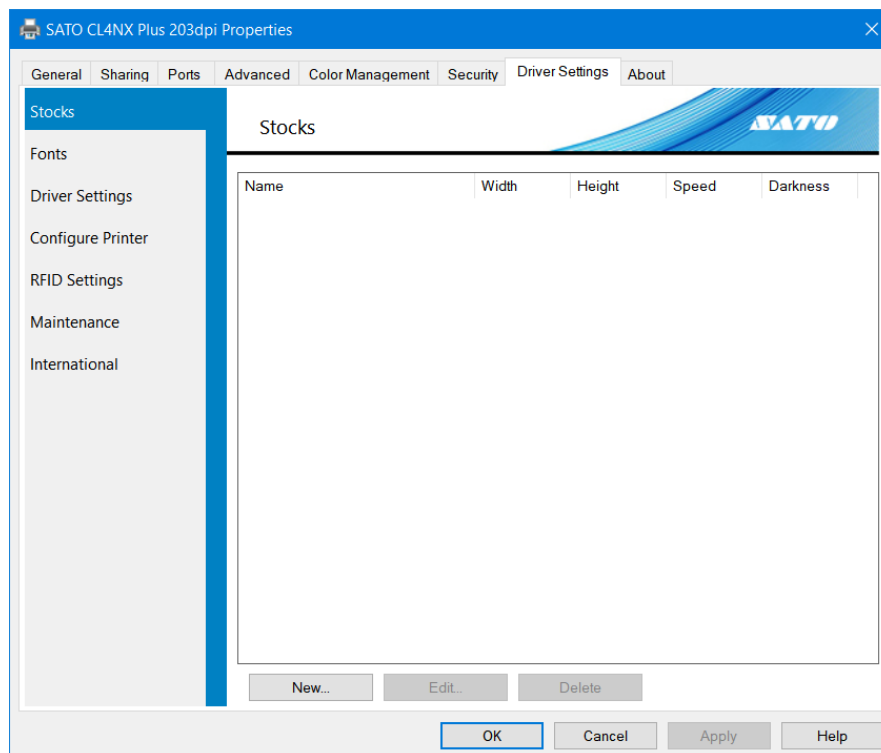

[New]

Register a new stock.

[Edit]

Edit the details of registered stock.

[Delete]

Delete registered stock.

3.1.1 Page Setup

This screen is shown when you click [New] or [Edit] on the [Stocks] screen.

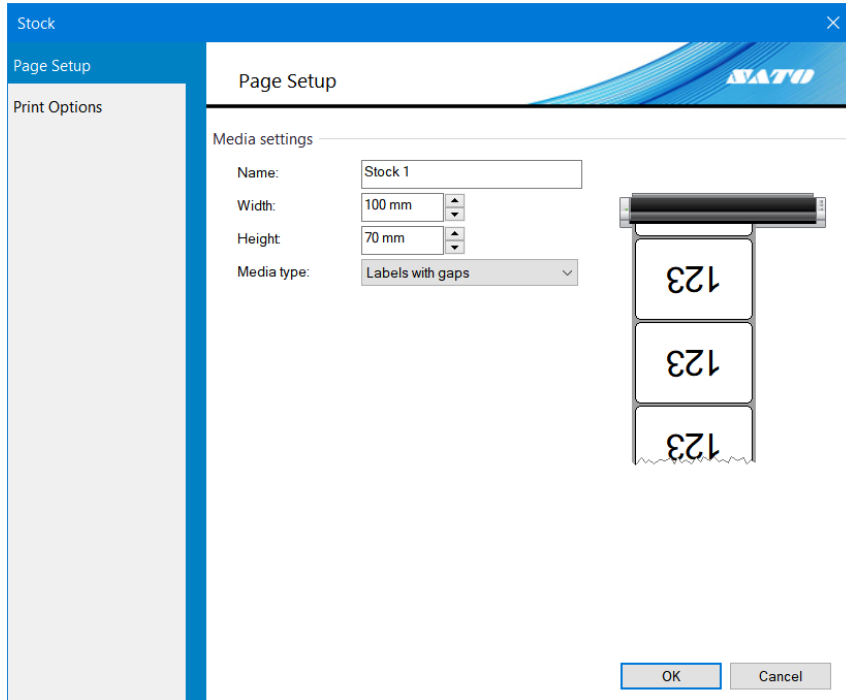

[Name]

Set or edit the name of the stock.

[Width]

Set the media width that includes the liner.

[Height]

Set the media height that includes the liner.

[Media type]

For the sensor type to detect the top of the media, you can select [Labels with gaps], [Labels with black marks], or [Continuous labels].

If you select [Continuous labels], the top of the media will not be detected and only the print length will always be fed.

3.1.2 Print Options

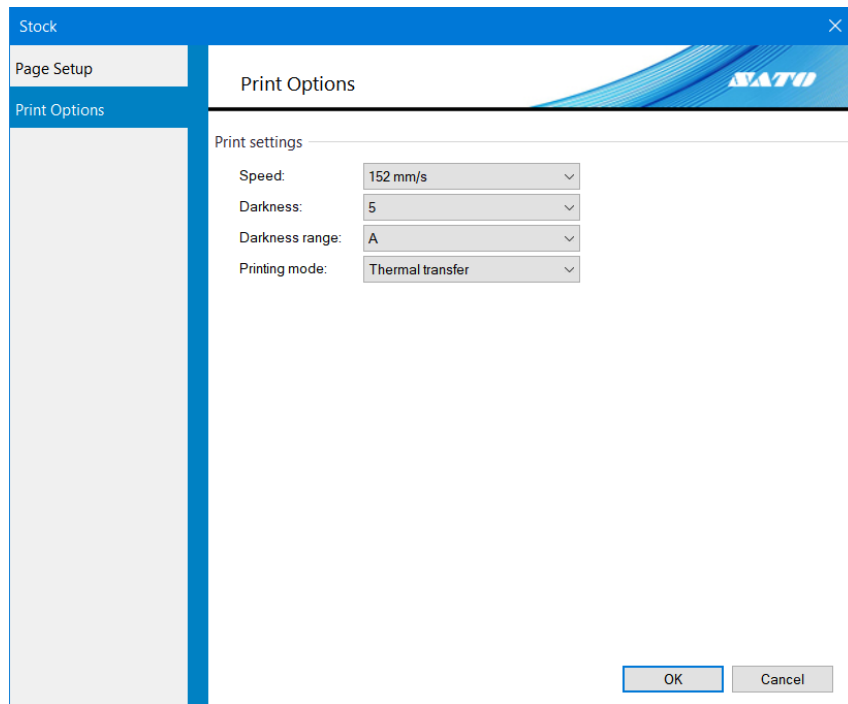

[Speed]

This shows the print speed for the stock that you set on the [Page Setup] screen.

[Darkness]

This shows the print darkness for the stock that you set on the [Page Setup] screen.

You can set 10 levels, from [1] to [10]. The bigger the number, the darker the print result.

[Darkness range]

This shows the print darkness range for the stock that you set on the [Page Setup] screen.

For details, refer to "CL4NX Plus Operator Manual."

[Printing mode]

This shows the printing mode for the stock that you set on the [Page Setup] screen.

You can set [Thermal transfer] or [Direct thermal].

3.2 Fonts

You can manage barcode fonts, command fonts, and substitution fonts on this screen.

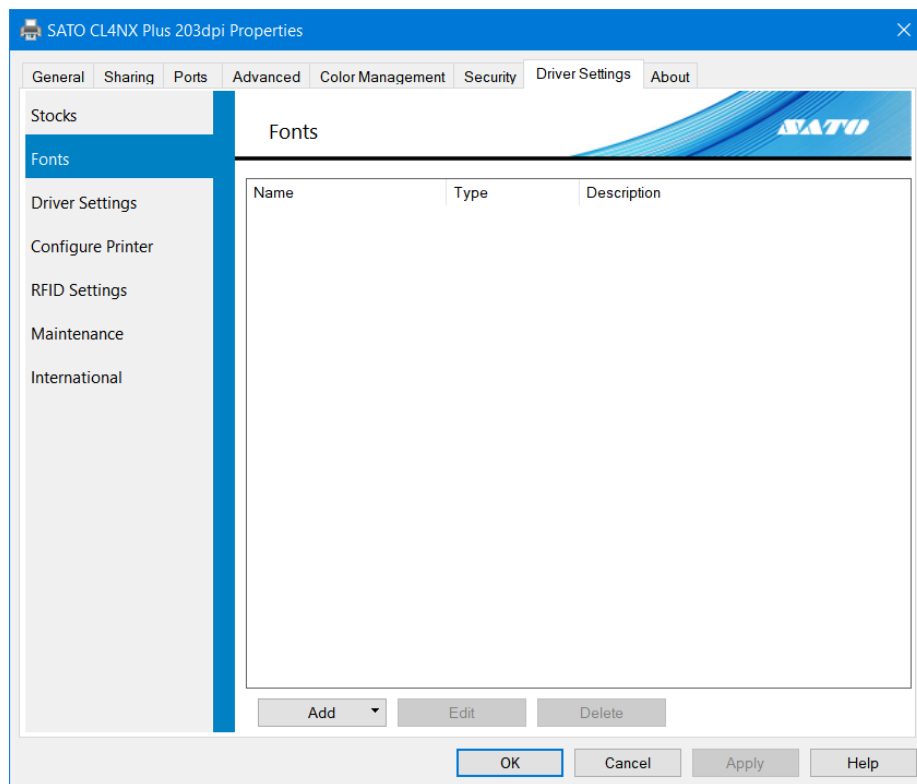

[Add]

Select the fonts to add from [Barcode], [Command], and [Substitution].

[Edit]

Edit the settings of registered fonts.

[Delete]

Delete registered fonts.

3.2.1 Barcode Font Settings and Usage Example

Barcode font is a feature that, by applying it on a string on documents in an application, converts that string to a barcode and prints it.

The string is not shown as a barcode on the edit or preview screens in applications.

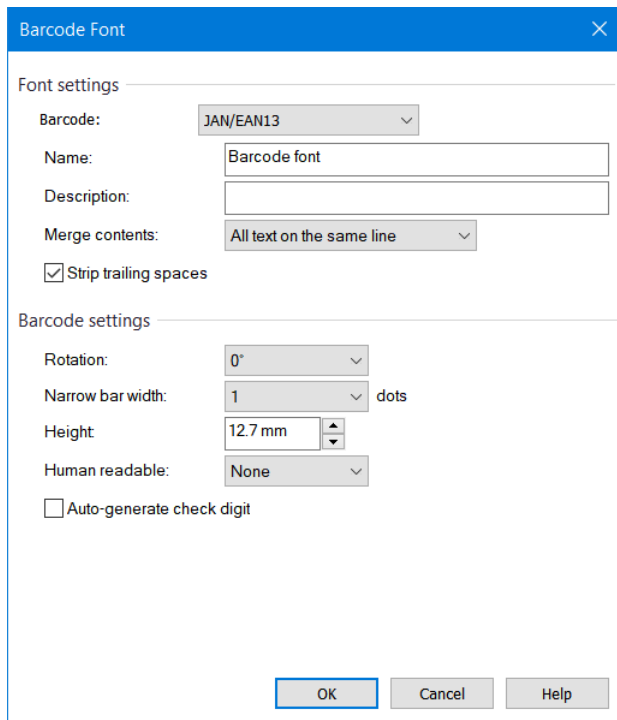

[Barcode]

Select a type of barcode or 2D code that you want to register.

[Name]

Set the name of the barcode font that you want to register. The name that you set here is shown on the font list in the application.

[Description]

Enter the description of the barcode font that you want to register.

[Merge contents]

This setting is used to apply commands only the appropriate number of times to objects divided multiple times in lines or on the page.

[No merge]: Any special processing is not performed.

[All text on the same line]:

Apply to text that have the same Y coordinates only once using the same font.

The result is that, even if one line of text is divided into multiple characters, it is applied only once.

[All text on the same page]:

Apply to all text on the same label only once using the same font.

This setting is used to apply commands to serial data like initialization and end processing only once.

Depending on the [Barcode] type, the following settings vary.

[Rotation]

Select [0°], [90°], [180°], or [270°] as the angle to print barcodes and 2D codes.

[Narrow bar width]

Specify the bar width for narrow bars.

This setting may not appear depending on the barcode type.

[Height]

Specify the height of the barcode.

[Human readable]

Specify how to append human readable text (comments).

[Auto-generate check digit]

Selecting this check box enables a check digit to be automatically generated.

Barcode Font Usage Example

This example shows how to add the "Code-39" barcode font and use it in an application.

1. Open [Devices and Printers], right-click the printer driver, and select [Printer properties].
2. Select [Fonts] on the [Driver Settings] tab and then select [Add] > [Barcode].

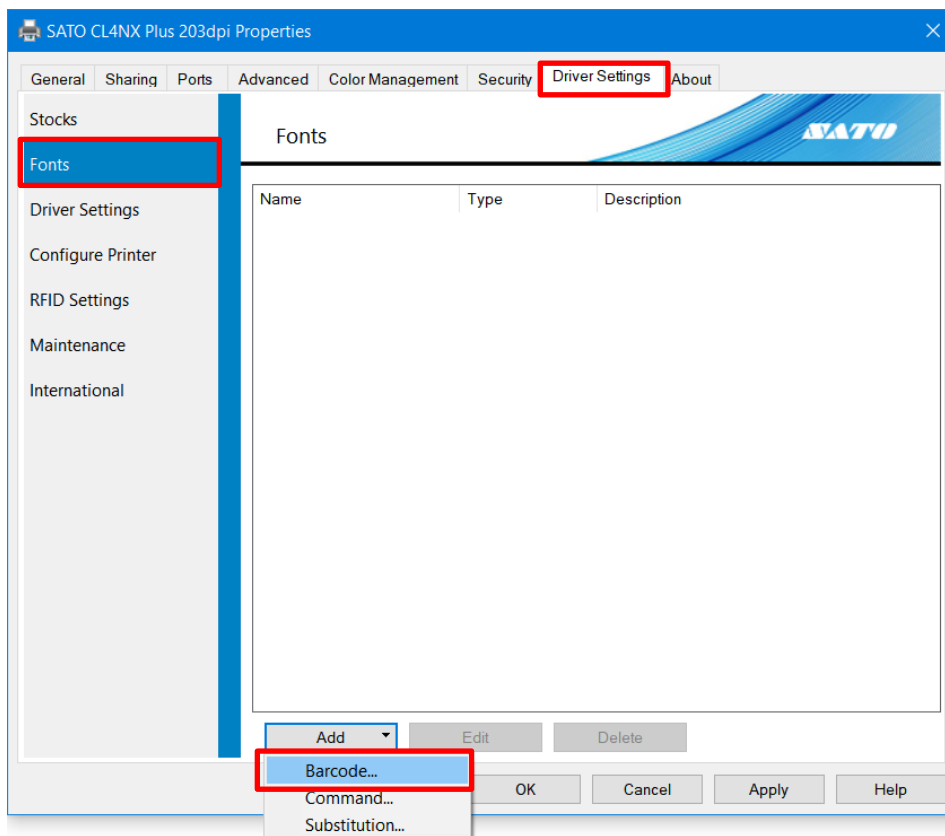

3. Configure the following settings and click [OK]:
[Barcode]: [Code-39]
[Name]: E.g., "SATO_Code39"

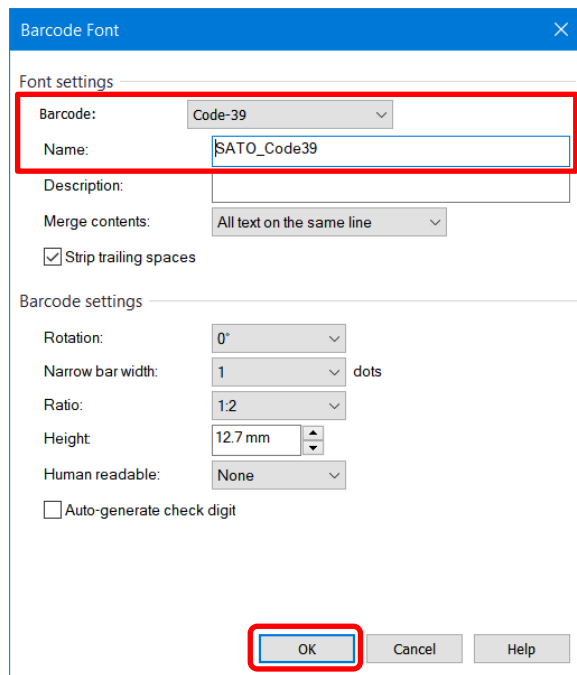

The image shows a 'Barcode Font' dialog box with the following settings:

- Barcode: Code-39
- Name: SATO_Code39
- Description: (empty)
- Merge contents: All text on the same line
- Strip trailing spaces
- Barcode settings:
 - Rotation: 0°
 - Narrow bar width: 1 dots
 - Ratio: 1:2
 - Height: 12.7 mm
 - Human readable: None
 - Auto-generate check digit

The 'OK' button is highlighted with a red box.

4. Confirm that the name you set for the barcode font is registered and click [OK].

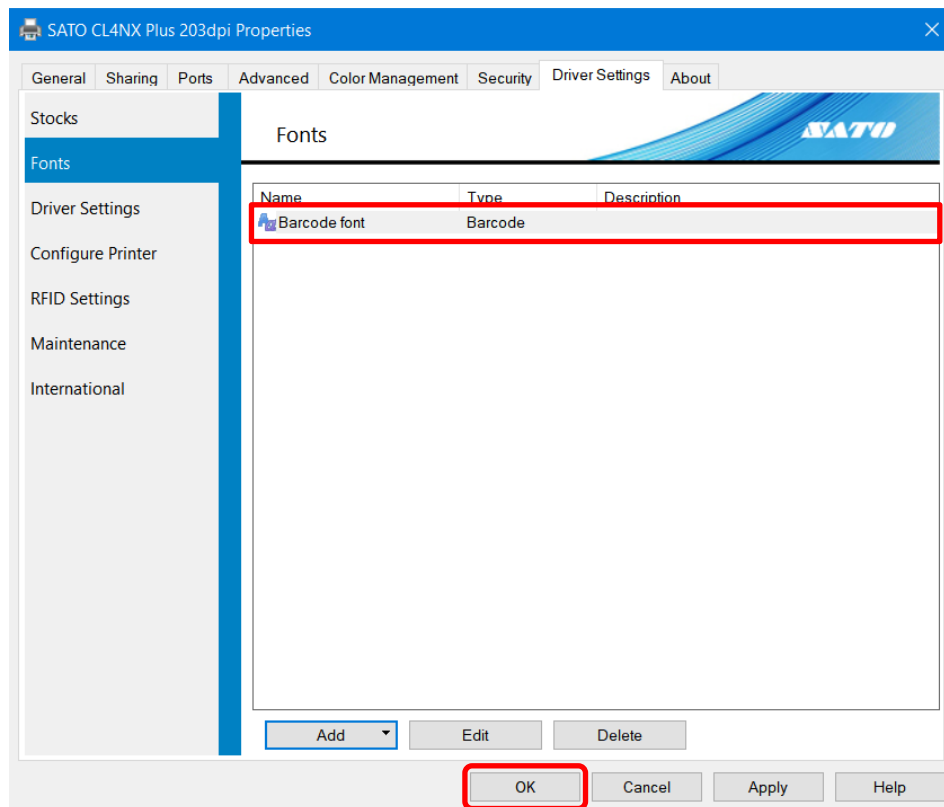

The image shows the 'SATO CL4NX Plus 203dpi Properties' dialog box, specifically the 'Fonts' tab. The 'Fonts' list contains one entry:

Name	Type	Description
Barcode font	Barcode	

The 'Barcode font' entry is highlighted with a red box. The 'OK' button is also highlighted with a red box.

5. Start the application and specify the product that you set the barcode font for as the printer to be used.

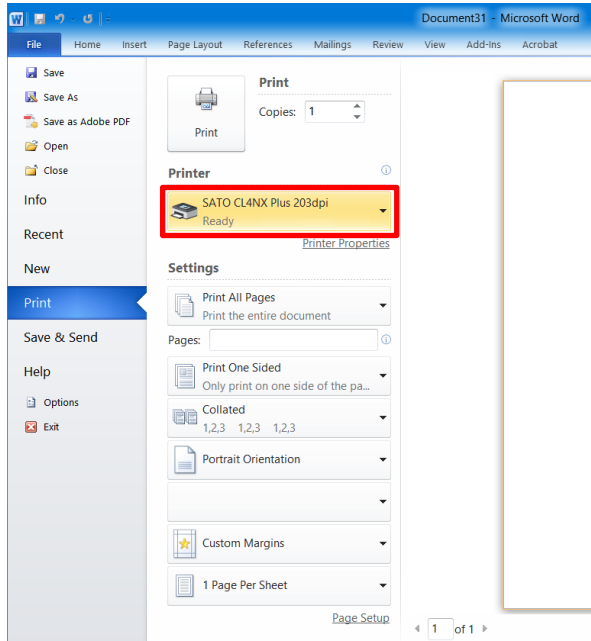

6. Enter the text that you want to convert into a barcode in the application and specify [SATO_Code39] as the text font.

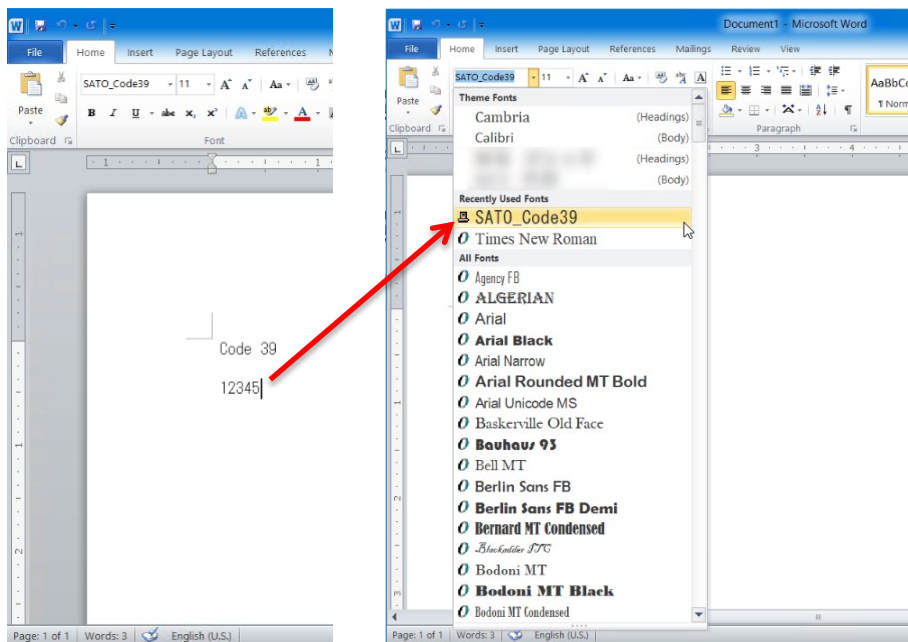

In this example, "12345" will be converted to a barcode. On the application, a line feed will be appended to the end of "12345". Set "12345" as the barcode font without the line feed.

7. Print the barcode.

The print result is shown below. The numbers "12345" specified as the CODE39 barcode font are printed as a CODE39 barcode.

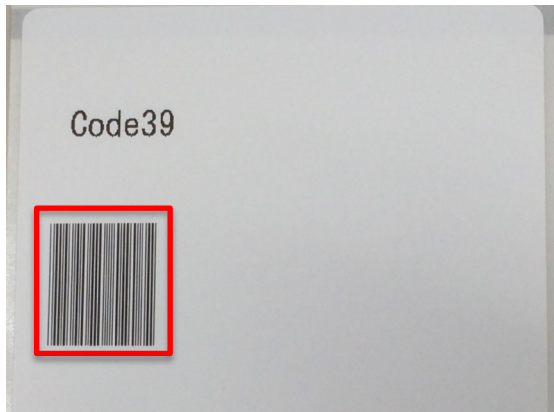

Note:

- Some characters cannot be used and there are text length restrictions depending on the barcode type set as the barcode font. Moreover, if the settings are not configured correctly, the text may not be printed as a barcode. For the data specifications that correspond to the barcode type, refer to "CL4NX Plus Programming Reference."
 - The string is not shown as a barcode on the edit or preview screens in applications.
 - If you cannot select registered barcode font in the application, make sure that the barcode font is registered in the printer driver to be used for printing.
 - The font size has nothing to do with the barcode size. Adjust the data so that it fits into the application layout.
 - If the converted barcode does not fit onto the page, it will not be printed. Adjust the position of the data on the application or adjust the barcode font settings so that the barcode fits onto the media.
-

3.2.2 Command Font Settings and Usage Example

Command font is a virtual font for directly sending commands to the product. You can use features that are not directly supported by the printer driver. Knowledge of SATO Barcode Printer Language (SBPL) command is necessary to use command font. For details on SBPL commands, refer to "CL4NX Plus Programming Reference."

The screenshot shows the 'Command Font' dialog box. It has a blue title bar with the text 'Command Font' and a close button (X). The dialog is divided into several sections:

- Command font:** A section with two text input fields. The 'Name' field contains 'Command font'. The 'Description' field is empty.
- Prefix:** A section with a 'Type' dropdown menu set to 'No prefix' and a 'Contents' text area that is empty.
- Suffix:** A section with a 'Type' dropdown menu set to 'No suffix' and a 'Contents' text area that is empty.
- Options:** A section with two dropdown menus. The 'Position' dropdown is set to 'Element position'. The 'Merge contents' dropdown is set to 'All text on the same line'.

At the bottom of the dialog are three buttons: 'OK', 'Cancel', and 'Help'.

[Name]

Set the name of the command font that you want to register.

This name is shown on the font list in the application.

[Description]

You can enter a description of the command font to be registered.

[Prefix] [Suffix]

Specify how the text is to be supplied. The specified text can be appended to the front or the end of a command.

[No prefix]: A prefix is not used.

[No suffix]: A suffix is not used.

[File]: Prefixes and suffixes are loaded from an external file and appended to the data.

[Parsed file]:

Prefixes and suffixes are loaded from an external file and appended to the data. Reserved variables can be included and are converted to data during printing.

[Text]: Prefixes and suffixes are appended directly as text.

[Parsed text]:

Prefixes and suffixes are appended directly as text. Reserved variables can be included and are converted to data during printing.

[Position]

You can control the position that the command font is inserted into the print data.

[Before page]: The command is inserted before the page starts.

[Before elements]: The command is inserted after the page starts and in front of all objects.

[Element position]: The command is inserted at the position of the object.

[After elements]: The command is inserted after all the objects and before the page ends.

[After page]: The command is inserted after the page ends.

[Merge contents]

This setting is used to apply commands only the appropriate number of times to objects divided multiple times in lines or on the page.

[No merge]: Any special processing is not performed.

[All text on the same line]:

Apply to text that have the same Y coordinates only once using the same font. This setting is applied even if one line of text is divided into multiple characters.

[All text on the page]:

Apply to all text on the same label only once using the same font. This setting is used to apply text to serial data like initialization and end processing.

Command Font Usage Example

This example shows how to add X21 printer device font as the font name "SATO Command Font" and use it in an application.

1. Open [Devices and Printers], right-click the printer driver, and select [Printer properties].
2. Select [Fonts] on the [Driver Settings] tab and then select [Add] > [Command].

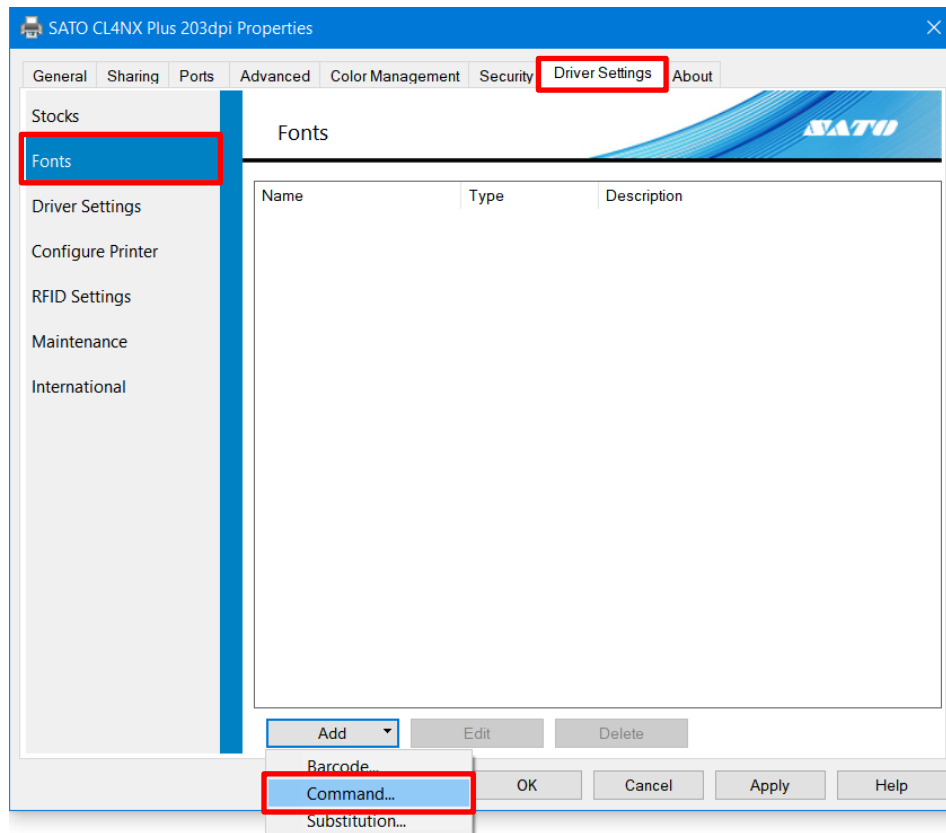

3. Configure the following settings and click [OK]:

Command font

[Name]: E.g., "SATO Command Font"

Prefix

[Type]: [Parsed text]

[Contents]: E.g., "<ESC>V<Y><ESC>H<X><ESC>X21,"

<ESC> is 1B in hexadecimal.

<ESC>, <Y>, and <X> can be entered with the keyboard. You can also select them from a list by clicking [>] on the right of [Contents].

Suffix

[Type]: [Text]

[Contents]: E.g., "678"

The image shows a 'Command Font' dialog box with the following configuration:

- Command font:**
 - Name: SATO Command Font
 - Description: (empty)
- Prefix:**
 - Type: Parsed text
 - Contents: <ESC>V<Y><ESC>H<X><ESC>X21
- Suffix:**
 - Type: Text
 - Contents: 678
- Options:**
 - Position: Element position
 - Merge contents: All text on the same line

Buttons: OK, Cancel, Help. The 'OK' button is highlighted with a red box.

4. Confirm that the command font is registered and click [OK].

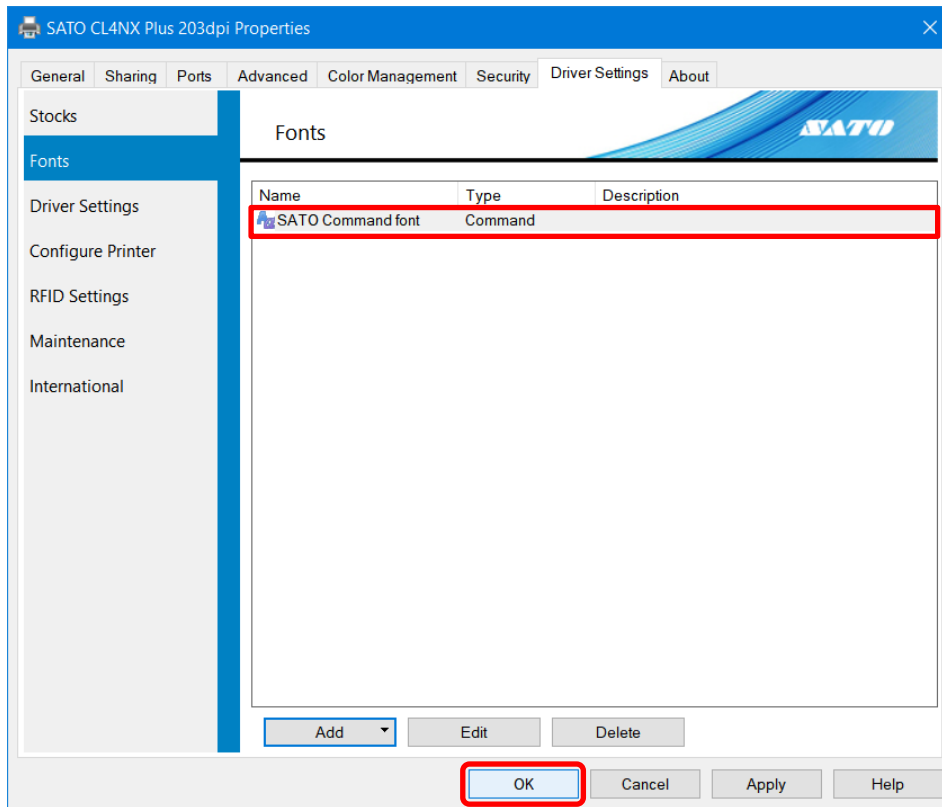

5. Start the application and specify the product that you set the command font for as the printer to be used.

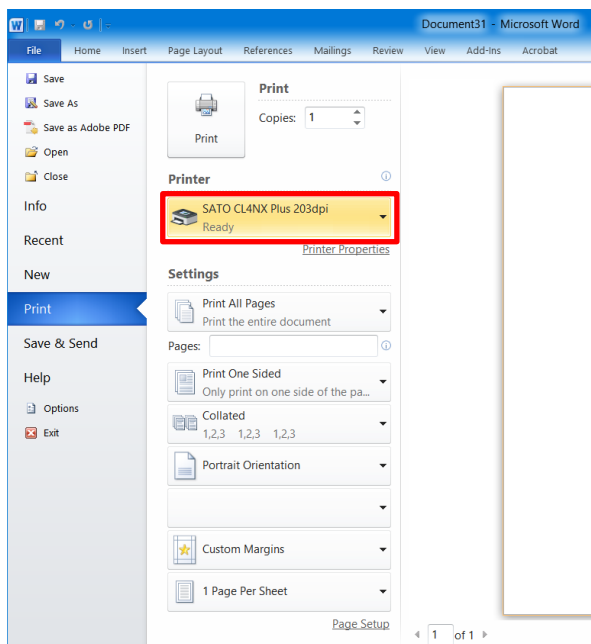

3.2.3 Substitution Font Settings and Usage Example

You can print by replacing the Windows system fonts with the device fonts of the product when defining substitution fonts.

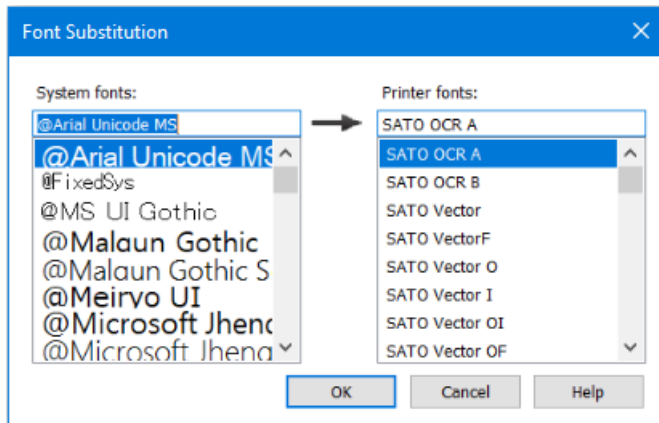

Use these fonts when you cannot select device fonts (they are not shown) from the application font list.

You can also replace them with the barcode and command fonts that you added.

Substitution Font Usage Example

This section describes an example using substitution fonts.

1. Open [Devices and Printers], right-click the printer driver, and select [Printer properties].
2. Display the [Driver Settings] tab, select [Fonts], then select [Add] > [Substitution].

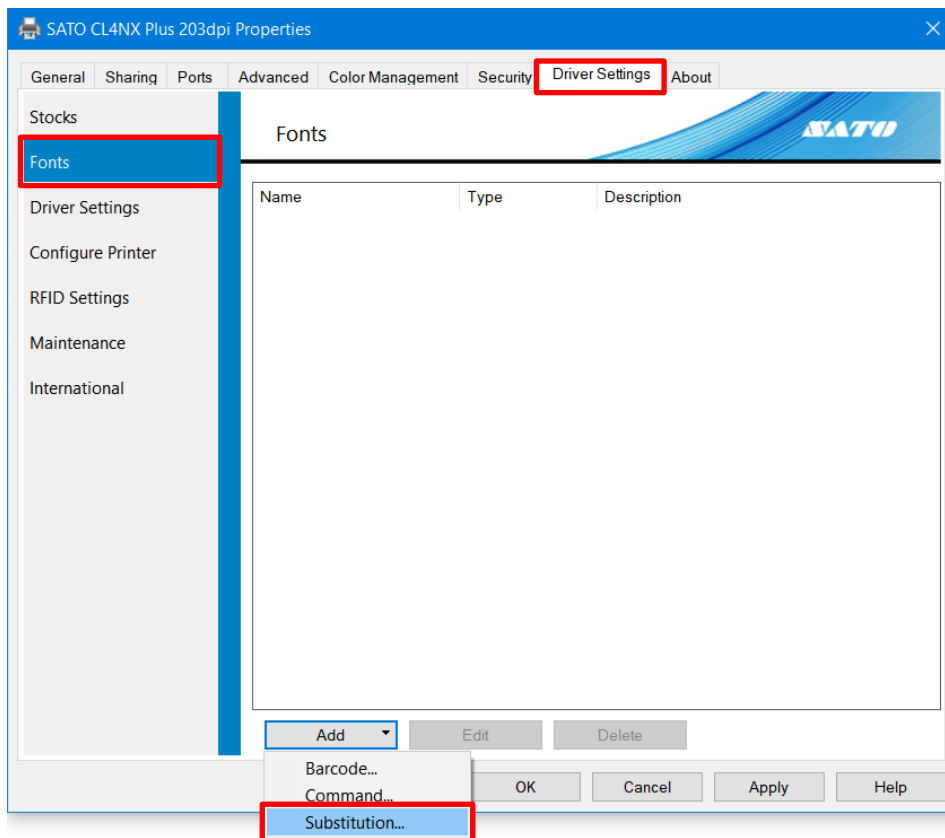

3. Configure the following settings and click [OK]:
Windows system fonts are shown in the [System fonts] field and device fonts of the product are shown in the [Printer fonts] field.

[System fonts]: [Agency FB]

[Printer fonts]: [SATO OCR A]

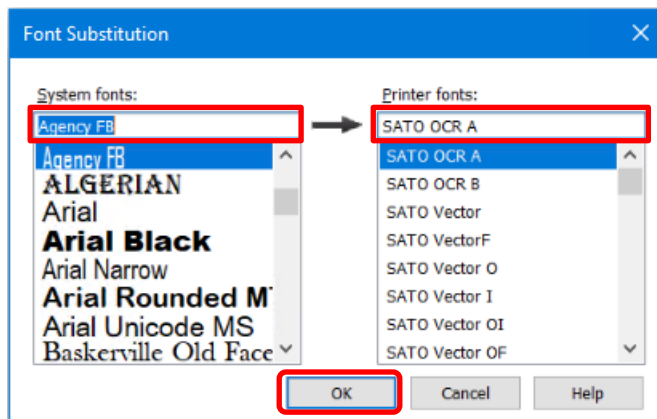

4. Confirm that the name you set for the substitution font is registered and click [OK].

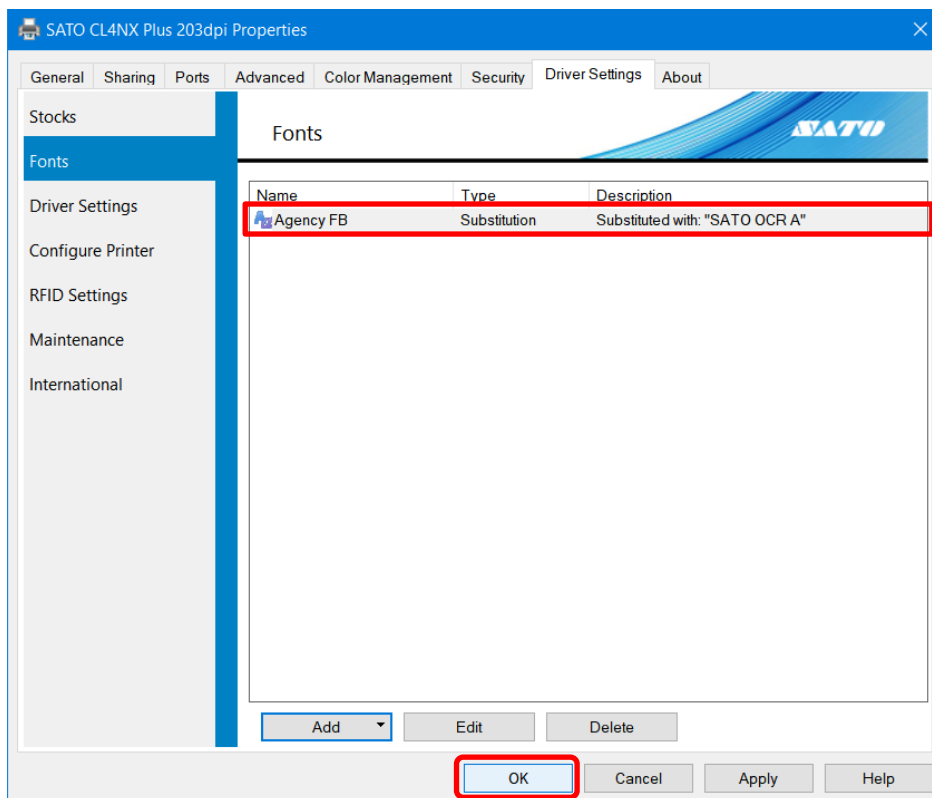

5. Start the application and specify the product that you set the substitution font for as the printer to be used.

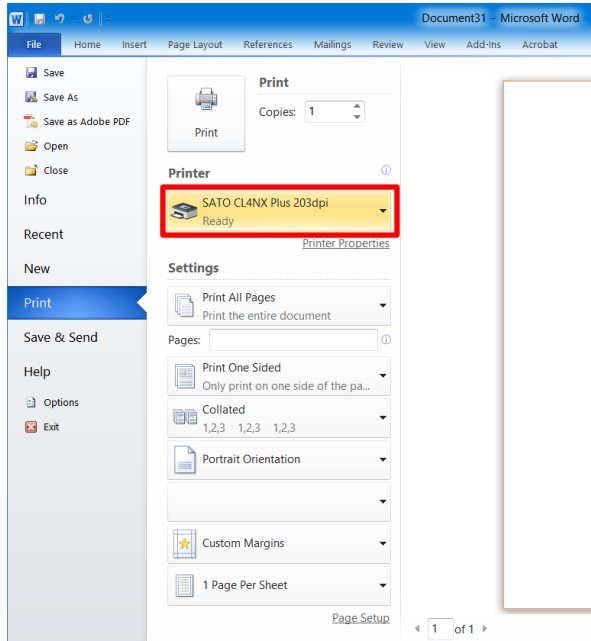

6. Enter text into the application and change the text font to the Windows system font that you set as the substitution font, "Agency FB".

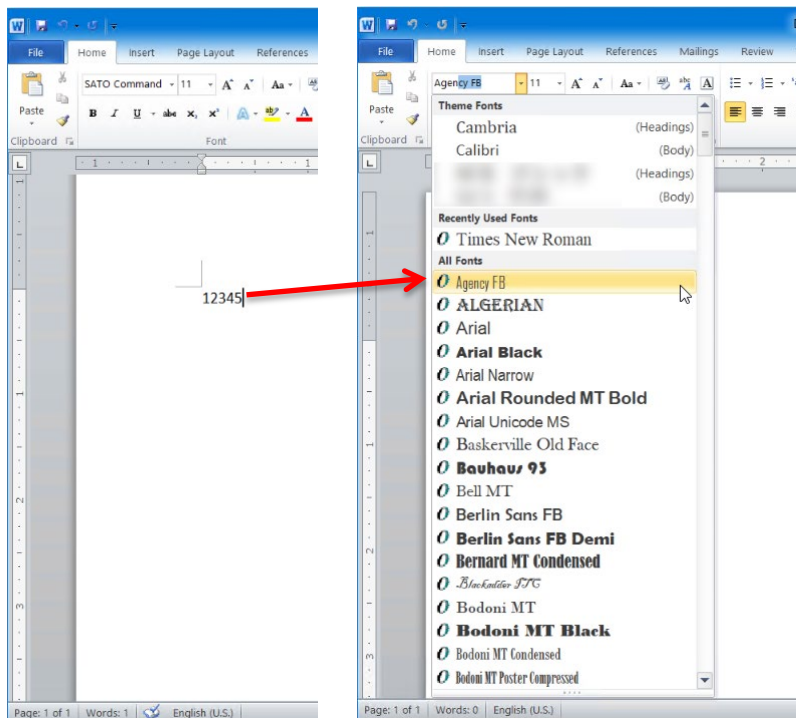

7. Print the text.

The font for "12345" is replaced by the substitution font that you set for the device font, "SATO OCR A," and printed.

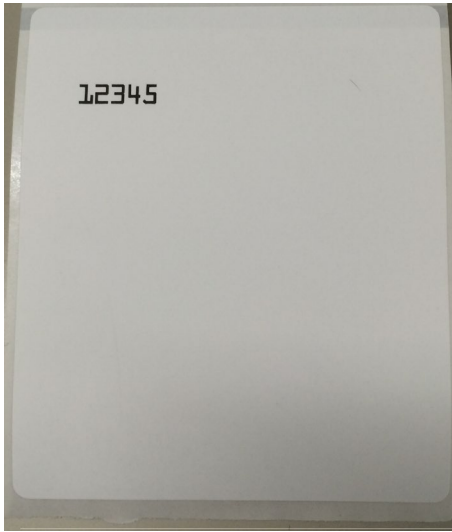

Note:

The text is not shown as the replaced device font on the edit or preview screens in applications.

3.3 Driver Settings

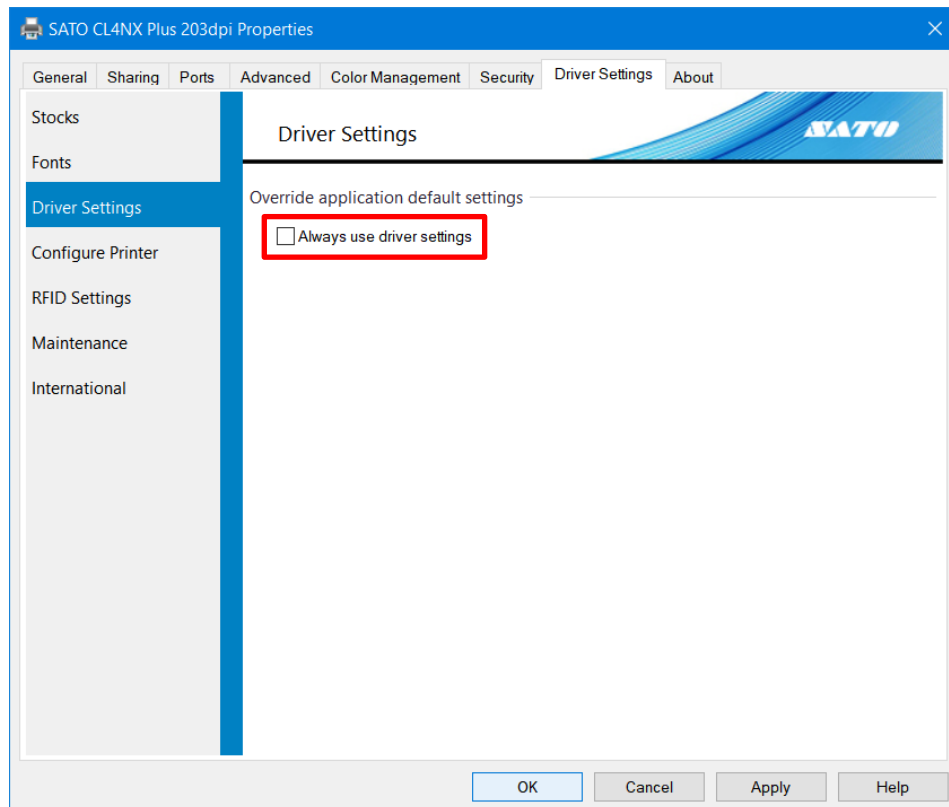

[Always use driver settings]

Enable this setting to discard all printer settings specified in the application and always use the settings on the printer driver.

Note that this setting cannot be used with some applications.

3.4 Configure Printer

You can acquire and change the settings of the product connected to the computer. To use this feature, the product needs to be available for printing from the computer using the printer driver. Note that the [Configure Printer] settings are not related to the printer driver settings.

1. Open [Devices and Printers], right-click the desired printer driver, and select [Printer properties].
2. Click [Get From Printer].

If you successfully acquire the settings from the product, the settings change to match those of the product settings.

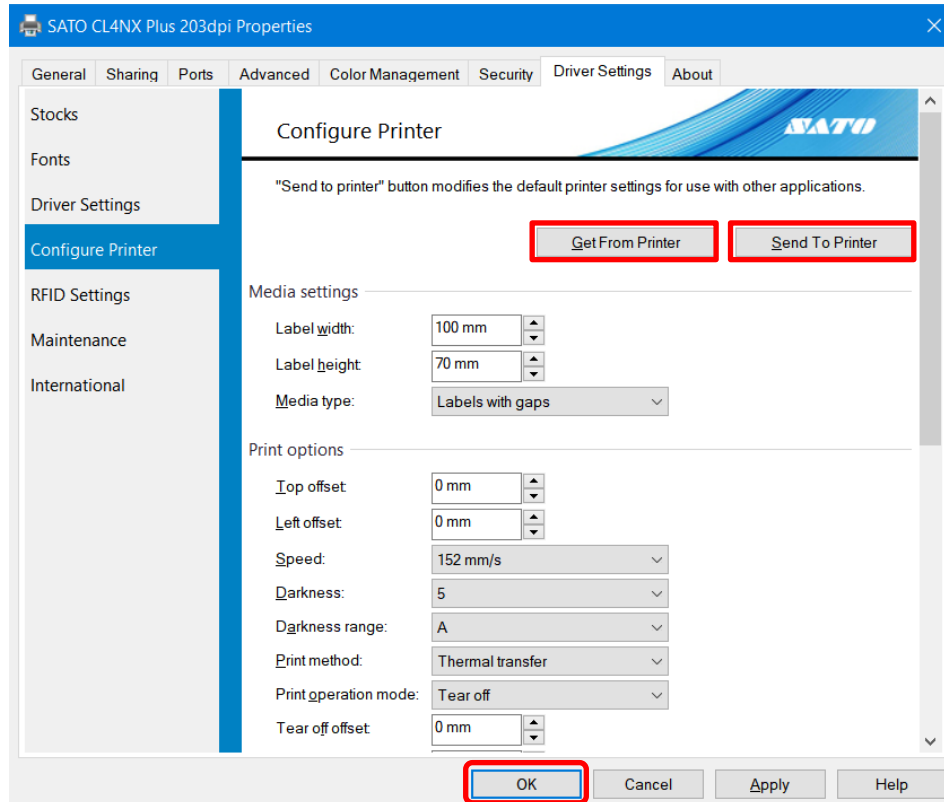

3. Change the settings as necessary.
4. Click [Send To Printer].
The settings are sent to the product. You can click [Get From Printer] again to confirm that the settings have been applied to the product.
5. Click [OK].
The screen closes.

3.5 RFID Settings

This screen allows you to acquire and change the RFID settings of the product if the optional RFID kit is installed. To use this feature, the product needs to be available for printing from the computer using the printer driver.

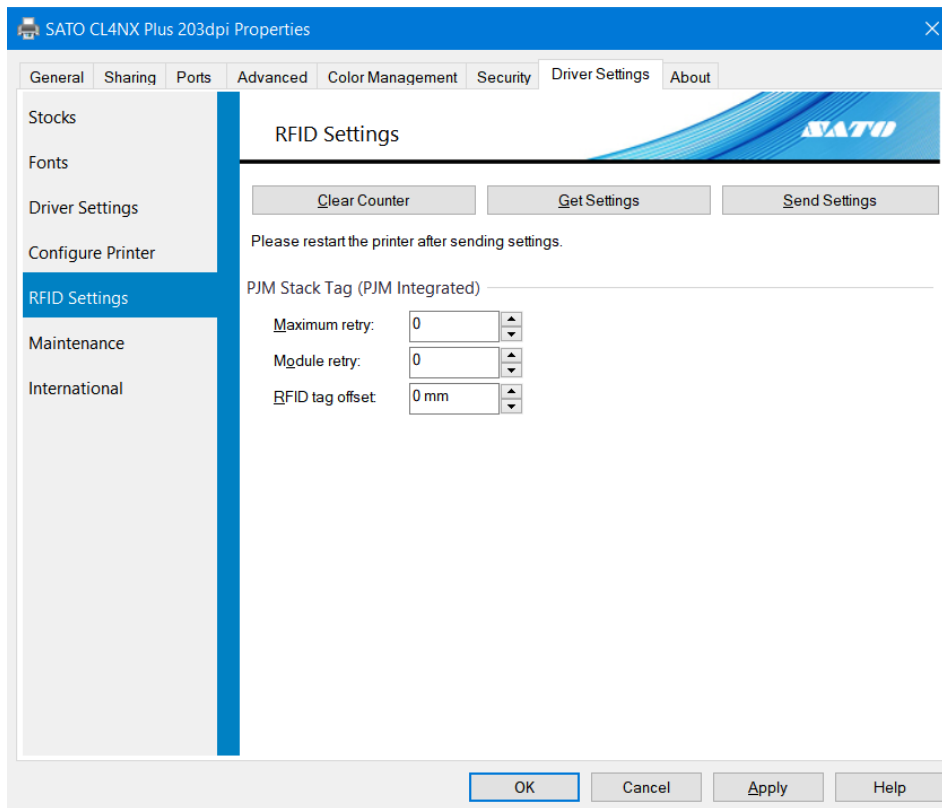

[Clear Counter]

Click to reset the RFID counters of the product.

[Get Settings]

Click to download the current RFID settings of the product.

[Send Settings]

Click to upload RFID settings to another compatible product.

Note:

You need to restart the product after sending settings.

PJM Stack Tag (PJM Integrated)

This group of settings lets you determine the PJM (Phase Jitter Modulation) RFID tag properties.

[Maximum retry]

Set the maximum number of failed encoding and printing attempts before error warning or pause.

The setting range is from 0 to 9. If you set to 0, the RFID error screen appears and printing continues.

[Module retry]

Set the maximum number of writing the data to the RFID module in case of an error.

The setting range is from 0 to 9.

[RFID Tag Offset]

Set the distance to print on label BEFORE pausing to encode RFID according to the Inlay Configuration Guide.

The setting range is from 0 to 240 mm.

This setting will be used when labels are not compatible with the CL4NX Plus's RFID antenna positions. For more information about compatible antenna positions, refer to "CL4NX Plus Operator Manual."

3.6 Maintenance

You can export or import printer driver settings to or from a file.

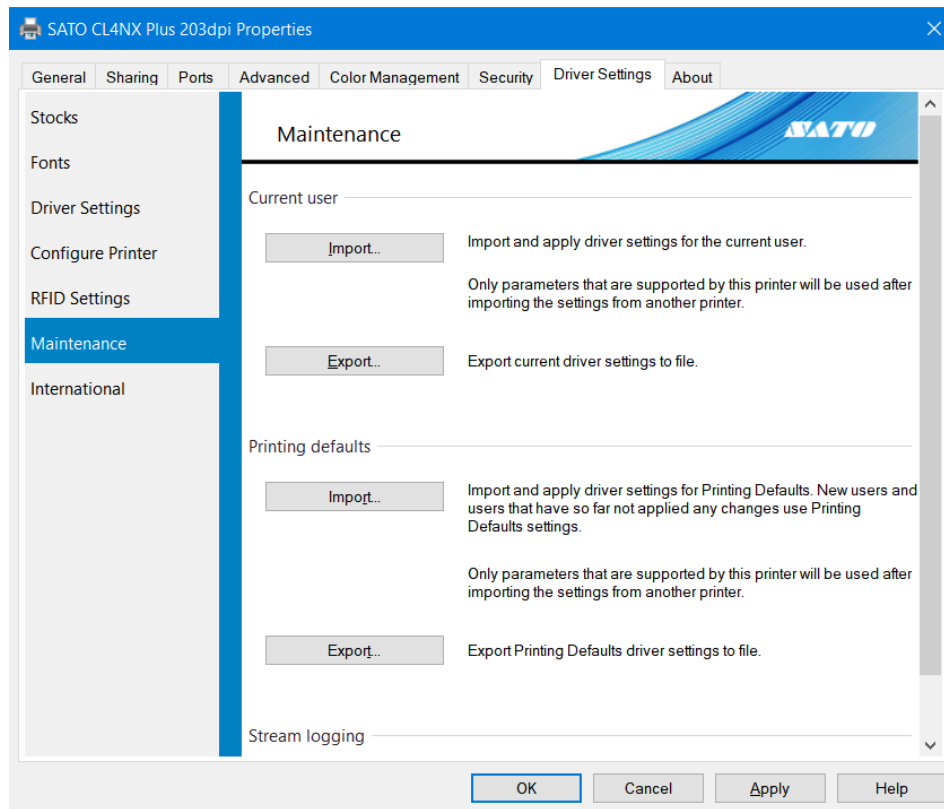

Current user

Export or import printer driver settings for an individual user.

[Import]

Load an exported settings file.

- The content of the imported file will be applied to the [Printing Preferences] and [Driver Settings] tabs for accounts with administrator privileges.
- For accounts that do not have administrator privileges, the content of the imported file will only be applied to the [Printing Preferences] tab.

[Export]

The settings on the [Printing Preferences] and [Driver Settings] tabs will be saved to a file. The file extension is ".drx".

Printing defaults

Export or import printer driver settings for all users.

[Import]

Load an exported settings file.

- The content of the imported file will be applied to the [Printing Defaults] and [Driver Settings] tabs for accounts with administrator privileges.
- This feature is not available for accounts that do not have administrator privileges.

[Export]

The settings on the [Printing Defaults] and [Driver Settings] tabs will be saved to a file.

The file extension is ".drx".

Stream logging

This feature is used by SATO Technical Support. Do not select the [Enable] check box.

Note:

- For details on [Printing Preferences] and [Printing Defaults], refer to "2.1 [Printing Defaults] (For All Users) and [Printing Preferences] (For Individual Users)."
 - Of the settings on the [Driver Settings] tab, the settings in [Configure Printer] cannot be imported or exported.
-

3.7 International

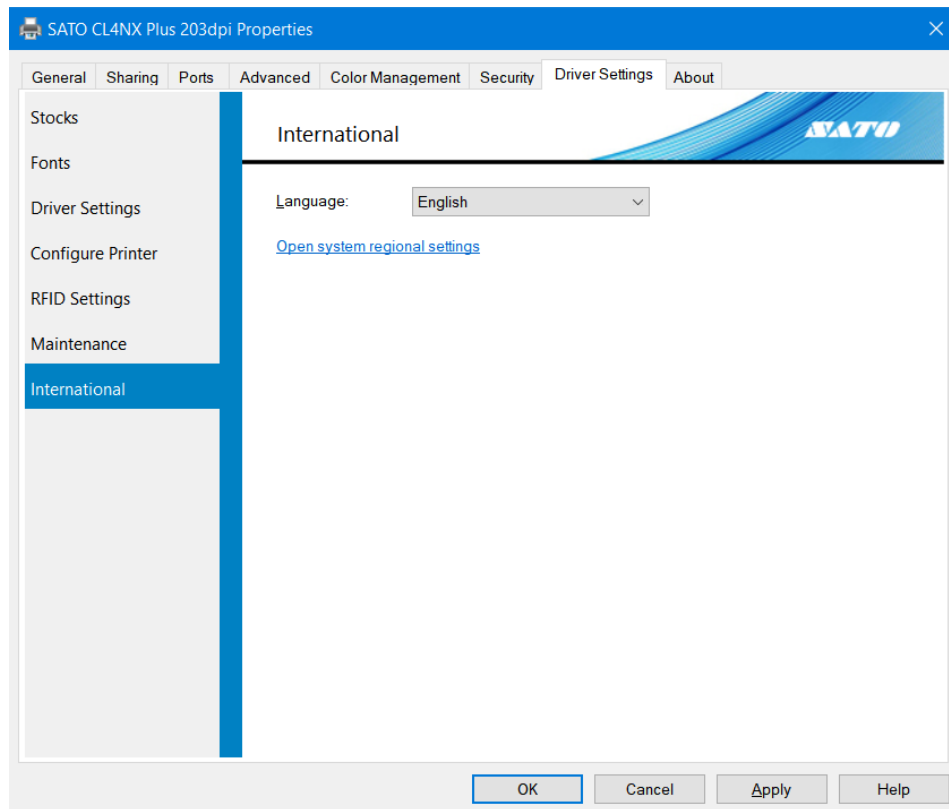

[Language]

Set the display language for the [Printing Defaults], [Printing Preferences], [Driver Settings], and [About] tabs.

4. Settings on the [Printer Settings] Tab

Product settings can be configured on [Printing Defaults] and [Printing Preferences]. As the settings that can be configured are the same on both screens, this section will use [Printing Preferences] (Printer Settings) tab to describe the settings.

[Help] is available on all screens. Click it to display a description of that screen.

Check Box Behavior

When a green or blue check box is to the right of a setting, they behave in the manner described below.

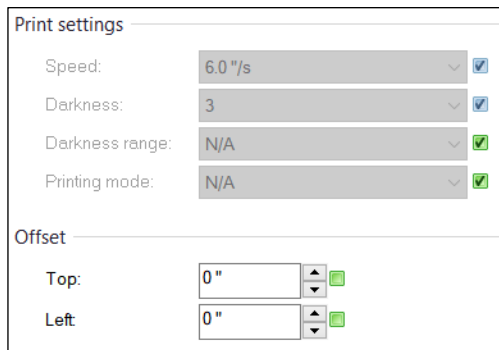

Green Check Box

Selected: [Let printer control this option]

"N/A" will be shown for the value of the setting. This setting value is not sent to the product and the product setting value is used. "N/A" will also be shown for other settings that must be used in combination with this setting.

Cleared: [Send this parameter to printer]

The setting values are sent to the product.

Blue Check Box

If you register stock in [Stocks] on the [Driver Settings] tab, this check box will be shown on the right of the following items.

Media settings

[Width]

[Height]

Print settings

[Speed]

[Darkness]

If you select the stock to be used in [Stock] on [Page Setup], you can change the above setting values all at once. For details, refer to "4.1 Page Setup."

Blue check boxes are always on and cannot be cleared. However, if you select [Let printer control this option], the green check box is selected for using the setting values on the product.

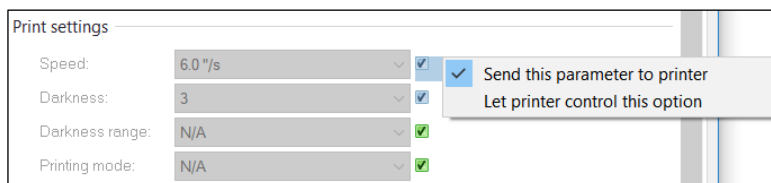

4.1 Page Setup

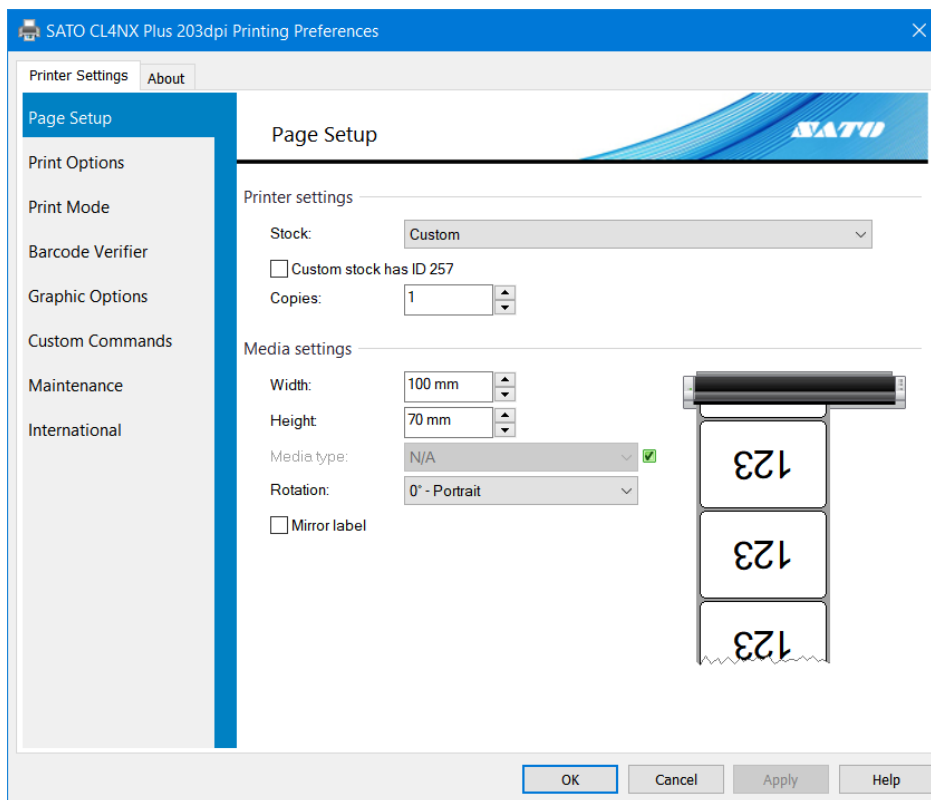

Printer settings

[Stock]

Select the default stock from the registered stock. If you select [Custom], you can set [Width], [Height], and [Sensors] on this screen.

[Custom stock has ID 257]

This check box enables compatibility with older SATO printer drivers that require a custom stock ID of greater than 256.

[Copies]

Specify the number of labels to be issued.

Media settings

[Width]

This setting shows the width set for the stock that you selected. If you select [Custom] for [Stock], you can change the settings on this screen.

[Height]

This setting shows the height set for the stock that you selected. If you select [Custom] for [Stock], you can change the settings on this screen.

[Media type]

This setting shows the sensor set for the stock that you selected. If you select [Custom] for [Stock], you can change the settings on this screen. You can select [Continuous labels], [Labels with gaps], or [Labels with black marks].

[Rotation]

You can set the print rotation angle as [0° - Portrait], [90° - Landscape], [180° - Portrait], or [270° - Landscape].

[Mirror label]

You can specify printing to be a mirror image.

4.2 Print Options

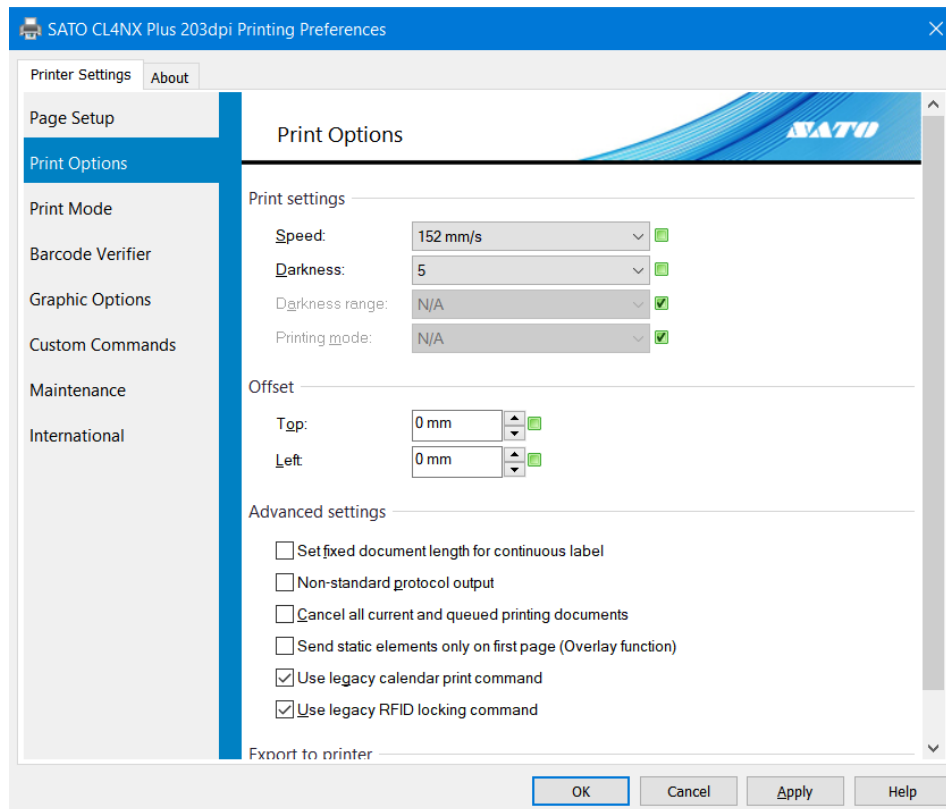

Print settings

[Speed]

This shows the print speed for the stock that you set on the [Page Setup] screen. If you select [Custom] for [Stock] on [Page Setup], you can change the settings on this screen.

[Darkness]

This shows the print darkness for the stock that you set on the [Page Setup] screen. If you select [Custom] for [Stock] on [Page Setup], you can change the settings on this screen.

You can set 10 levels, from [1] to [10]. The bigger the number, the darker the ink.

[Darkness range]

This shows the print darkness range for the stock that you set on the [Page Setup] screen. If you select [Custom] for [Stock] on [Page Setup], you can change the settings on this screen.

[Printing mode]

This shows the printing mode for the stock that you set on the [Page Setup] screen. If you select [Custom] for [Stock] on [Page Setup], you can change the settings on this screen.

You can set [Thermal transfer] or [Direct thermal].

Offset

[Top]

You can adjust the print base reference point in vertical direction (the height direction of the media).

[Left]

You can adjust the print base reference point in horizontal direction (the width direction of the media).

Advanced settings

[Set fixed document length for continuous label]

Feed the entire label to an appropriate position after the product finishes printing. For a continuous label, the one label is the feed amount because the feed amount cannot be determined by the sensor.

[Non-standard protocol output]

Substitute and output part of the control code as ASCII readable characters. This feature is for host environments that cannot use binary data.

[Cancel all current and queued printing documents]

Delete all jobs from the product buffer. Use this setting when you want to cancel the preceding jobs and print a new job immediately.

Caution

You cannot cancel this command. Take care when using it.

[Send static elements only on first page (Overlay function)]

All static elements will be sent to only the first page of the print job. Only variable elements will be sent for subsequent pages. Static elements are called from the product memory.

[Use legacy calendar print command]

Print the calendar by using the legacy <WA> command. If the option is unchecked, <WU> command is used instead.

[Use legacy RFID locking command]

Lock the RFID tag using the legacy "lck" command. If the option is unchecked, "lc2" command is used instead.

Export to printer

[Format number]

This setting is used when the XML-Enabled feature is used. For details, refer to "XML-Enabled Reference."

4.3 Print Mode

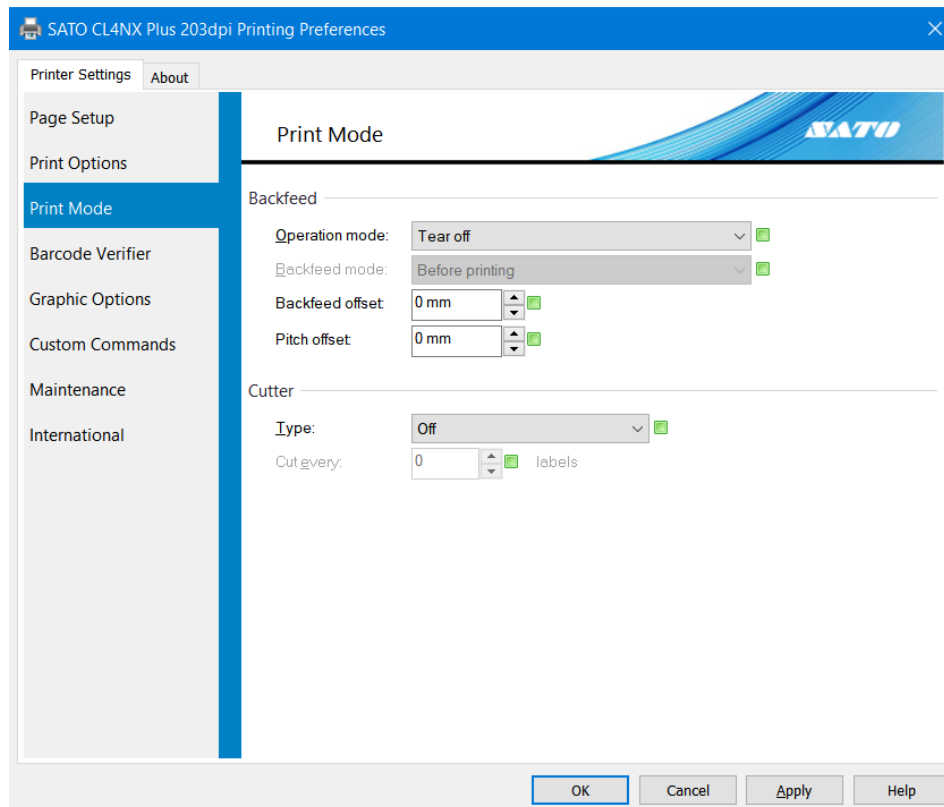

Backfeed

[Operation mode]

Set the print mode. The available settings vary depending on the product model and installed options.

[Backfeed mode]

Specify the backfeed operation for the [Operation mode] setting. You can configure this setting when [Operation mode] is set to [Cutter] or [Dispenser]. Select [No backfeed], [Before printing] or [After printing].

[Backfeed offset]

You can finely adjust the media stop position during backfeed operation.

[Pitch offset]

You can finely adjust the media stop position during forward feed operation.

Cutter

[Type]

Specify how the cutter operates when [Operation mode] is set to [Cutter]. Select [Off], [Batch], or [Every label]. If you select [Batch], the page is cut at the end of the print job.

[Cut every]

Specify the number of pages to cut at when [Type] is set to [Every label].

4.4 Barcode Verifier

When the optional barcode checker is installed to the product, the barcode checker scans the barcodes immediately after printing and checks the accuracy of printed 1D barcode and 2D code.

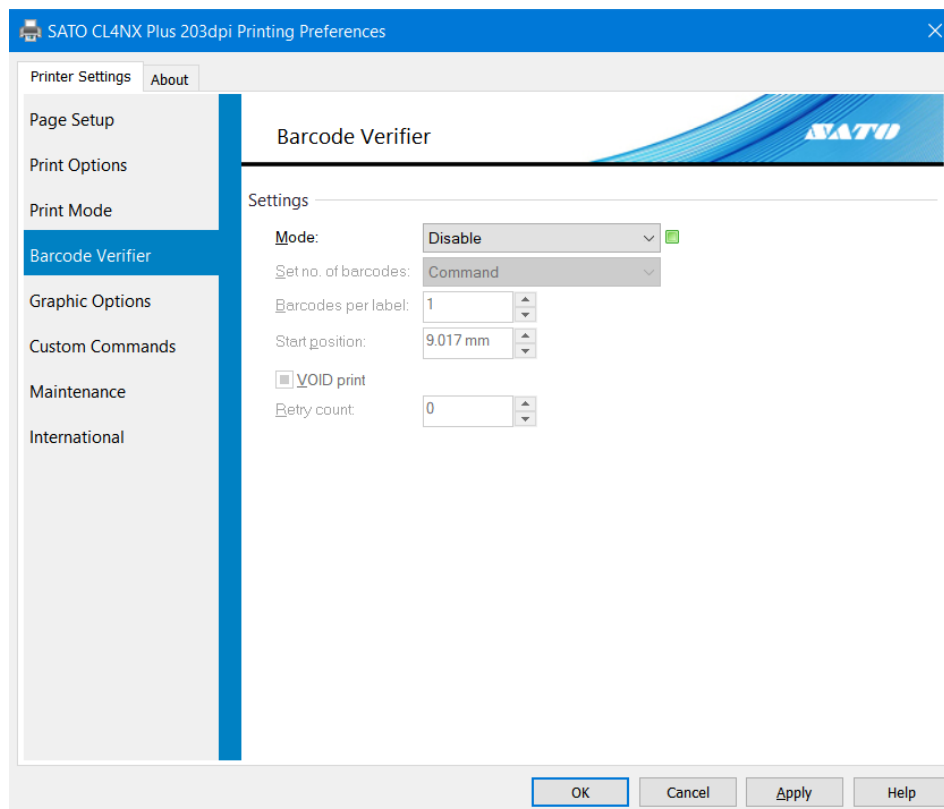

Settings

[Mode]

Set the Barcode Verifier mode of operation.

Select [Disable] to disable the Barcode Verifier. Select [Readable] to check for readability of barcodes. And select [Comparison] to check if the scanned results of the printed barcodes match the barcode print data.

[Set no. of barcodes]

Specify how to set the maximum number of verified barcodes.

Select [Command] to set the maximum number using direct command to the barcode checker. Select [Setting] to set the maximum number using printer driver interface.

[Barcodes per label]

Set the maximum number of verified barcodes per single printed label. The number is limited to 10.

[Start position]

Adjust the position at which the barcode checker starts to scan. It starts reading each media after the specified length passes from the printing start position. This setting can be used to exclude first barcode(s) from the check target when multiple barcodes are printed on each media.

[VOID print]

This check box enables printing of error marks on the media if a barcode reading error or barcode comparison error occurs.

[Retry count]

Set how many times the product will try to print and check the same barcode after VOID printing if a barcode reading error or barcode comparison error occurs.

4.5 Graphic Options

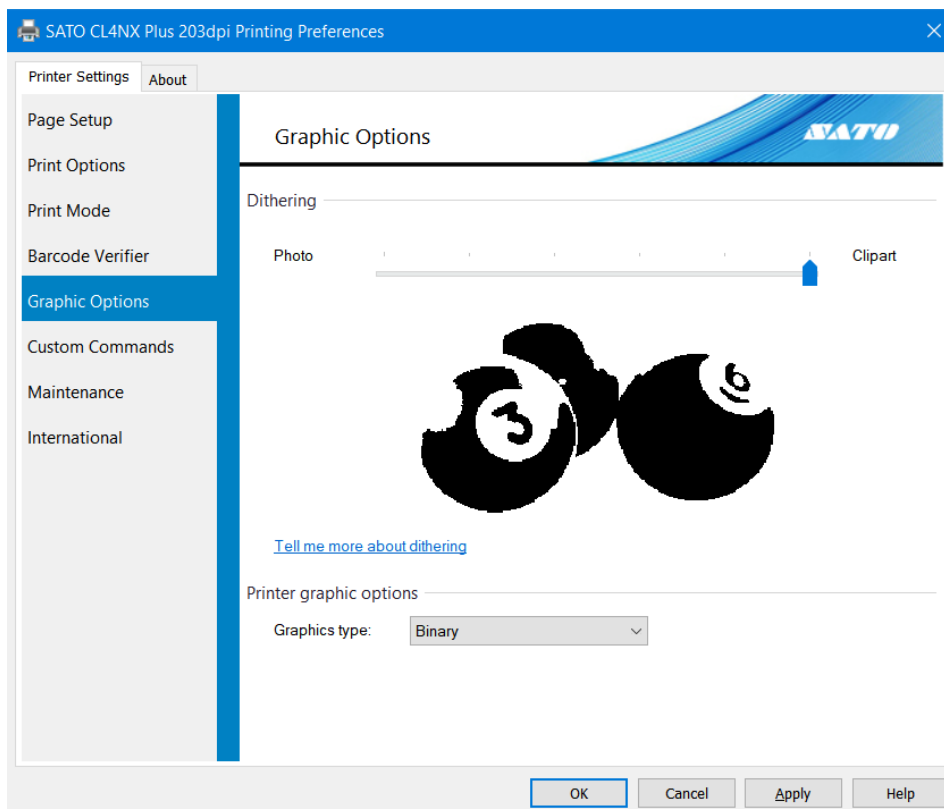

Dithering

Dithering is the process of expressing image gradation (for color or grayscale images) in the current image for thermal printers that can only express two colors, black and white, by juxtaposing pixels with a certain algorithm to create the illusion of half-tone. Select the dithering algorithm with this setting. You can view the result of applying the algorithm on the preview image. The size of the sent data will also change according to the setting. When considering the operational throughput, check the data size for each setting as well.

Printer graphic options

Specify the data format to send the graphics data to the product. Normally, specify [Binary].

4.6 Custom Commands

You can directly control the product by using custom commands. You can use features that are not directly supported by the printer driver. Knowledge of SATO Barcode Printer Language (SBPL) is necessary to use custom commands. For details on SBPL commands, refer to "CL4NX Plus Programming Reference."

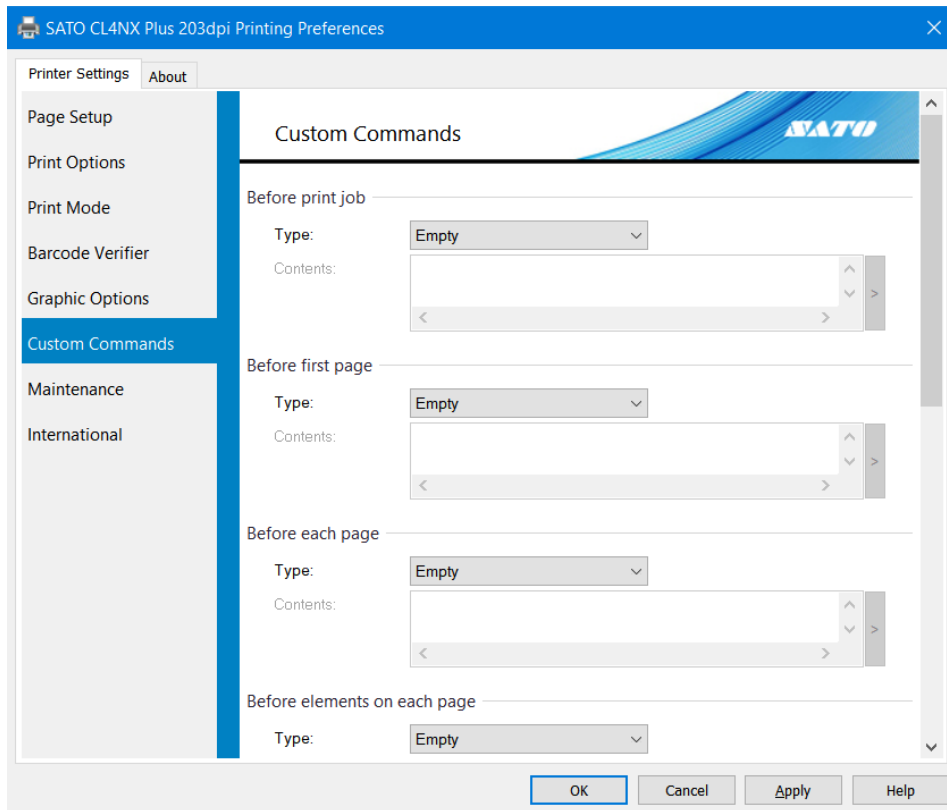

Custom command insert position

Before print job

Insert a command before a new print job. This setting affects all print jobs.

Before first page

Insert a command at the top of the first page in one file of data.

Before each page

Insert a command at the beginning of each page in one file of data.

Before elements on each page

Insert a command before an element on each page in one file of data.

After elements on each page

Insert a command after elements on each page in one file of data.

After each page

Insert a command at the end of each page in one file of data.

After last page

Insert a command at the end of the last page in one file of data.

After print job

Insert a command after the print job finishes.

Type

[Empty]

Do not use custom commands.

[File]

Load a custom command from the specified file.

[Text]

Enter the custom command directly into the [Contents] field.

[Parsed text]

Enter the custom command directly into the [Contents] field. You can enter control text as a substitute entry.

[Parsed file]

Load a custom command from the specified file. You can enter control text into the file as a substitute entry.

Note:

When printing a print layout created in an application (when outputting as a SBPL command), the custom command is inserted into each position according to the custom command insertion position setting in the printer driver.

The below figures show the print layout in an application and the custom command insertion position when the print settings are used.

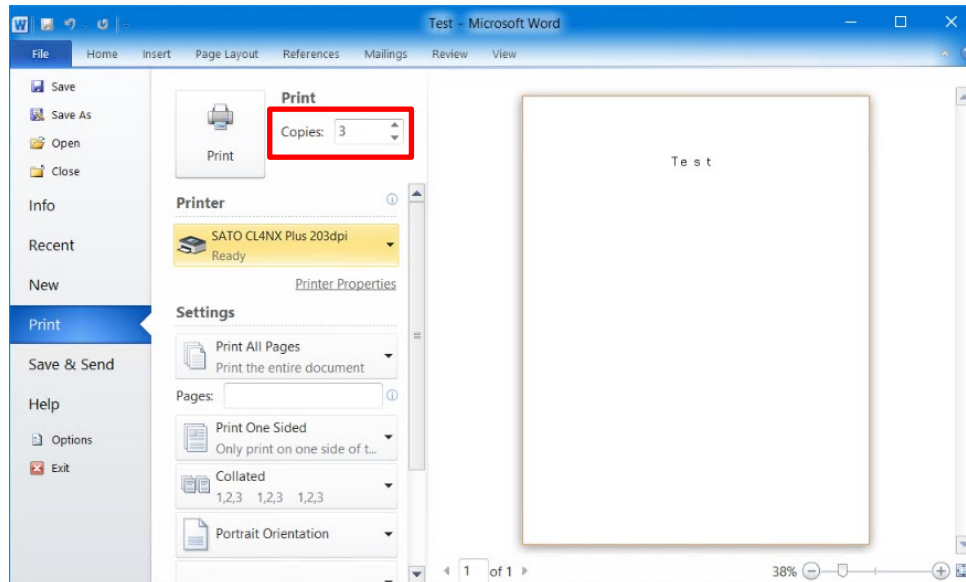

- "Test" in the print layout is set to "SATO X24" device font (the SBPL command is <X24>).
- The number of copies is set to [3].

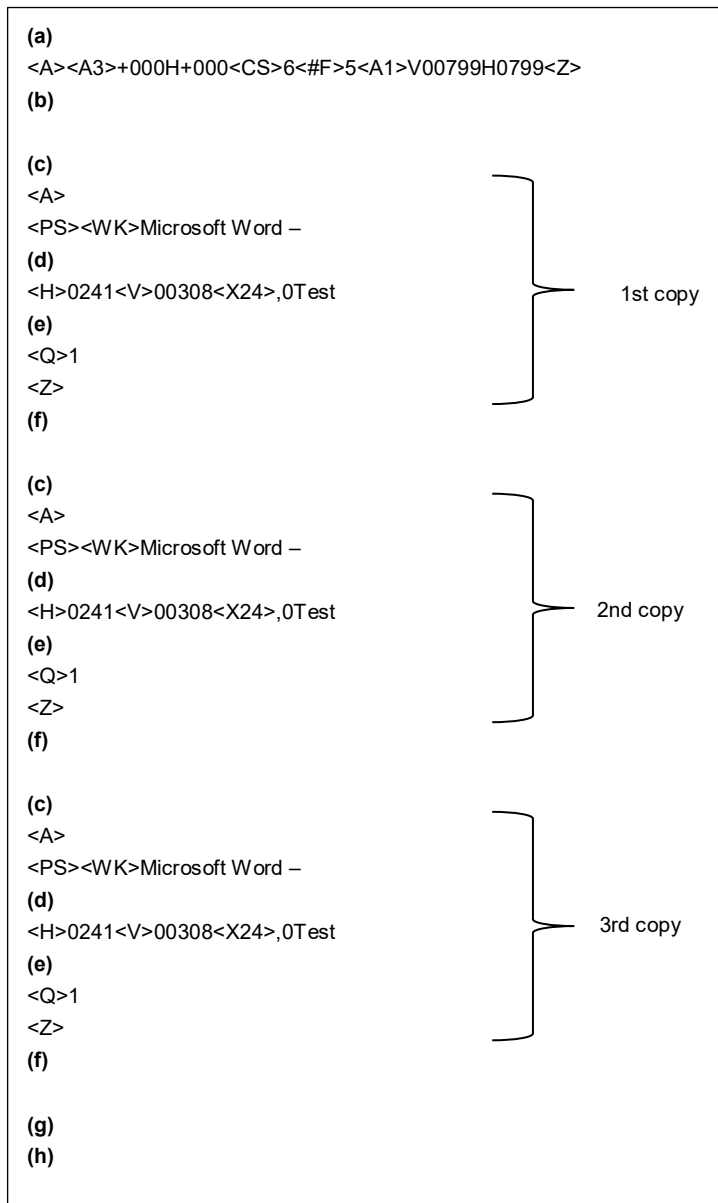

Symbols (a) through (h) in the figure correspond to the following custom command insertion position:

- (a) Before print job
- (b) Before first page
- (c) Before each page
- (d) Before elements on each page
- (e) After elements on each page
- (f) After each page
- (g) After last page
- (h) After print job

4.7 Maintenance

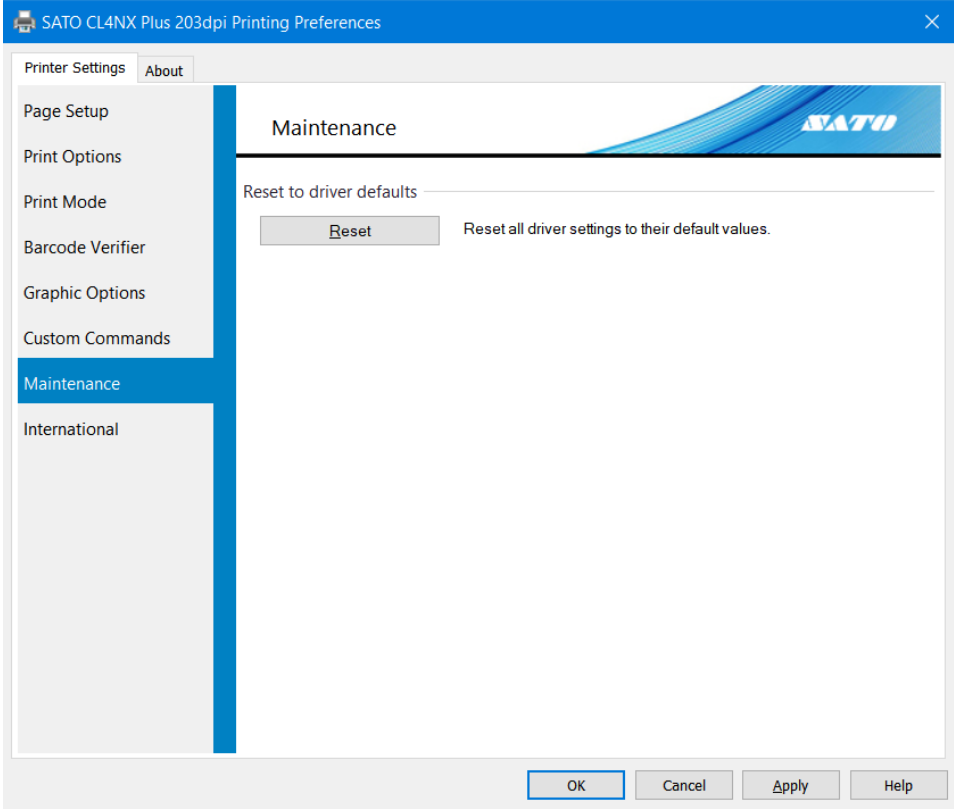

[Reset]

Return the printer driver settings to their default values.

4.8 International

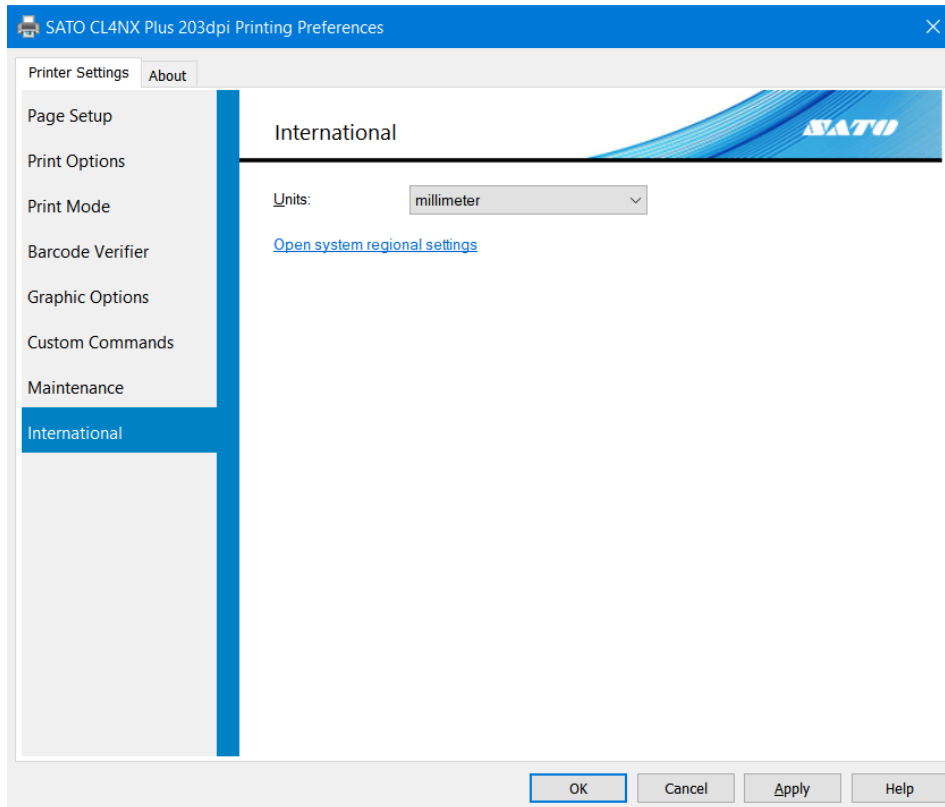

[Units]

Select the units to be used for the printer driver settings.

5. Sharing the Product

You can share a product connected directly to a computer on the network with other computers.

Connecting When Using the Printer Driver with Sharing Settings

The figure below shows how to connect when using the printer driver with sharing settings.

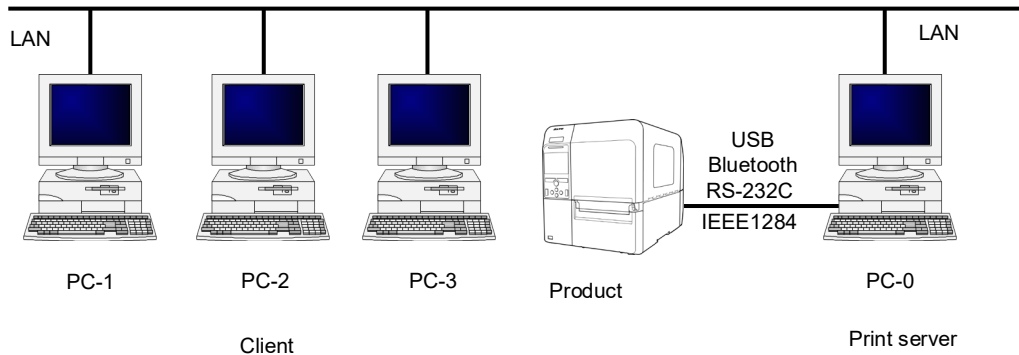

Set one computer (PC-0) as the print server and set other computers (PC-1, PC-2, PC-3 etc.) as clients. All computers should be connected using LAN connection and the print server and product should be connected via USB, Bluetooth, RS-232C or IEEE1284.

Procedure to Configure Printer Driver Sharing Settings

To use the printer driver with sharing settings, follow the steps below:

1. Install the printer driver on the print server and client computers.
Refer to "5.1 Installing the Printer Driver on the Print Server and Client Computers."
2. Confirm that a label can be output correctly from the product connected to the print server.
3. Configure the sharing settings on the product connected to the print server.
Refer to "5.2 Configuring Sharing Settings on the Print Server Printer."
4. Specify the product connected to the print server setup for sharing as the output destination port for the client printer and turn off bidirectional communication on the client printer.
Refer to "5.3 Configuring Sharing Settings on the Client Printer."

Restrictions

When you use the printer driver with sharing settings, the following restrictions occur because bidirectional communication is disabled on the client:

- Errors that occur on the product, such as "Paper End" and "Ribbon End", cannot be recognized.
- You cannot use [Get From Printer] and [Send To Printer] under [Configure Printer] on the [Printer Properties] > [Driver Settings] tab in the printer driver.
- The settings you change on the [Printing Preferences] > [Printer Settings] tab in the printer driver cannot be sent to the product (when the green check box is not selected).

5.1 Installing the Printer Driver on the Print Server and Client Computers

Download the printer driver from the SATO download site and install the printer driver on the print server and client computers. Install the printer driver on all applicable computers.

Downloading the Printer Driver

Download the printer driver from the SATO download site.
For details, refer to "1.1 Preparing the Printer Driver."

Installing the Printer Driver on the Print Server

Connect the product to the computer and install the printer driver.
For details on how to connect the product, refer to "1.2 Connecting the Product to the Computer."
Printer driver installation differs depending on how the product is connected. For details, refer to "1.3 Running the Installation."

Installing the Printer Driver on the Client Computers

Prepare the printer driver in the same manner as the print server and follow the procedure below to install the printer driver. The procedure uses Windows 10 as an example.

1. Double-click PrnInst.exe.
The printer installation wizard starts.
2. Click [Next].

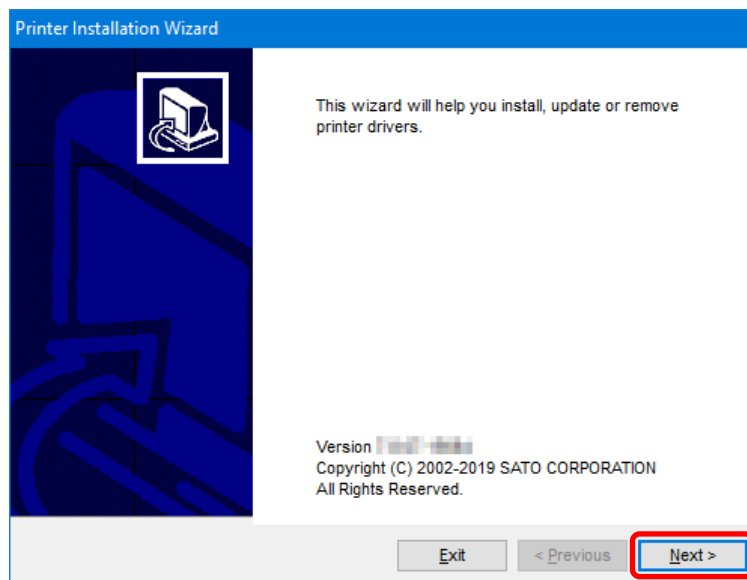

3. Click [Install Printer Driver].

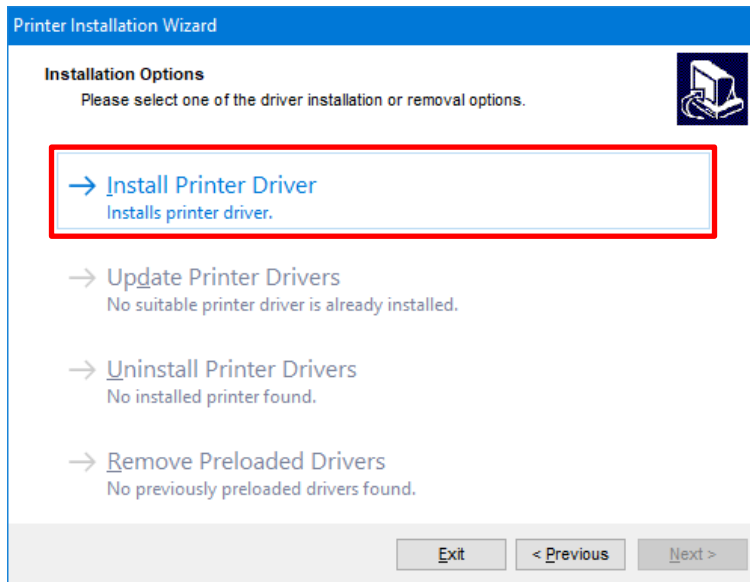

4. Click [Local Port].

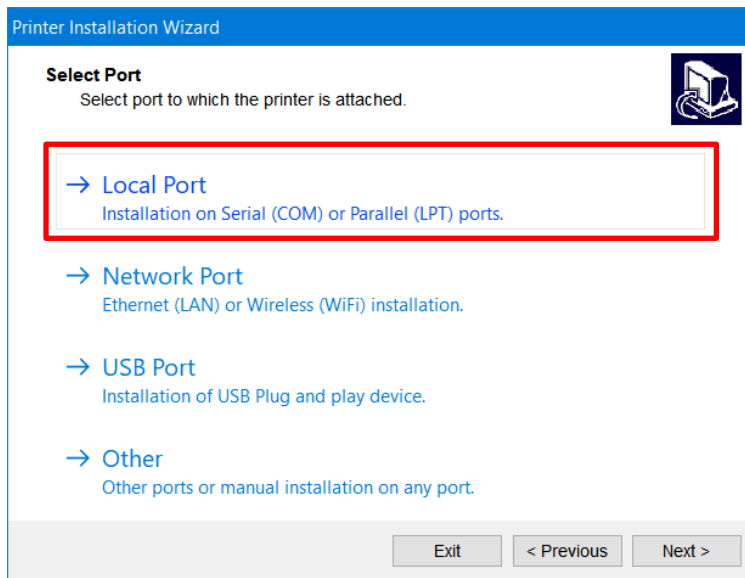

5. Select the model of the product and click [Next].

The following illustration shows SATO CL4NX PLUS 203dpi is selected as an example.

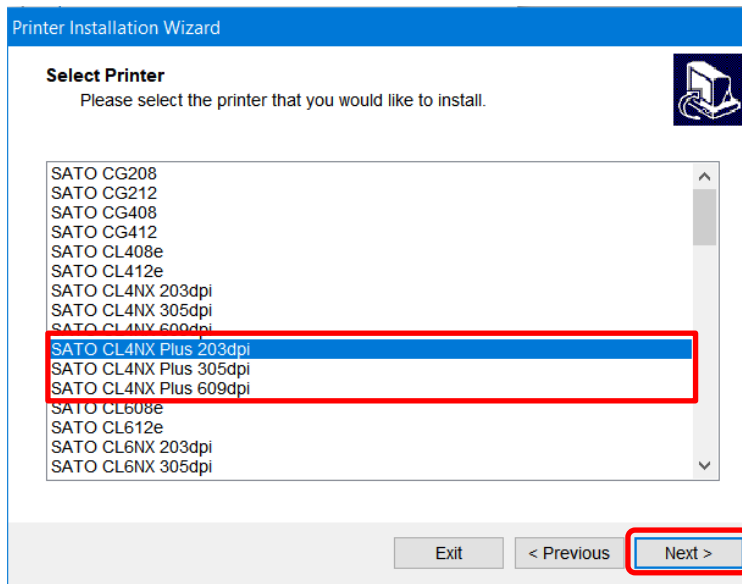

Note:

Select the model that is compatible with the resolution of the product. The resolution of the product is shown on the upper left of the Online/Offline screen.

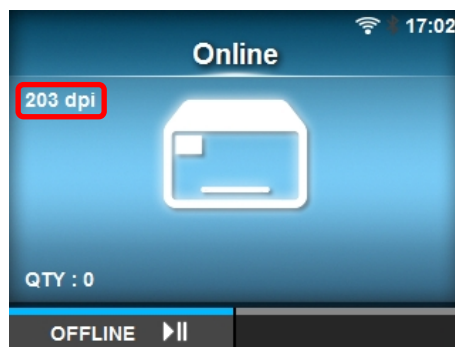

6. Select an LPT or COM port and click [Next].

The following illustration shows COM1 is selected as an example.

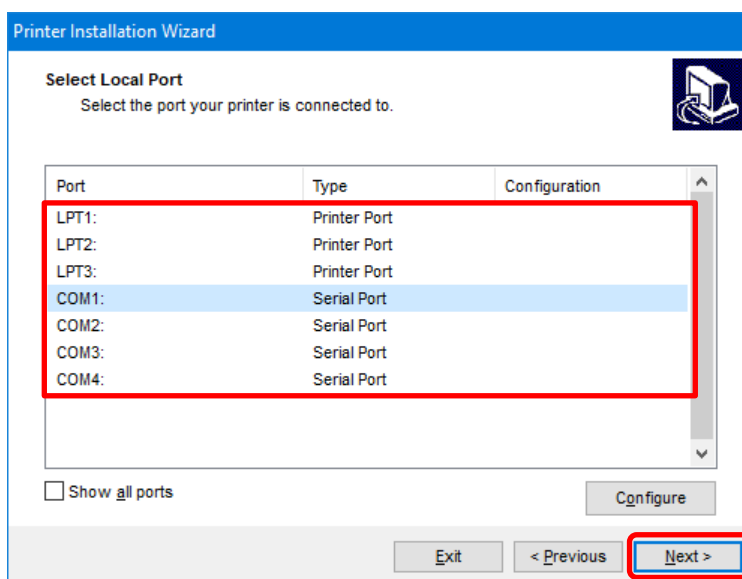

7. Click [Install].

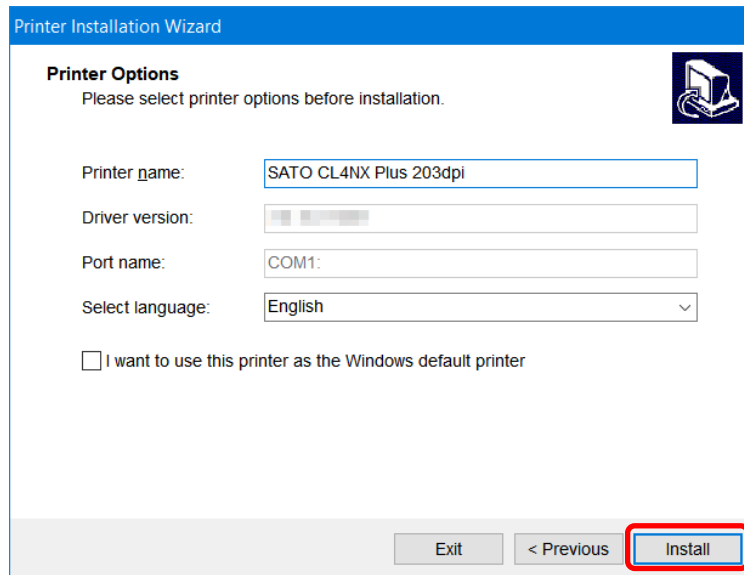

When the [Windows Security] screen appears, click [Install].

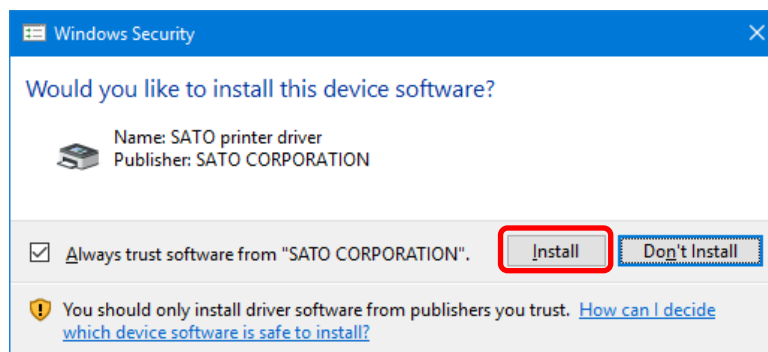

Note:

The warning screen above may not appear, depending on the version of the printer driver or your computer environment.

If a security warning screen indicating that another process is blocking access appears, follow the on-screen instructions.

8. Confirm that [succeeded] is shown for the installed printer driver and click [Exit].

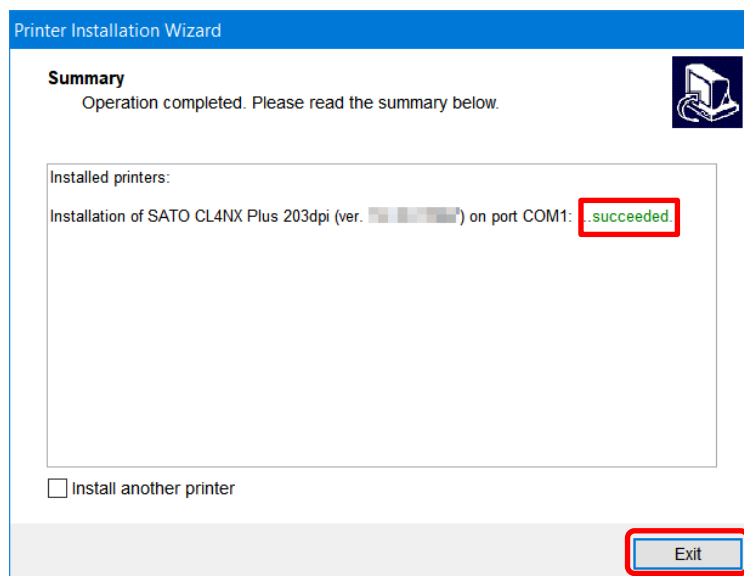

9. Open [Devices and Printers] and confirm that the printer driver has been added to the list of [Printers].

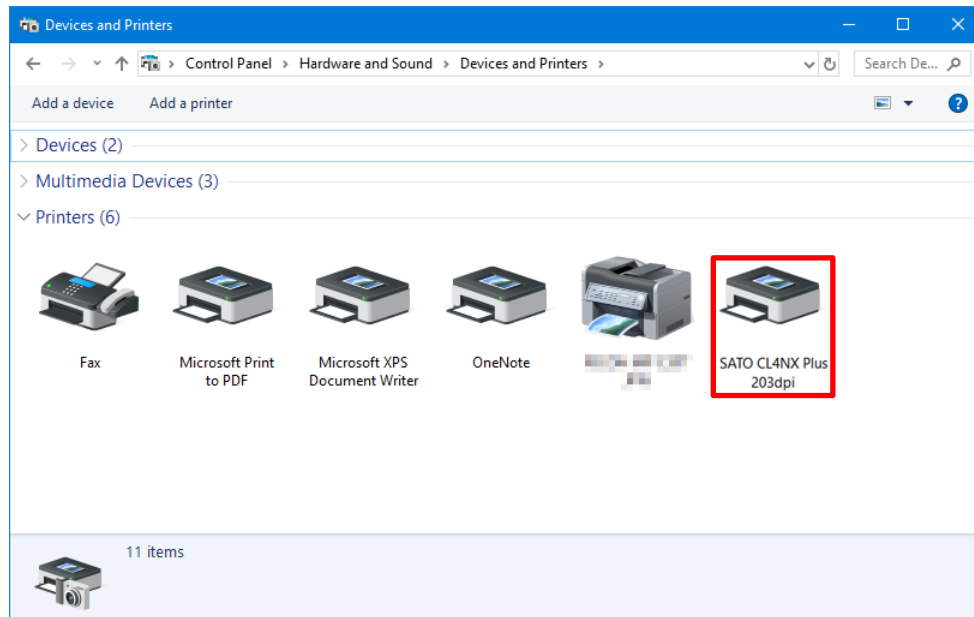

Install the printer driver on all client computers using the above procedure.

5.2 Configuring Sharing Settings on the Print Server Printer

Set the printer driver installed on the print server to enable it to be shared with other computers.

1. Open [Devices and Printers], right-click the installed printer driver, and select [Printer properties].

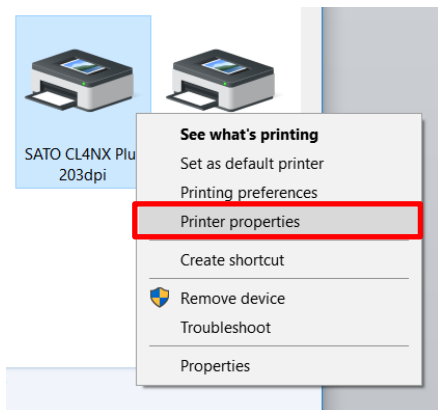

2. Select the [Sharing] tab.

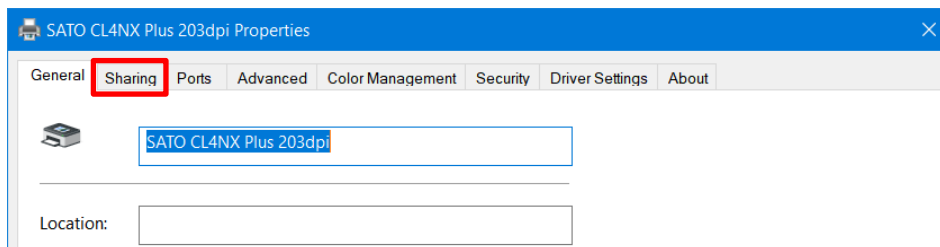

3. Select the [Share this printer] check box and click [OK].
If necessary, change [Share name].

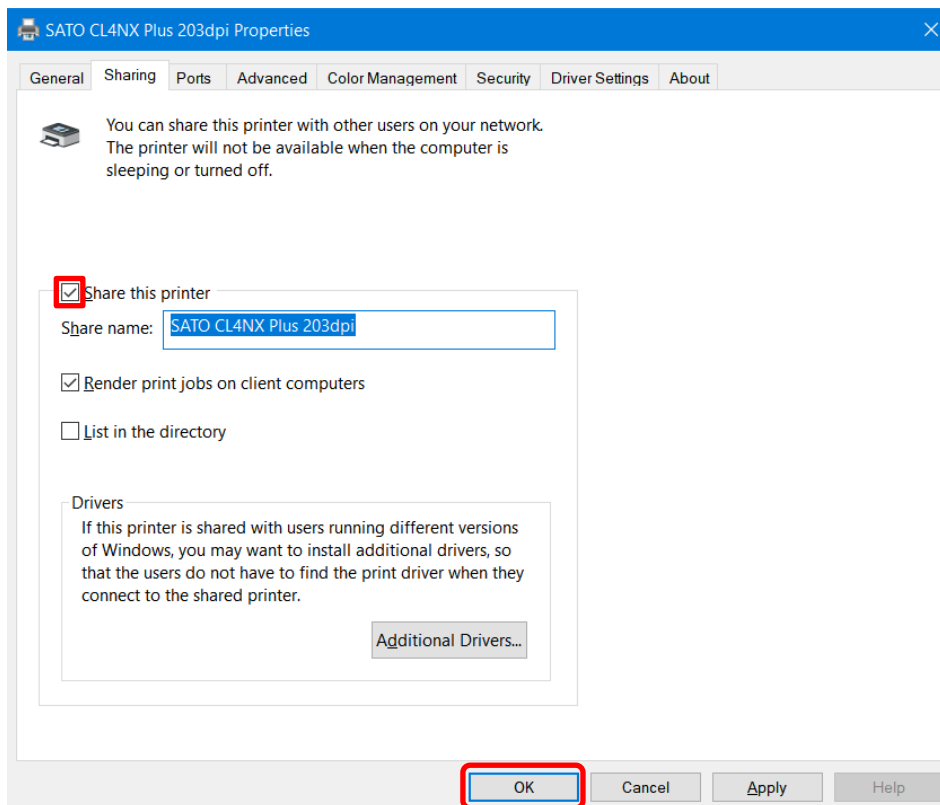

4. Open [Devices and Printers] and confirm that the printer sharing settings have been set.

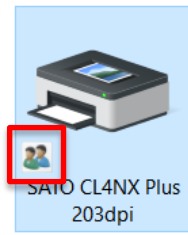

5.3 Configuring Sharing Settings on the Client Printer

Configure the sharing settings on the printer driver installed on the client.

1. Open [Devices and Printers], right-click the installed printer driver, and select [Printer properties].

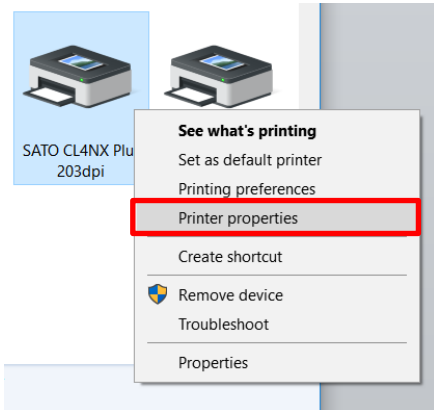

2. For accounts that do not have administrator privileges, click the [Sharing] tab and then [Change Sharing Options].

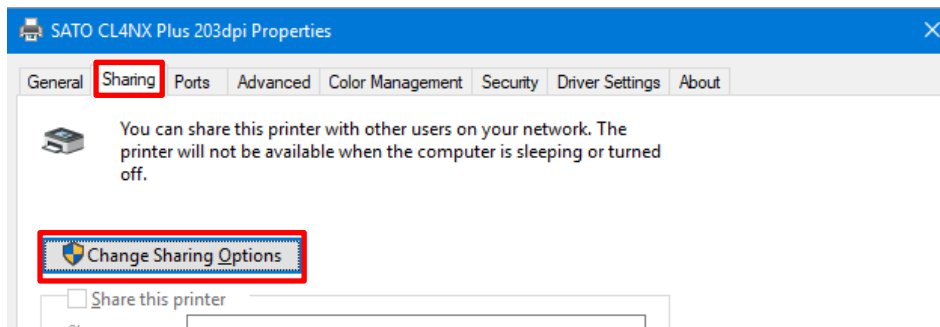

Follow the on-screen instructions.

3. Select the [Ports] tab.

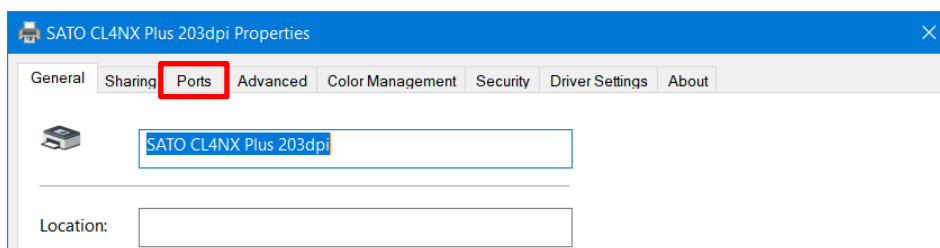

4. Click [Add Port].

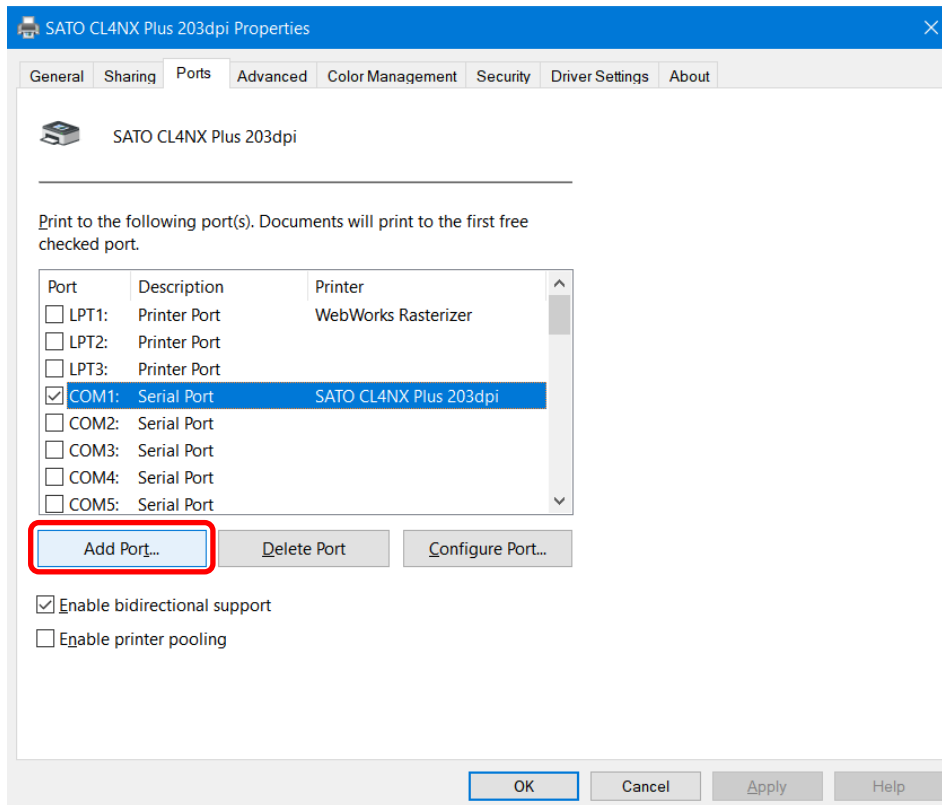

5. Select [Local Port] and then click [New Port].

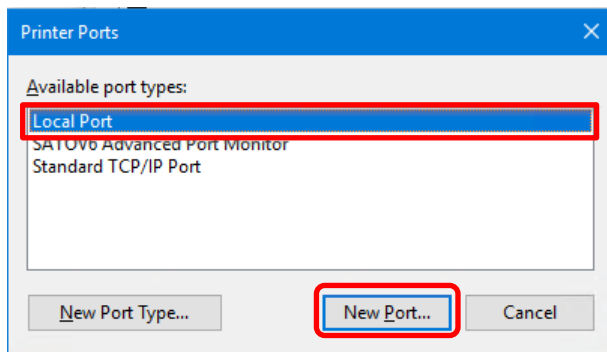

6. Into the port name field, enter "\\<Print_Server_Computer_Name>\<Printer_Sharing_Name>" and then click [OK].

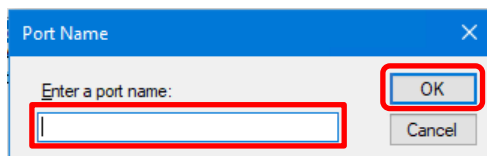

For example, if the print server computer name is "PC-0" and the printer sharing name is "SATO CL4NX Plus 203dpi", enter the following:

\\PC-0\SATO CL4NX Plus 203dpi

Note:

On Windows 10, you can check the computer name by clicking [Control Panel] > [All Control Panel Items] or [System and Security] > [System] > [Computer name].

7. Click [Close].

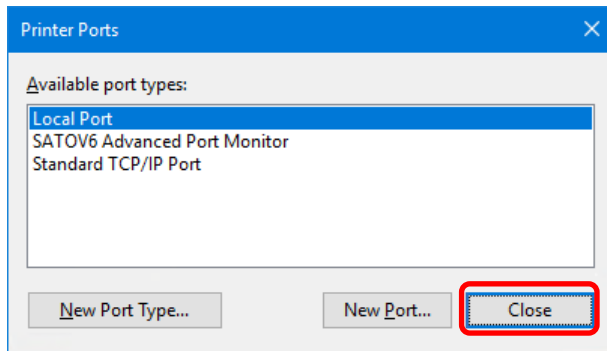

8. Clear the [Enable bidirectional support] check box and click [Close].

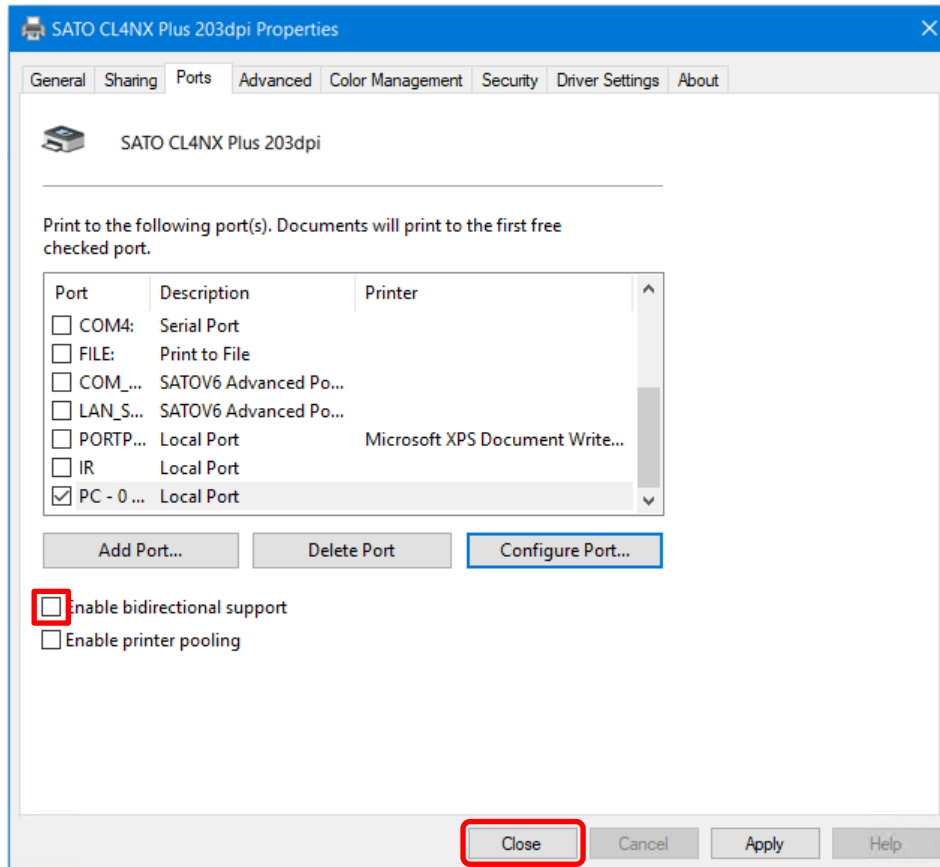

6. Updating the Printer Driver

Update the installed printer driver to the latest version.

Be sure to save the printer driver data before updating.

Save the printer driver data using [Maintenance] on the [Driver Settings] tab.

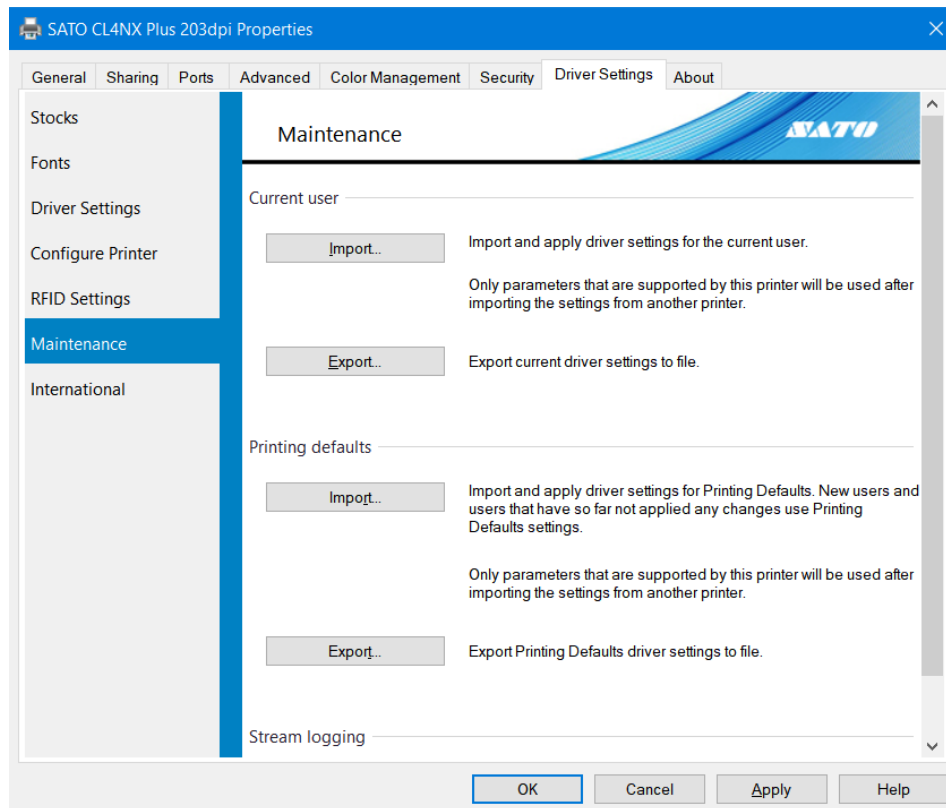

Saving the Current Printer Driver Data

1. Open [Devices and Printers], right-click the printer driver for which you want to update, and select [Printer properties].
2. Click the [Driver Settings] tab.
3. On [Maintenance], export the current printer driver settings.
For details on how to export the settings, refer to "3.6 Maintenance."

Obtaining the Printer Driver

Download the printer driver from the SATO download site.

For details on how to obtain the printer driver, refer to "1.1 Preparing the Printer Driver."

Updating the Printer Driver

1. Double-click PmInst.exe for the update version.
The printer installation wizard starts.
2. Click [Next].

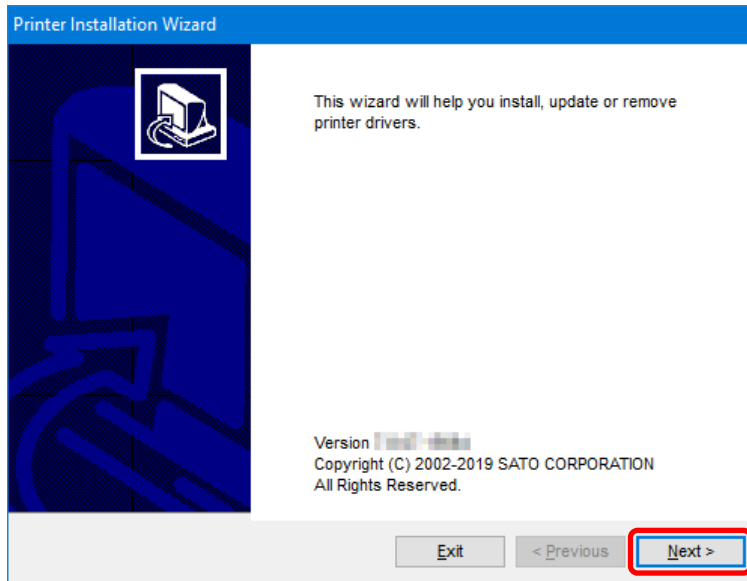

3. Click [Update Printer Drivers].

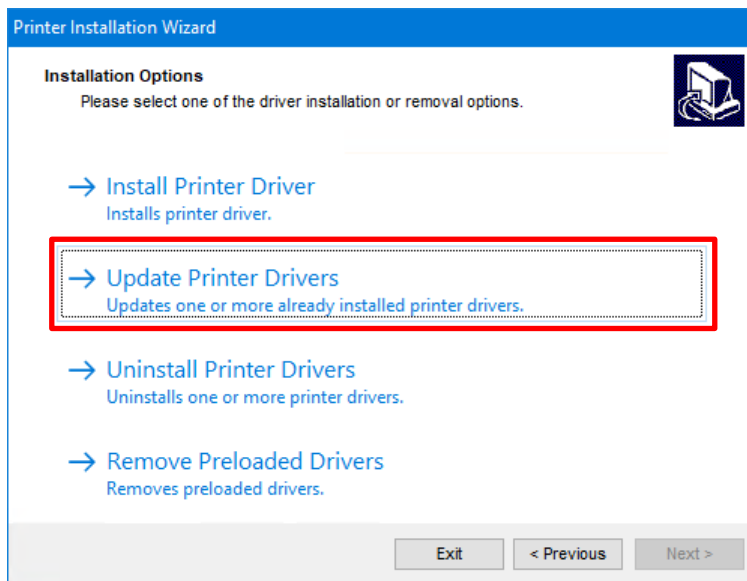

4. Select the check box of the printer driver that you want to update and click [Update].

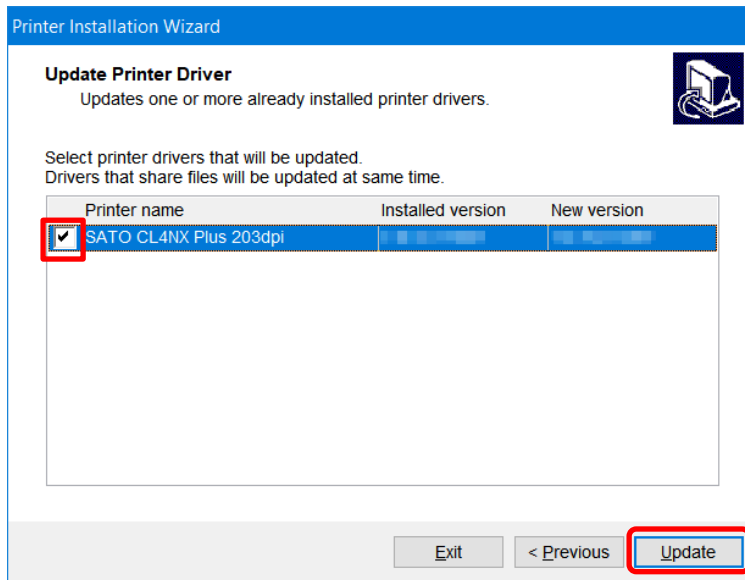

The printer drivers will start updating.

5. Confirm that [succeeded] is shown for the installed printer driver and click [Exit].

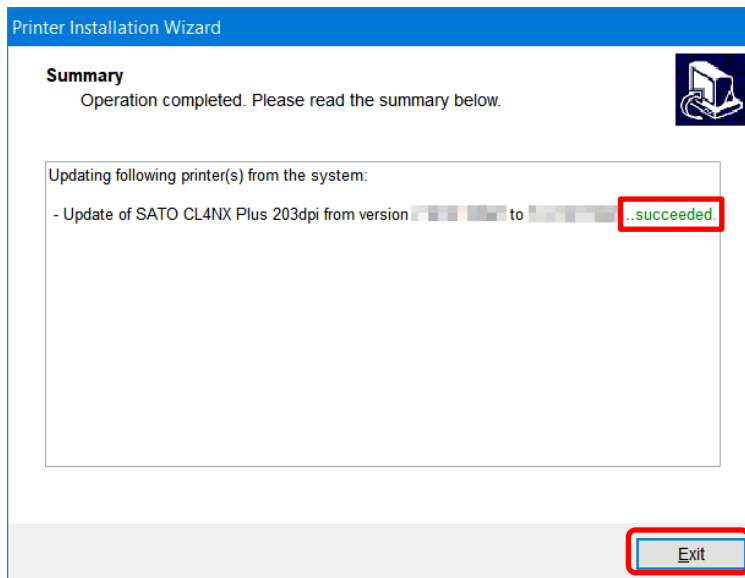

Importing an Exported File

1. Open [Devices and Printers], right-click the updated printer driver for which you have exported the printer driver data, and select [Printer properties].
2. Select the [Driver Settings] tab.
3. On [Maintenance], import the driver settings that you saved before updating the driver. For details on how to import settings, refer to "3.6 Maintenance."

7. Uninstalling the Printer Driver

The installer (PrnInst.exe) is also used to uninstall the printer driver.

Caution

Do not use [Remove device] in [Devices and Printers]. The printer driver may not be uninstalled correctly.

Pre-checks

Check the following items before uninstalling the printer driver.

Is the Installer (PrnInst.exe) on the Computer?

If PrnInst.exe is not on the computer, obtain it from the SATO download site.

For details, refer to "1.1 Preparing the Printer Driver."

Is the USB Cable Disconnected from the Computer?

When uninstalling the printer driver of a product connected to a computer via USB, power off the product and disconnect the USB cable connecting the product from the computer.

Uninstalling the Printer Driver

1. Double-click PrnInst.exe.
2. Click [Next].
3. Click [Uninstall Printer Drivers].

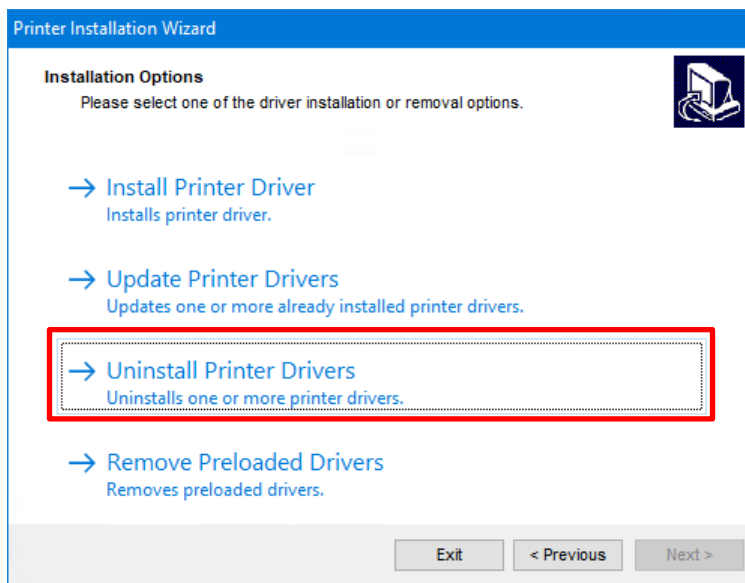

4. Select the check box of the printer driver that you want to uninstall and click [Next].

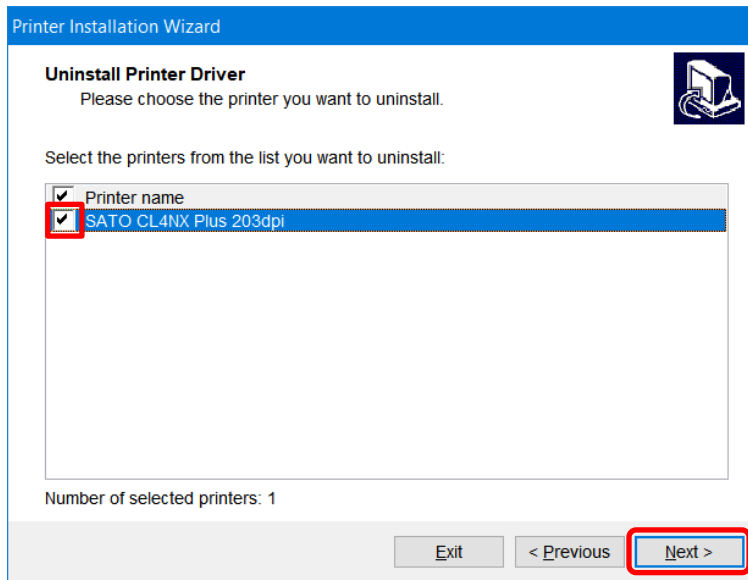

The uninstallation procedure starts.

5. Confirm that [succeeded] is shown for the uninstalled printer driver(s) and click [Exit].

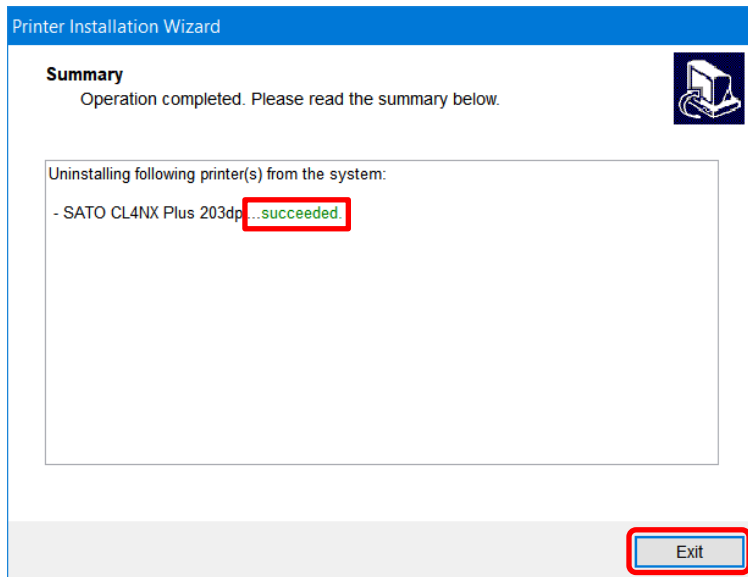

8. Removing the Printer Driver Data File

When the printer driver is installed, the printer driver data file is also installed. Even if you uninstall the printer driver, the printer driver data file remains on the computer. If the printer driver data file exists, you can install the printer driver with Plug and Play.

Once you have uninstalled all printer drivers and you do not intend to install the printer driver with Plug and Play in the future, remove the printer driver data file.

1. Double-click PnInst.exe.
2. Click [Next].
3. Click [Remove Preloaded Drivers].

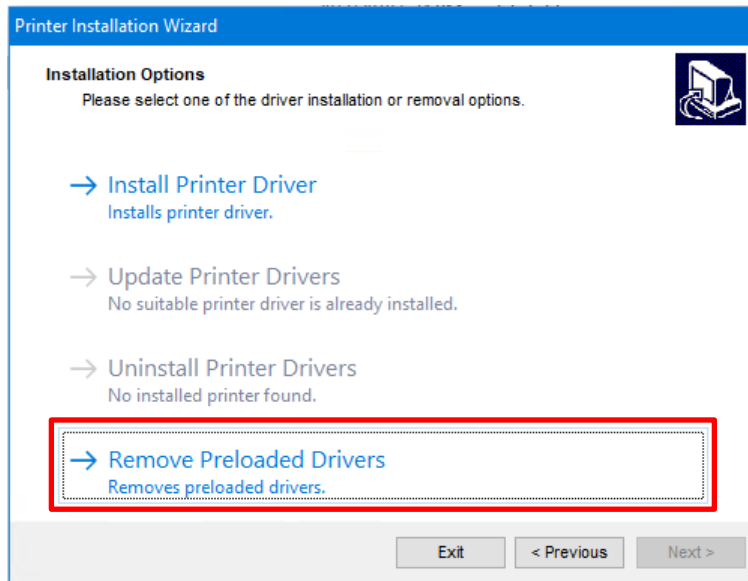

4. Select the check box for the printer driver data that you want to delete and click [Next].

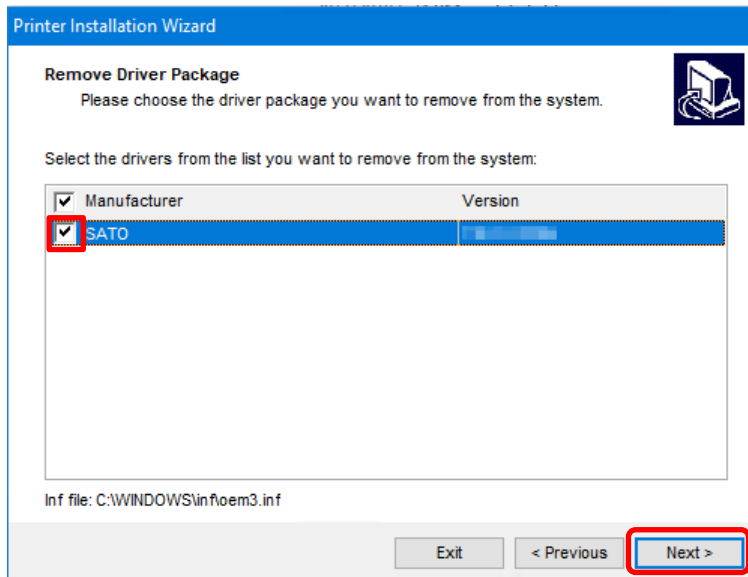

The removal procedure starts.

5. Confirm that [succeeded] is shown for the deleted printer driver and click [Exit].

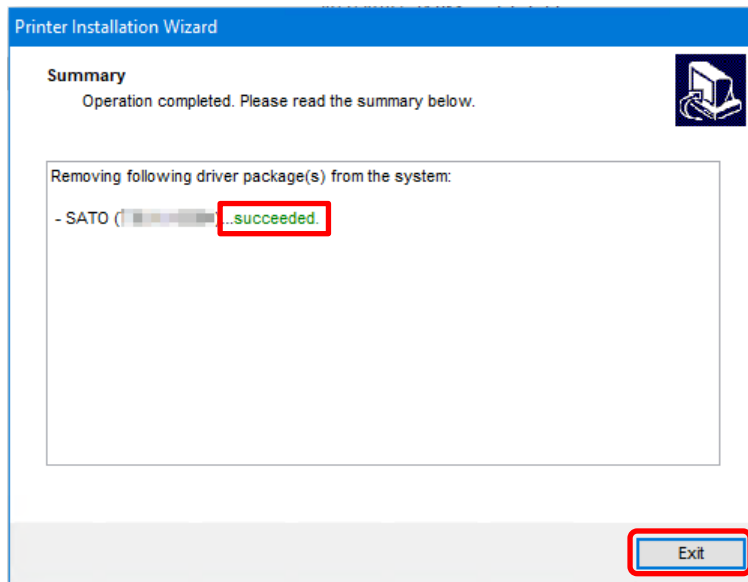

9. Checking the Printer Driver Version

To check the version of the currently installed printer driver, display the [About] tab.

1. Open [Devices and Printers], right-click the desired printer driver, and select [Printer properties].

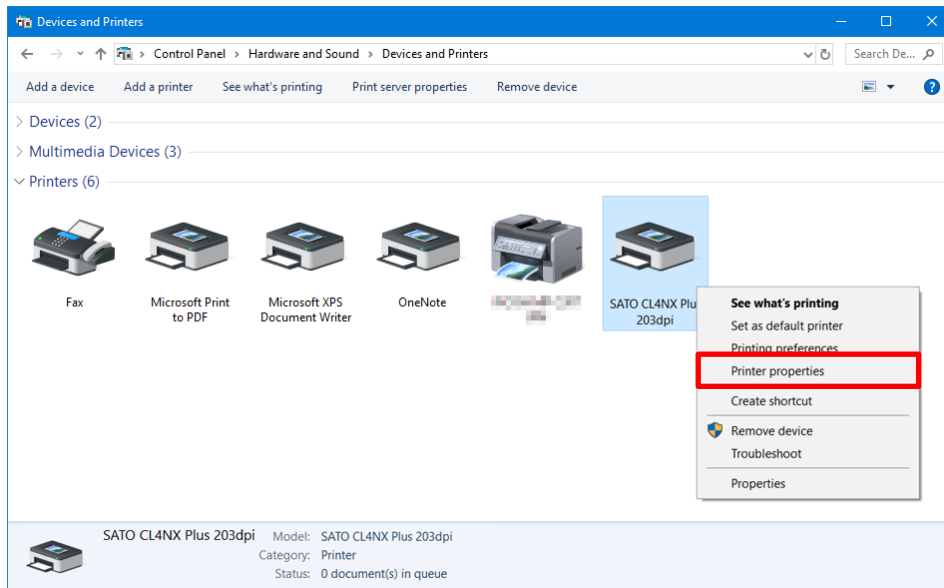

2. Select the [About] tab.

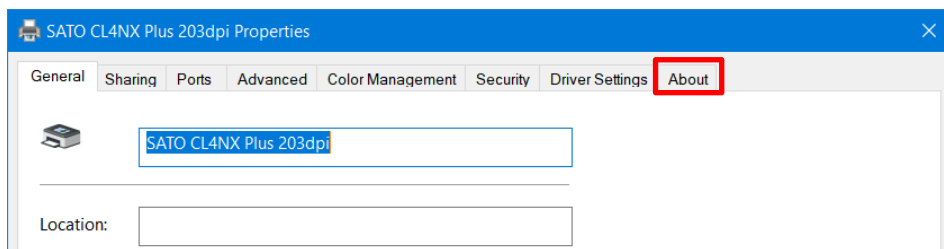

The version information appears.

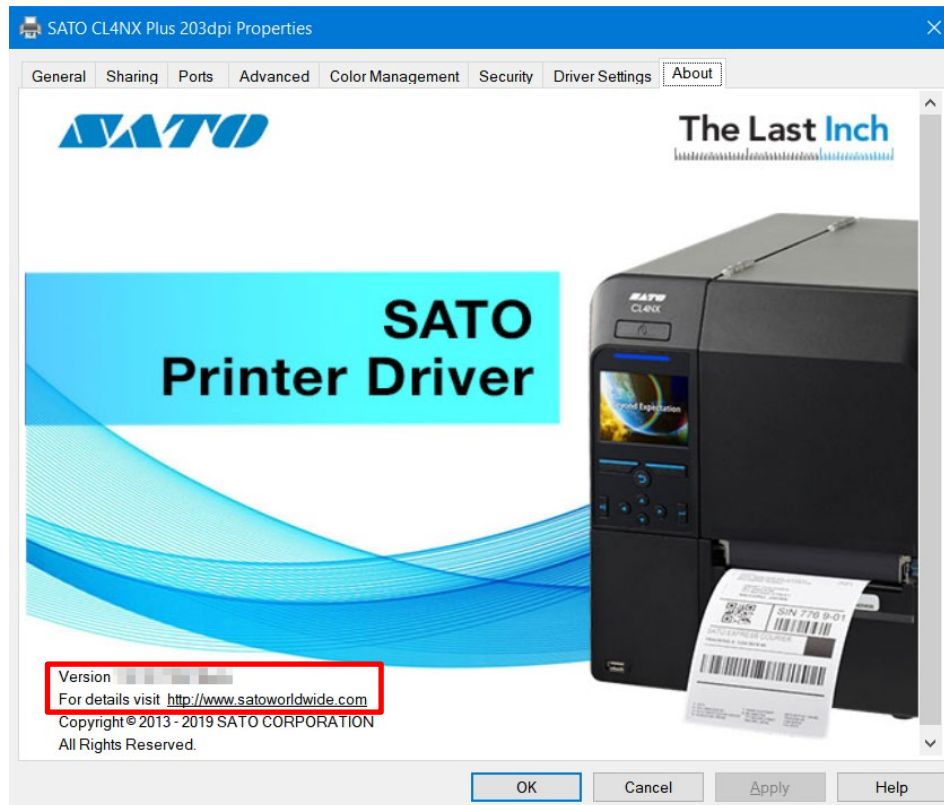

[Version]

This is the version of the currently installed printer driver.

[For details visit]

This is the URL for our website on which you can download printer drivers and manuals. If you are connected to the Internet, you can click the URL to display the website.

Checking the Version Information When Setting up the Product

You can check the version information by clicking the [About] tab regardless of whether [Configure Printer] is shown for [Printing Defaults] (for all users) or [Printing Preferences] (for individual users).

[Printing Defaults] screen

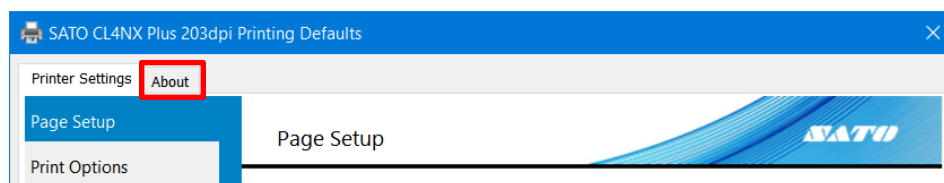

[Printing Preferences] screen

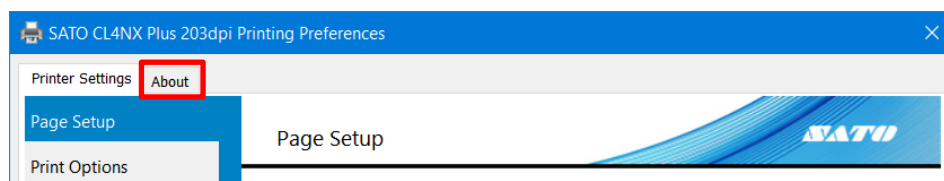

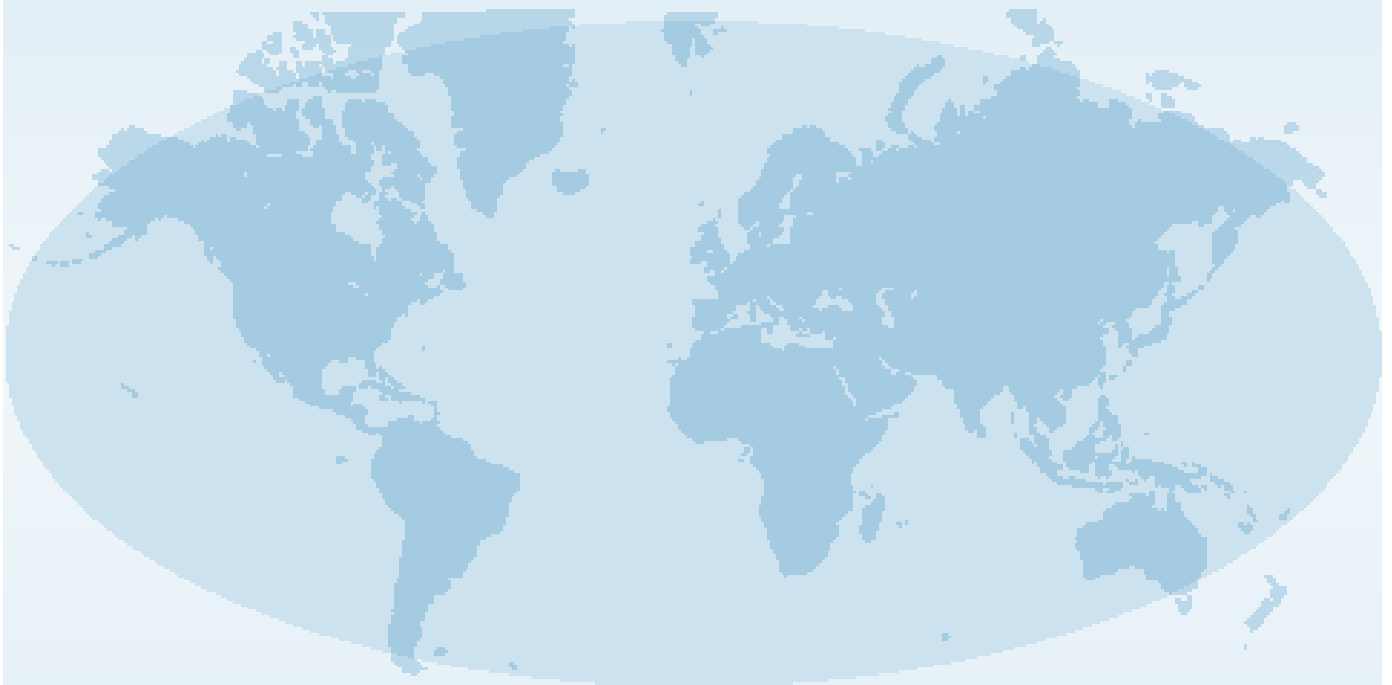

Extensive contact information for worldwide SATO operations can be found on the Internet at www.satoworldwide.com

SATO