



# Operator Manual

For printer model:

**HR2 Series**



Read this Operator Manual before using this product.  
Keep this document available for future reference.

**NOTE:**

The printer complies with the requirements in Part 15 of FCC Rules for a Class B Computing Device. Operating the printer in a residential area may cause unacceptable interference to radio and TV reception. If the interference is unacceptable, you can reposition the equipment, which may improve reception.

**Be sure to ask your SATO representatives about our maintenance contracts to ensure peace of mind during your usage of SATO products.**

**Please visit our SATO home page at [www.satoworldwide.com](http://www.satoworldwide.com) for extensive contact information of our worldwide SATO Group Member Company closest to your location.**

**Copyrights**

Any unauthorized reproduction of the contents of this document, in part or whole, is strictly prohibited.

**Limitation of Liability**

SATO Corporation and its subsidiaries in Japan, the U.S and other countries make no representations or warranties of any kind regarding this material, including, but not limited to, implied warranties of merchantability and fitness for a particular purpose. SATO Corporation shall not be held responsible for errors contained herein or any omissions from this material or for any damages, whether direct, indirect, incidental or consequential, in connection with the furnishing, distribution, performance or use of this material.

Specifications and contents in this document are subject to change without notice.

**Trademarks**

SATO is a registered trademark of SATO Corporation and its subsidiaries in Japan, the U.S. and other countries. All other trademarks are the property of their respective owners.

Version: GBS-HR2-01rB-18-10-12OM

©2012 SATO Corporation.



All rights reserved.

# Safety Precautions

Please read the following information carefully before installing and using the printer.

## Pictographic Symbols

This instruction manual and the printer labels use a variety of pictographic symbols to facilitate safe and correct use of the printer and to prevent injury to others and property damage. The symbols and meanings for them are given below. Be sure to understand these symbols well before reading the main text.

 <b>Warning</b>	Ignoring the instructions marked by this symbol and erroneously operating the printer could result in death or serious injury.
 <b>Caution</b>	Ignoring the instructions marked by this symbol and erroneously operating the printer could result in injury or property damage.

## Example Pictographs





The  pictograph means "Caution is required." A specific warning symbol is contained inside this pictograph (The symbol at left is for electric shock).





The  pictograph means "Should not be done." What is specifically prohibited is contained in or near the pictograph (The symbol at left means "Disassembly prohibited").



















The  pictograph means "Must be done." What is specifically to be done is contained in the pictograph (The symbol at left means "Unplug the power cord from the outlet").

 <b>Warning</b>		
<p><b>Do not set on an unstable area</b></p> <ul style="list-style-type: none"> <li>Do not set on an unstable area, such as a wobbly table or slanted area or an area subject to strong vibration. If the printer falls off or topples over, it could injure someone.</li> </ul> <p><b>Do not place containers full of water or other liquid on the printer</b></p> <ul style="list-style-type: none"> <li>Do not place flower vases, cups, or other containers holding liquids, such as water or chemicals, or small metal objects near the printer. If they are spilled and get inside the printer, immediately turn off the power switch, unplug the power cord from the outlet, and contact your SATO reseller or technical support center. Using the printer in this condition could cause a fire or electric shock.</li> </ul> <p><b>Do not put objects inside the printer</b></p> <ul style="list-style-type: none"> <li>Do not insert or drop in metal or burnable objects inside the printer's openings (cable outlets, etc.). If foreign objects do get inside the printer, immediately turn off the power switch, unplug the power cord from the outlet, and contact your SATO reseller or technical support center. Using the printer in this condition could cause a fire or electric shock.</li> </ul>	<p><b>Do not use other than the specified voltage</b></p> <ul style="list-style-type: none"> <li>Do not use other than the specified voltage. Doing so could result in fire or electric shock.</li> </ul> <p><b>Always ground the connections</b></p> <ul style="list-style-type: none"> <li>Always connect the printer's ground wire to a ground. Not grounding the ground wire could result in electric shock.</li> </ul> <p><b>Handling of the power cord</b></p> <ul style="list-style-type: none"> <li>Do not damage, break, or modify the power cord. Also, do not place heavy objects on the power cord, heat it, or pull it because doing so could damage the power cord and cause a fire or electric shock.</li> <li>If the power cord becomes damaged (core is exposed, wires broken, etc.), contact your SATO reseller or technical support center. Using the power cord in this condition could cause a fire or electric shock.</li> <li>Do not modify, excessively bend, twist, or pull the power cord. Using the power cord in such a condition could cause a fire or electric shock.</li> </ul>	<p><b>When the printer has been dropped or broken</b></p> <ul style="list-style-type: none"> <li>If the printer is dropped or broken, immediately turn off the power switch, unplug the power cord from the outlet, and contact your SATO reseller or technical support center. Using the printer in this condition could cause a fire or electric shock.</li> </ul> <p><b>Do not use the printer when something is abnormal about it</b></p> <ul style="list-style-type: none"> <li>Continuing to use the printer in the event something is abnormal about it, such as smoke or unusual smells coming from it, could result in fire or electric shock. Immediately turn off the power switch, unplug the power cord from the outlet, and contact your SATO reseller or technical support center for repairs. It is dangerous for the customer to try to repair it, so absolutely do not attempt repairs on your own.</li> </ul> <p><b>Do not disassemble the printer</b></p> <ul style="list-style-type: none"> <li>Do not disassemble or modify the printer. Doing so could result in fire or electric shock. Contact your SATO reseller or technical support center to conduct internal inspections, adjustments, and repairs.</li> </ul>

Safety Precautions

 <b>Warning</b>		
<p><b>Using the head cleaning fluid</b></p> <ul style="list-style-type: none"> <li> Use of flame or heat around the head cleaning fluid is prohibited. Absolutely do not heat it or subject it to flames.</li> <li> Keep the fluid out of reach of children to prevent them from accidentally drinking it. If the fluid is drunk, immediately consult with a physician.</li> </ul>		

 <b>Caution</b>		
<p><b>Do not place in areas with high humidity</b></p> <ul style="list-style-type: none"> <li> Do not place the printer in areas with high humidity or where condensation forms. If condensation forms, immediately turn off the power switch and do not use the printer until it dries. Using the printer while condensation is on it could result in electric shock.</li> </ul> <p><b>Carrying the Printer</b></p> <ul style="list-style-type: none"> <li> When moving the printer, always unplug the power cord from the outlet and check to make sure all external wires are disconnected before moving it. Moving the printer with the wires still connected could damage the cords or connecting wires and result in a fire or electrical shock.</li> <li> Do not carry the printer with paper loaded in it. The paper could fall out and cause an injury.</li> <li> When setting the printer on the floor or a stand, make sure not to get your fingers or hands pinched under the printer feet.</li> </ul>	<p><b>Power supply</b></p> <ul style="list-style-type: none"> <li> Do not operate the power switch or plug in/unplug the power cord with wet hands. Doing so could result in electric shock.</li> </ul> <p><b>Power cord</b></p> <ul style="list-style-type: none"> <li> Keep the power cord away from hot devices. Getting the power cord close to hot devices could cause the cord's covering to melt and cause a fire or electrical shock.</li> <li> When unplugging the power cord from the outlet, be sure to hold it by the plug. Pulling it by the cord could expose or break the core wires and cause a fire or electric shock.</li> <li> The power cord set that comes with the printer is especially made for this printer. Do not use it with any other electrical devices.</li> </ul> <p><b>Top cover</b></p> <ul style="list-style-type: none"> <li> Be careful not to get your fingers pinched when opening or closing the top cover. Also be careful the top cover does not slip off and drop.</li> </ul>	<p><b>Print head</b></p> <ul style="list-style-type: none"> <li> The print head is hot after printing. Be careful not to get burned when replacing paper or cleaning immediately after printing.</li> <li> Touching the edge of the print head immediately after printing could result in injury. Use caution when replacing the label or cleaning the print head.</li> <li> You should not replace the print head without having received the proper training.</li> </ul> <p><b>Loading paper</b></p> <ul style="list-style-type: none"> <li> When loading roll paper, be careful not to get your fingers pinched between the paper roll and the supply unit.</li> </ul> <p><b>When not using the printer for a long time</b></p> <ul style="list-style-type: none"> <li> When not using the printer for a long time, unplug the power cord from the outlet to maintain safety.</li> </ul> <p><b>During maintenance and cleaning</b></p> <ul style="list-style-type: none"> <li> When maintaining and cleaning the printer, unplug the power cord from the outlet to maintain safety.</li> </ul>

## Precautions for Installation and Handling

Printer operation can be affected by the printer environment.  
Refer to the following instructions for installation and handling of HR2 Series printer.

### Select a Safe Location

#### **Place the printer on a surface that is flat and level.**

If the surface is not flat and level, this may result in poor print quality. This may also cause malfunction and shorten the life span of the printer.

#### **Do not place the printer on a location that produces vibration.**

Giving serious vibration or shock to the printer may cause malfunction and shorten the life span of the printer.

#### **Keep the printer out of high temperature and humidity.**

Avoid locations subject to extreme or rapid changes in temperature or humidity.

#### **Do not place the printer in a location subject to water or oil.**

Do not place the printer in a location where it will be splashed with water or oil. Water or oil entering inside the printer may cause a fire, electric shock, or malfunction.

#### **Avoid dust.**

Dust build up may result in poor print quality.

#### **Keep out of direct sunlight.**

This printer has a built-in optical sensor. Exposure to direct sunlight will make the sensor less responsive and may cause the label to be sensed incorrectly. Close the top cover when printing.

### Power Supply

#### **This printer requires an AC power supply.**

Be sure to connect the printer to an AC power supply.

#### **Connect the power cord to a grounded power outlet.**

Make sure that the printer is plugged into a grounded power outlet.

#### **Provide a stable source of electricity to the printer.**

When using the printer, do not share its power outlet with other electrical devices that could result in power fluctuations and performance issues with your printer.

# TABLE OF CONTENTS

<b>Introduction</b>	<b>1 - 1</b>
1.1 Features of the Printer.....	1 - 2
1.2 Unpacking .....	1 - 2
1.2.1 Included Accessories.....	1 - 2
1.3 Parts Identification.....	1 - 3
<b>Installation</b>	<b>2 - 1</b>
2.1 Site Location.....	2 - 2
2.2 Media Selection.....	2 - 2
2.3 Loading Media.....	2 - 3
2.3.1 To load the label when using the dispenser .....	2 - 3
2.3.2 When operating in continuous mode for the first time.....	2 - 7
2.3.3 To load the media when operating in continuous mode .....	2 - 7
2.3.4 Overview of the media/ ribbon loading path .....	2 - 8
2.4 Loading the Carbon Ribbon .....	2 - 9
2.5 Removing the Carbon Ribbon.....	2 - 15
2.6 Basic Connections.....	2 - 17
2.6.1 Connecting the Interface board .....	2 - 17
2.6.2 To Configure the Connected Interface.....	2 - 18
2.6.3 Interface Combination.....	2 - 18
2.6.4 Connecting the Power Cable .....	2 - 19
2.6.5 Turning On the Power.....	2 - 20
2.6.6 Turning Off the Power .....	2 - 20
2.7 Connections of optional accessories.....	2 - 21
2.8 LCD Power Saving Mode .....	2 - 24
2.8.1 Turning off the LCD Backlight.....	2 - 24
2.8.2 Turning on the LCD Backlight.....	2 - 24
<b>Operation and Configuration</b>	<b>3 - 1</b>
3.1 Operator Panel.....	3 - 2
3.2 Operating Modes.....	3 - 5
3.3 ONLINE And OFFLINE Modes.....	3 - 8
3.3.1 Online Mode .....	3 - 8
3.3.2 Offline Mode .....	3 - 8
3.3.3 To Adjust the Screen Contrast.....	3 - 8
3.4 Adjustment Screen .....	3 - 9
3.5 Cancel Print Job Mode .....	3 - 11
3.6 User Mode.....	3 - 12
3.7 Interface Mode .....	3 - 15
3.7.1 Overview of Interface Mode Configurations .....	3 - 15
3.7.2 Enabling Interface Card Configuration.....	3 - 18
3.8 CARTRIDGE Mode .....	3 - 25
3.9 SEMBL Mode .....	3 - 27
3.10 Advanced Mode .....	3 - 28
3.11 HEX Dump Mode .....	3 - 34
3.12 Received Data Saving Mode.....	3 - 35
3.13 Test Print Mode .....	3 - 36
3.13.1 Types of Test Print.....	3 - 39
3.13.2 Explanation of the contents of each piece of Factory Test Print 1.....	3 - 39

3.13.3 Explanation of the contents of each piece of Factory Test Print 2.....	3 - 43
3.13.4 Explanation of the contents of Configuration Test Print.....	3 - 48
3.13.5 Print of Supported Barcodes.....	3 - 50
3.13.6 Print of Head Check.....	3 - 50
3.13.7 Print Head and Sensor Check .....	3 - 50
3.13.8 Memory State .....	3 - 50
3.13.9 Print of Supported Fonts.....	3 - 50
3.13.10 Print Test Pattern for Small Pitch Label.....	3 - 50
3.14 Default Setting Mode.....	3 - 51
3.14.1 Table of Default Settings .....	3 - 52
3.15 Maintenance Mode.....	3 - 55
3.16 Service Mode .....	3 - 56
3.16.1 Overview of Sensor Level adjustment in Service Mode.....	3 - 56
3.16.2 Pitch adjustment in Service Mode .....	3 - 58
3.16.3 Dispense or Tear off offset adjustment in Service Mode .....	3 - 60
3.16.4 Backfeed Offset adjustment in Service Mode .....	3 - 62
3.16.5 Overview of Setting menu in Service Mode .....	3 - 64
3.17 Download Mode .....	3 - 66
3.18 Upload Mode.....	3 - 70
<b>Cleaning and Maintenance</b> .....	<b>4 - 1</b>
4.1 Cleaning The Print Head, Platen and Rollers.....	4 - 2
4.2 How To Clean The Printer (Cleaning Kit).....	4 - 2
4.3 How To Clean The Printer (Cleaning Sheet).....	4 - 3
4.4 Adjusting Print Quality .....	4 - 4
4.4.1 Adjusting Print Darkness .....	4 - 4
4.4.2 Adjusting Print Speed .....	4 - 4
<b>Troubleshooting</b> .....	<b>5 - 1</b>
5.1 Error signal Troubleshooting .....	5 - 2
5.1.1 Error Message .....	5 - 2
5.1.2 More information about Command Error .....	5 - 6
5.1.3 Warning Message.....	5 - 7
5.2 Troubleshooting Table.....	5 - 8
5.3 Interface Troubleshooting.....	5 - 10
5.4 Test Print Troubleshooting .....	5 - 11
5.4.1 Hex Dump.....	5 - 11
5.4.2 Test label printing .....	5 - 11
<b>Basic Specifications</b> .....	<b>6 - 1</b>
6.1 Printer Basic Specifications.....	6 - 1
<b>Interface Specifications</b> .....	<b>7 - 1</b>
7.1 Interface Types.....	7 - 1
7.2 RS232C High Speed Serial Interface.....	7 - 2
7.2.1 Basic Specifications .....	7 - 2
7.2.2 Ready/Busy .....	7 - 3
7.2.3 X-ON/X-OFF .....	7 - 4
7.3 Universal Serial Bus (USB) Interface .....	7 - 5
7.3.1 Basic Specifications .....	7 - 5
7.3.2 Pin Assignments .....	7 - 5
7.4 Local Area Network (LAN) Ethernet.....	7 - 6
7.4.1 Basic Specifications .....	7 - 6

Table of Contents

7.4.2 Software Specifications .....	7 - 8
7.4.3 TCP/IP Specifications .....	7 - 8
7.4.4 LPD Specifications .....	7 - 8
7.4.5 FTP Specifications .....	7 - 8
7.4.6 TELNET Specifications .....	7 - 9
7.4.7 Setting/Displayed Items .....	7 - 10
7.4.8 Socket Connection .....	7 - 10
7.4.9 Operating Suggestions .....	7 - 11
7.5 External Signal Interface (EXT) .....	7 - 11
7.5.1 Basic Specifications .....	7 - 12
7.5.2 Pin Assignments .....	7 - 13
<b>Appendix</b> .....	<b>8 - 1</b>
8.1 Positions of Sensors and Options .....	8 - 2
8.2 Operation Mode Selection .....	8 - 3
8.3 Base Reference Point .....	8 - 4
8.4 Base Reference Point Adjustment .....	8 - 5
8.4.1 Adjustment of Print Position .....	8 - 5
8.4.2 Adjustment of Stop Position When Using Dispenser/ Tear-off .....	8 - 6
8.4.3 Adjustment of Stop Position in Tear-off Mode (only for the first label) .....	8 - 7
8.5 Paper End .....	8 - 8
8.5.1 Paper End Detection during Paper Feed .....	8 - 8
8.5.2 Paper end detection in print motion .....	8 - 8
8.6 Ribbon End .....	8 - 10
8.7 Rewinder Full .....	8 - 11



# 1

## INTRODUCTION

---

Thank you for your investment in this SATO printer product.

This Operator Manual contains the basic information about the installation, setup, configuration, operation and maintenance of the printer.

A total of eight topics are covered herein, and they are organized as follows:

- Section 1: Introduction
- Section 2: Installation
- Section 3: Operation and Configuration
- Section 4: Cleaning and Maintenance
- Section 5: Troubleshooting
- Section 6: Basic Specifications
- Section 7: Interface Specifications
- Section 8: Appendix

It is recommended that you read carefully and become familiar with each section before installing and maintaining the printer. Refer to the **TABLE OF CONTENTS** at the front of this manual to search for the relevant information needed. All page numbers in this manual consist of a section number followed by the page number within the stated section.

This section assists you in unpacking the printer from the shipping container. You will also be guided through a familiarization tour of the main parts and controls.

The following information is provided herein:

- Features of the printer
- Unpacking
- Parts Identification

## 1.1 FEATURES OF THE PRINTER

---

The SATO HR2 Series printers (Thermal Transfer) are complete, high-performance labeling systems designed specifically for printing labels.

The key features of the HR2 Series are:

- Full metallic durable casing
- High accuracy printer
- Large internal Memory Size (32MB Flash-ROM)
- Built-in multiple interfaces (USB, LAN or high speed RS-232C interface available)
- Easy Media loading
- Easy Maintenance

## 1.2 UNPACKING

---

When unpacking the printer, take note of the following:

2. The box should stay right-side up. Lift the printer out of the box carefully.
3. Remove all the packaging from the printer.
4. Remove the accessory items from their protective containers.
5. Set the printer on a solid, flat surface. Inspect the shipping container and printer for any sign of damage that may have occurred during shipping. Please note that SATO shall hold no liability of any damage of any kind sustained during shipping of the product.

### Notes:

- If the printer has been stored in the cold, allow it to reach room temperature before turning it on.
- Please do not discard the original packaging box and cushioning material after installing the printer. They may be needed in future, if the printer needs to be shipped for repairs.

### 1.2.1 Included Accessories

After unpacking the printer, verify that you have the following materials:

User Documents  
(Quick Guide, Warranty, etc)

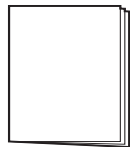

Power plug\*

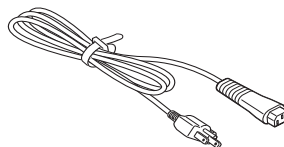

Roll Holders (x2)

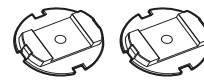

Ribbon Adapters (x2)

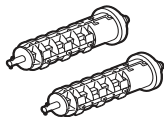

Core clip, Rewinder

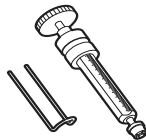

\* The shape of the power plug may vary, depending on the location where it was purchased.

## 1.3 PARTS IDENTIFICATION

---

### Front view

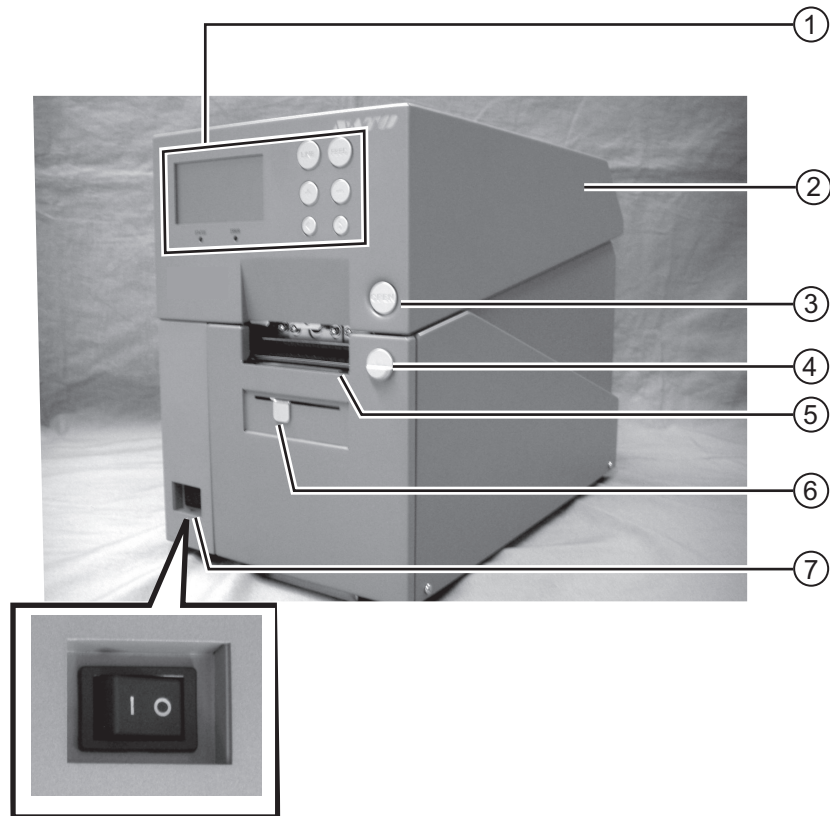

- 
- |   |  |
|---|--|
| <p>① <b>Operator panel</b><br/>It consists of six contact buttons and two LED indicators. Please refer to <b>Section 3.1 Operator Panel</b>.</p> <p>② <b>Top cover</b><br/>Open this cover to load the media and ribbon.</p> <p>③ <b>OPEN button</b><br/>Press this button to open the Top cover.</p> <p>④ <b>Dispenser unit open button</b><br/>Slide this button downwards to open the cover of the Dispenser unit.</p> | <p>⑤ <b>Label issuing slot</b><br/>Labels are issued from this slot.</p> <p>⑥ <b>Dispenser sensor sliding knob</b><br/>To adjust the position of the dispenser sensor.</p> <p>⑦ <b>Power (I/O) switch</b><br/>Press this switch to turn the power on (I) or off (O).</p> |
|---|--|

## 1.3 PARTS IDENTIFICATION (cont'd)

---

### Back view

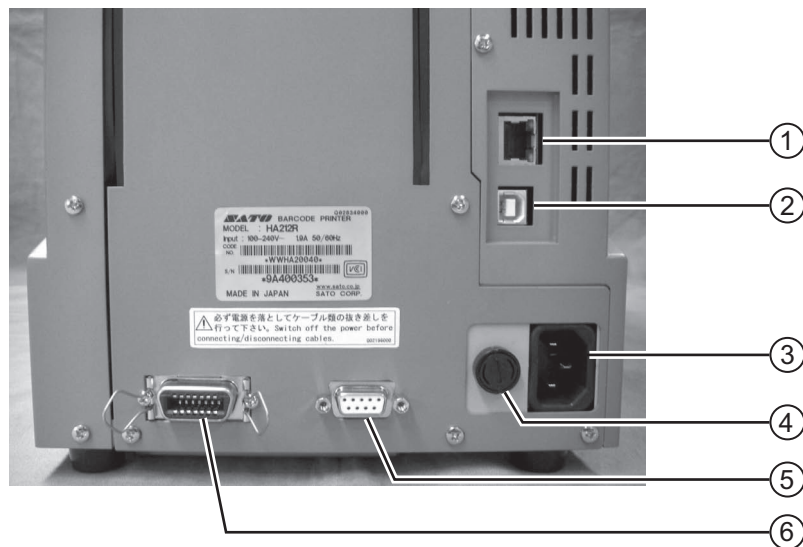

---

① **LAN Interface connector**

To connect printer to the host computer using the LAN interface.

② **USB Interface connector**

To connect printer to the host computer using the USB interface.

③ **AC IN power terminal**

Supplies power to the printer by inserting the power cable.

Before connection, ensure that the AC voltage of your region is within the range of AC 100 to 240V, 50/60 Hz.

④ **FUSE (F-400-01A2) holder**

Used to hold a fuse which protect the printer from unstable power supply surge. Use fuse with rating, 250V/5A -LF (218 005.MXP) only.

⑤ **RS-232C (DSUB9 pin-female) Interface connector**

To connect printer to the host computer using the RS232C serial interface.  
Or, to connect to the optional SATO keypad.

⑥ **External connector terminal (EXT)**

Interface connector for external signals. Connect the optional application to this terminal.

### 1.3 PARTS IDENTIFICATION (cont'd)

---

#### Internal view when Top cover is opened

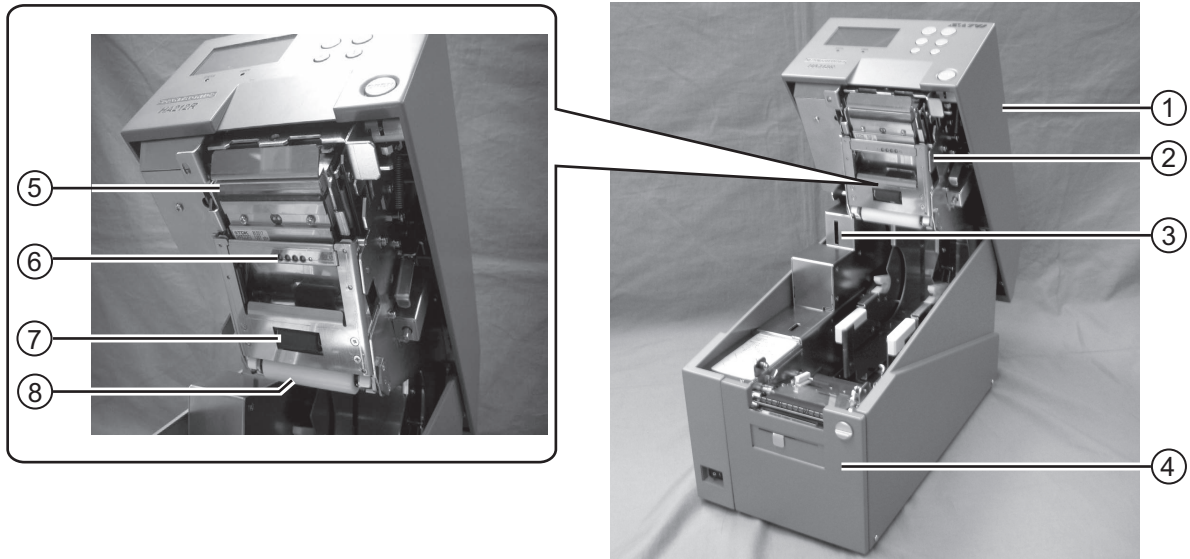

- 
- |   |   |
|---|---|
| <p>① <b>Top cover</b></p>   | <p>⑤ <b>Print head assembly</b><br/>This component is used to print on the media. Perform maintenance at regular intervals.</p> |
| <p>② <b>Ribbon unit</b><br/>A unit for loading ribbon.</p>                                | <p>⑥ <b>Label sensor</b><br/>Used to sense label during printing.</p>   |
| <p>③ <b>SD Card Slot</b><br/>To insert SD card for additional memory up to 2 GB.</p>      | <p>⑦ <b>Pinch roller</b><br/>Used to pinch the roll media.</p>  |
| <p>④ <b>Dispenser unit</b><br/>A unit to peel off label automatically after printing.</p> | <p>⑧ <b>Guide roller</b><br/>Roller to guide the roll media.</p>  |

### 1.3 PARTS IDENTIFICATION (cont'd)

---

#### Internal view when Ribbon unit is opened

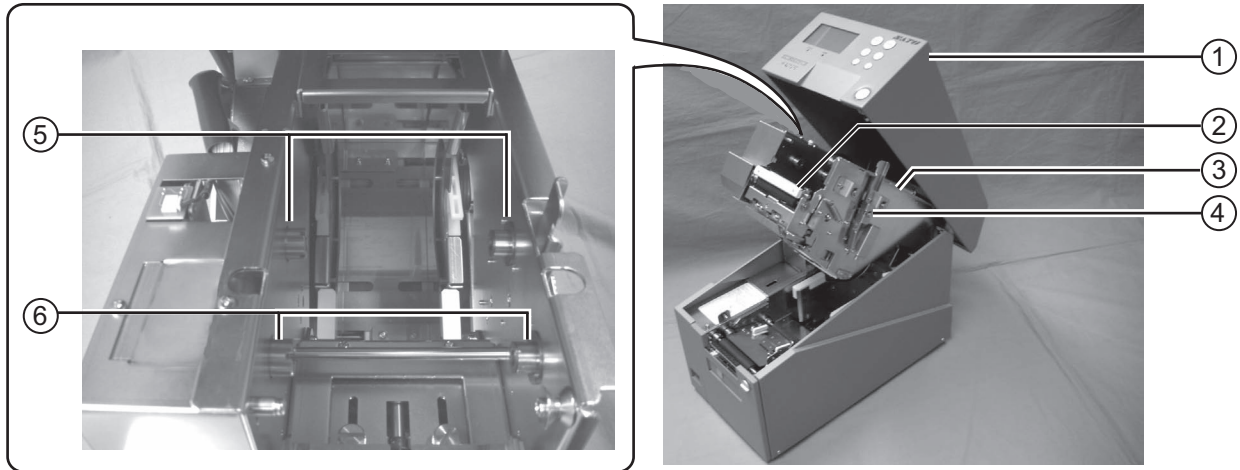

---

① **Top cover**

② **Ribbon pinch lever**  
Used to pinch the ribbon.

③ **Ribbon unit**  
A unit for loading ribbon.

④ **Ribbon unit lever**  
Press this lever to release ribbon unit from the top cover.

⑤ **Ribbon supply shaft bearing**  
To hold the Ribbon supply shaft.

⑥ **Ribbon rewind shaft bearing**  
To hold the Ribbon rewind shaft.

**1.3 PARTS IDENTIFICATION (cont'd)**

**Media and Rollers Section**

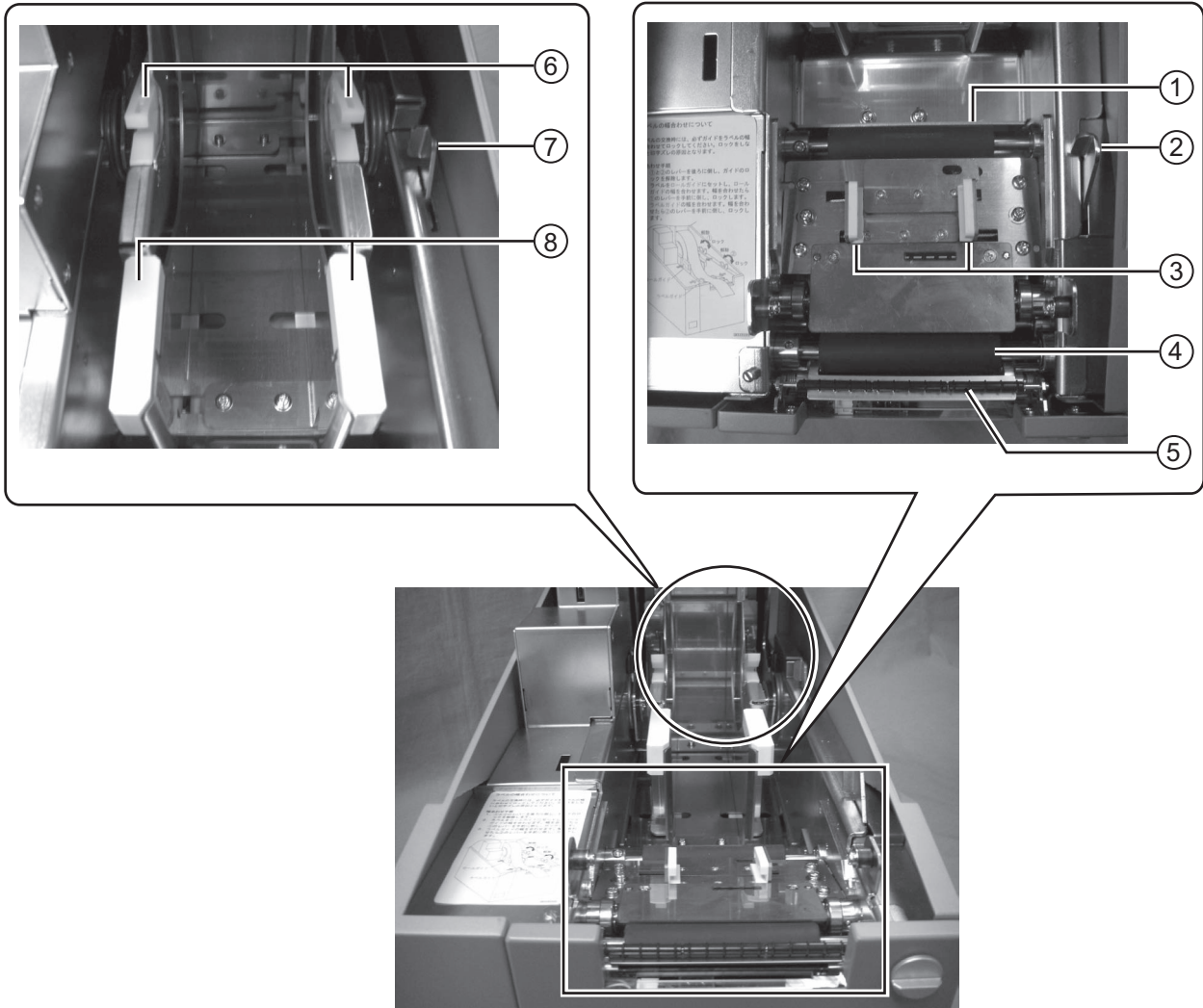

- ① **Feed roller**  
Enable smooth feeding of the label.
- ② **Label guide lock lever**  
Used to lock the label guide.
- ③ **Label guide**  
Used to guide the label.
- ④ **Platen roller**  
Enable smooth movement of the label during printing.

- ⑤ **Dispenser roller**  
Enable smooth movement of the label during dispensing.
- ⑥ **Roll shaft bearing**  
Used to latch roll holder.
- ⑦ **Roll media guide lock lever**  
Used to lock the roll media guide.
- ⑧ **Roll media guide**  
Set to meet the size of the media used.

## 1.3 PARTS IDENTIFICATION (cont'd)

---

### Operating Panel

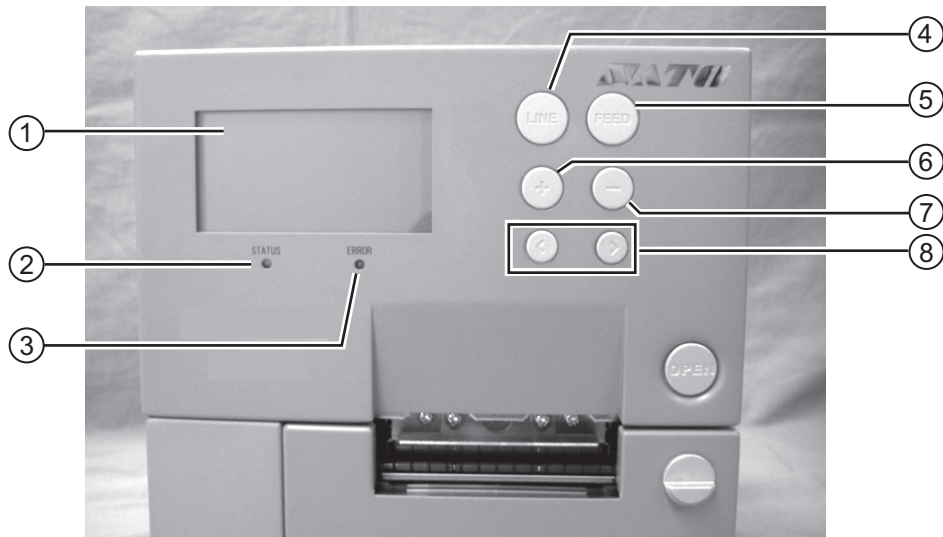

---

① **LCD screen**

Displays various information such as printer modes and settings.

② **STATUS LED**

Indicates current status of the printer.

③ **ERROR LED**

Indicates the printer is in error state.

④ **LINE button**

Press this button to toggle between printer modes or go back to previous setting in various modes

⑤ **FEED button**

Press this button to start/stop printing or feed the label.

⑥ **+ button**

Increment value in various modes.

⑦ **- button**

Decrement value in various modes.

⑧ **Arrow buttons**

Press to move the cursor left or right in various modes.



# 2

## INSTALLATION

---

This section assists you in general printer set up and installing consumable media in the printer, as well as interface connection with host computer and other optional attachment units.

The following information is provided:

- 2.1 Site Location
- 2.2 Media Selection
- 2.3 Loading Media
- 2.4 Loading the Carbon Ribbon
- 2.5 Removing the Carbon Ribbon
- 2.6 Basic Connections
- 2.7 Connections of optional accessories
- 2.8 LCD Power Saving Mode

## 2.1 SITE LOCATION

Consider the following when setting up the printer:

- Place the printer on a solid flat surface with adequate space. Make sure there is enough space above the printer to provide clearance for the top cover to swing open.
- Place it away from hazardous materials or dusty environments.
- Place it within operational distance of the host computer, within interface cable specifications.

## 2.2 MEDIA SELECTION

The size and type of the labels to be printed should have been taken into consideration before printer purchase. Ideally, the media width will be equal to, or just narrower than, the print head. Using media that does not cover the print head will allow the platen roller to tread on it and wear it out. The media edge will also wear a groove in the platen roller, which can affect print quality.

**Note:**

For optimal print performance and durability, **please use SATO-certified media and ribbon supplies on this printer.** Using supplies not tested and approved for use by SATO can result in unnecessary wear and damage to vital parts of the printer, and may void the warranty.

This printer can use 2 different types of media, the figures below identifies the media types and their specifications. The printer uses different sensors to detect the I-Marks or Gap on the media in order to precisely position the print content.

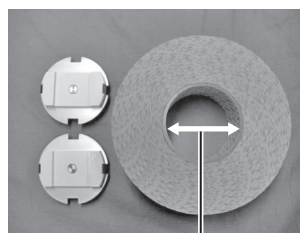
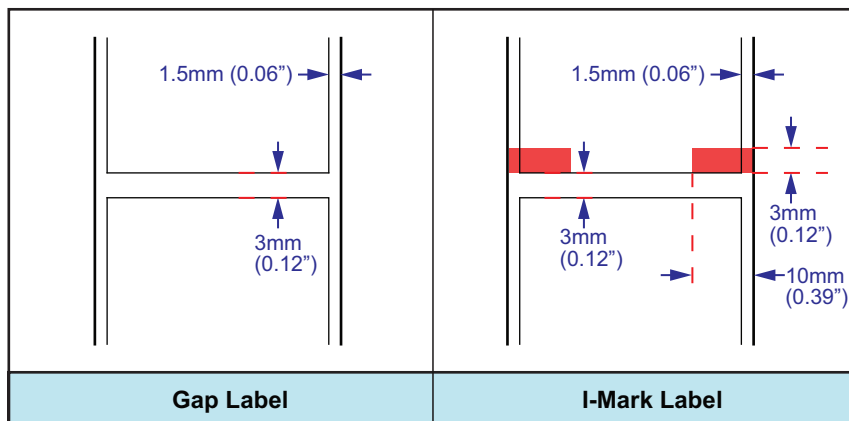

76.4mm (3")

## 2.3 LOADING MEDIA

### 2.3.1 To load the label when using the dispenser

1. Lift up the **Top cover** while holding down the **OPEN button**.  
Slide down the **Dispenser unit open button** to open the dispenser unit.

**Note:**

Make sure that the cover rests firmly so that it will not fall forward and injure your hands.

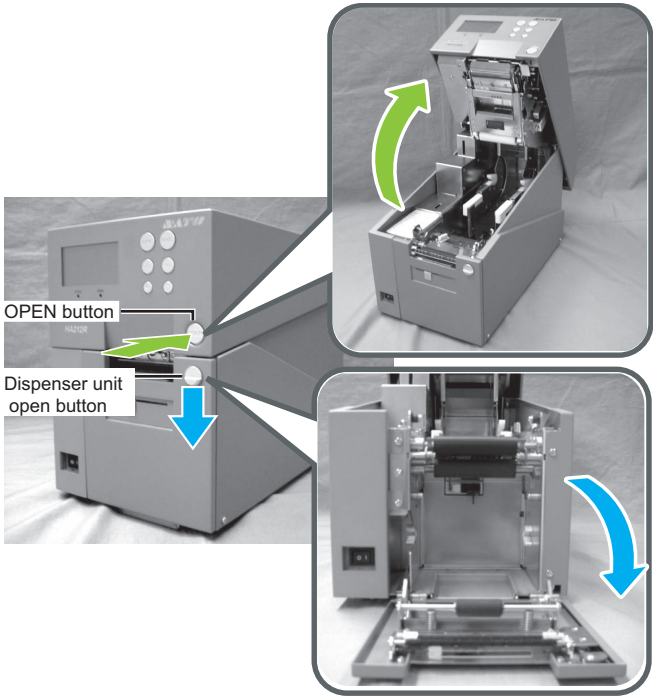

2. Attach the supplied **roll holders** to the left and right sides of the roll media respectively.

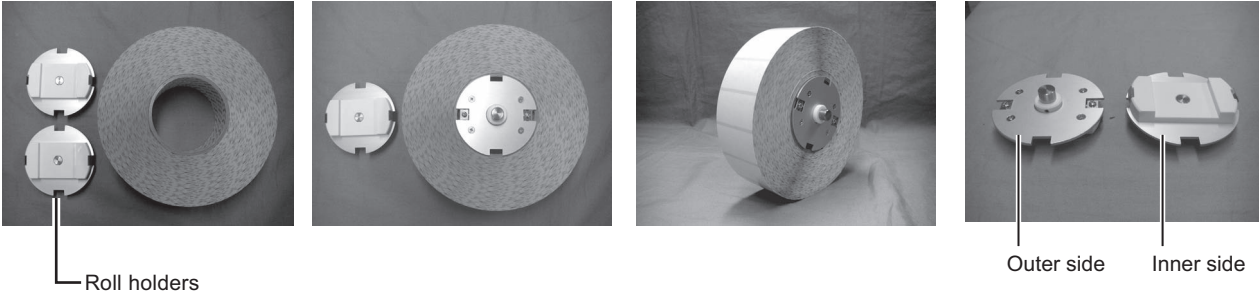

## 2.3 LOADING MEDIA (cont'd)

---

3. Release the **lock levers** of **roll media guide** and **label guide**.

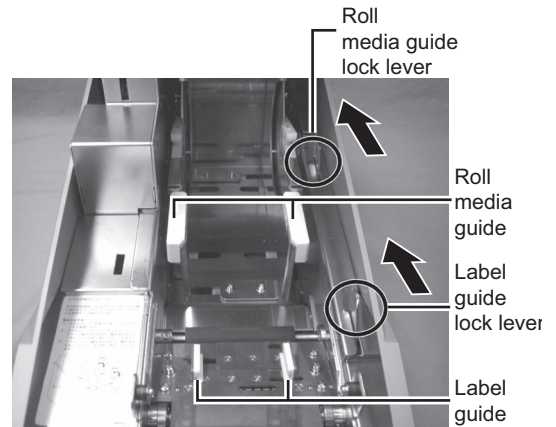

4. Slide the **roll media guide** to the width of the roll media and then load the media by latching the Roll media assembly to the **roll shaft bearing**.

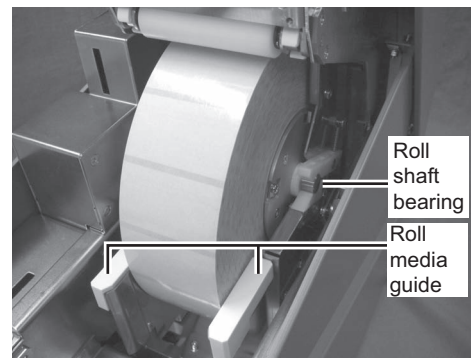

5. Slide the label guide so that it fits the label width. After alignment, lock the levers of **roll media guide** and **label guide**.

**Notes:**

Make sure the media leader is pulled out from the top and the printed side is facing upwards. Push the roll firmly towards the end of the roll shaft bearing.

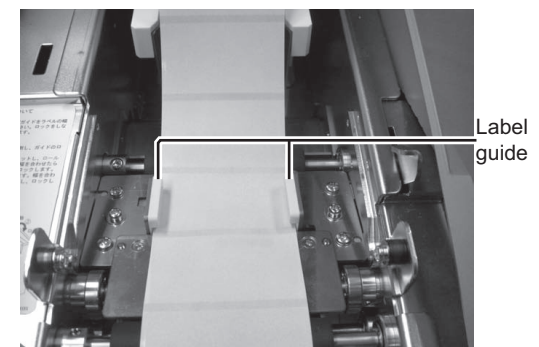

**2.3 LOADING MEDIA (cont'd)**

- 6. Align the liner (backing paper) by referring to the scale of the rewinder and wrap it to the rewinder in clockwise direction. Then secure it with the clip.



After clipping, rewind the liner (backing paper) more than 3 turns (150 mm).

- 7. Push the rewinder onto the rewinder shaft bearing until you hear a “tick” sound.

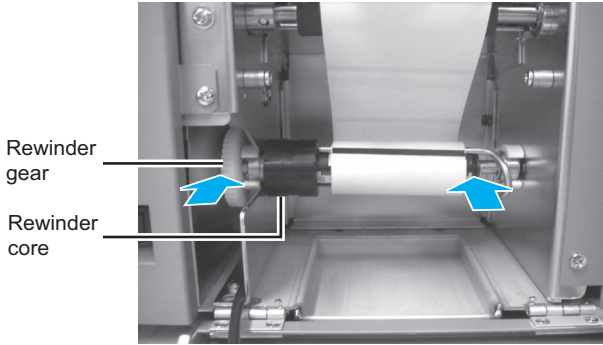

- 8. Turn the rewinder until the label to be printed reaches the platen roller.

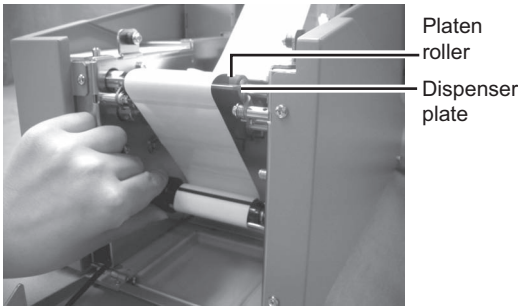

## 2.3 LOADING MEDIA (cont'd)

---

9. Close the dispenser unit.

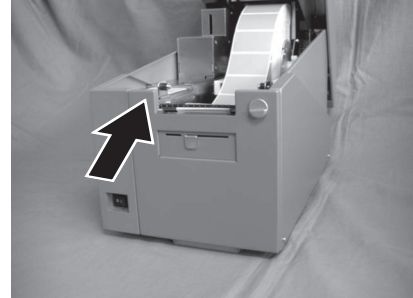

10. If the label is not taut, roll the media in the arrow direction, close the **top cover**.

You may need to set the Dispenser sensor adjustment. Refer to **Section 8.4.2 Adjustment of Stop Position When Using Dispenser/ Tear-off** for more details.

**Note:**

Be careful not to get your fingers caught at the bottom edge when you are closing the top cover.

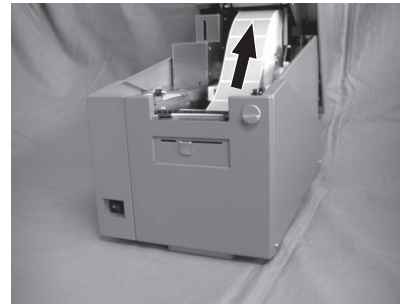

**Caution**

- When replacing media, bear in mind that the print head and its surrounding area remain hot. Keep your fingers away from these areas to prevent injury.
- Avoid touching even the edge of the print head with your bare hands.

## 2.3 LOADING MEDIA (cont'd)

### 2.3.2 When operating in continuous mode for the first time

1. Slide down the **Dispenser unit open button** to open the dispenser unit.
2. Remove the dispenser roller mounted in the dispenser unit.  
While pushing the dispenser roller downwards, pull towards your side to remove it.

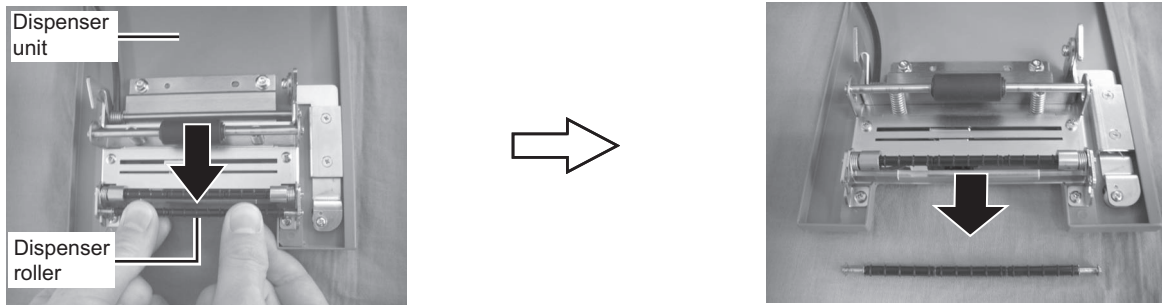

#### Notes:

- Keep the dispenser roller in a safe place.
- Mount with the reversed procedures when you need to issue labels in dispense mode.

3. Close the dispenser unit.

### 2.3.3 To load the media when operating in continuous mode

1. Lift up the **Top cover** while holding down the **OPEN button**.

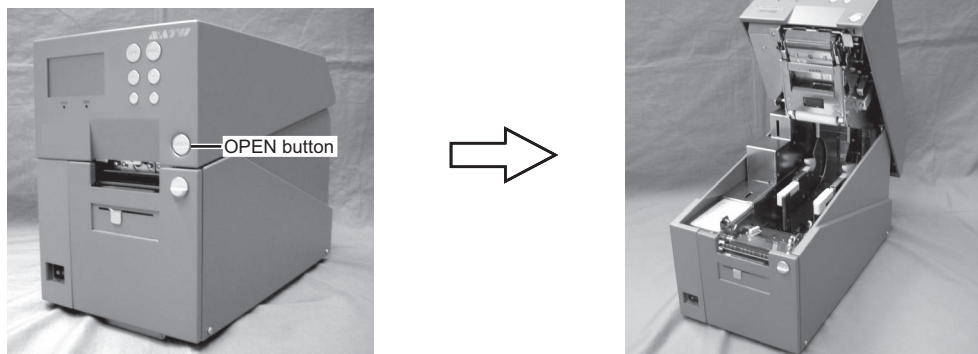

2. Load the media. (Refer to steps 2~5 of **Section 2.3.1 To load the label when using the dispenser**)
3. Close the top cover.

## 2.3 LOADING MEDIA (cont'd)

---

### 2.3.4 Overview of the media/ ribbon loading path

**Note:**

You may also refer to the sticker pasted on the inner side of the top cover for the media/ ribbon loading path.

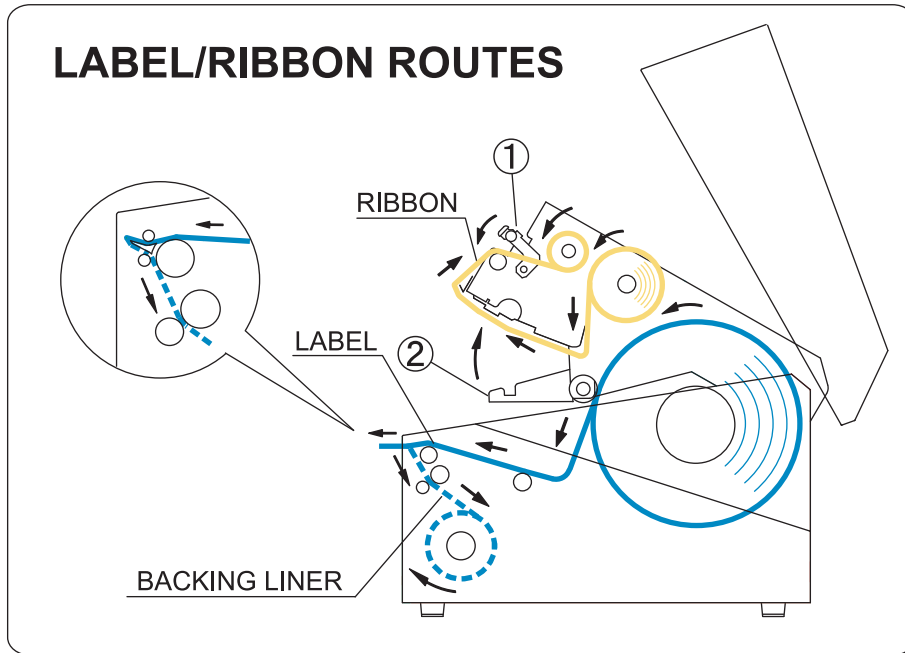



### 2.4 LOADING THE CARBON RIBBON

The HR2 series printer enables **Thermal transfer** printing. **Thermal transfer** paper media requires the use of carbon ribbon for print application. In such a scenario, it is the carbon ribbon that contains the ink that will be transferred to the media.

 **Caution**

- When replacing carbon ribbon, bear in mind that the print head and its surrounding area remain hot. Keep your fingers away from these areas to prevent injury.
- Avoid touching even the edge of the print head with your bare hands.

**1.** Prepare the carbon ribbon and ribbon rewind core.

Use the provided **ribbon adapter** to load the carbon ribbon and the ribbon rewind core. The position of the **ribbon stopper** varies depending on the width of the carbon ribbon.

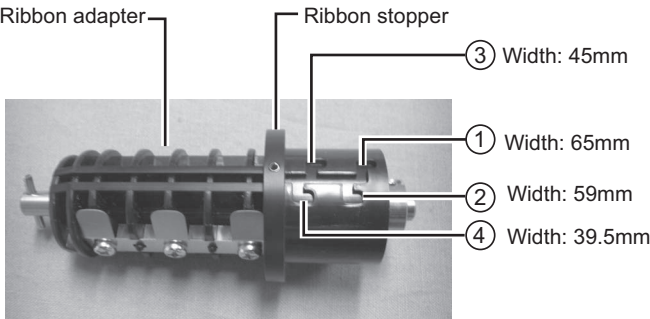

**Example:**  
**When the ribbon width is 65mm**  
Set the ribbon stopper position to ①.

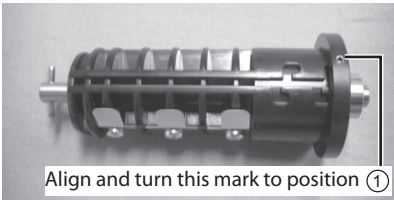

**2.** Insert the ribbon adapter all the way into the carbon ribbon, while taking note of the ribbon winding direction.

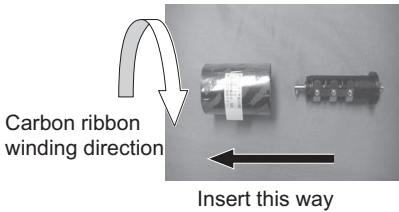

## 2.4 LOADING THE CARBON RIBBON (cont'd)

---

3. Insert the ribbon adapter all the way into the ribbon rewind core.  
When loading the carbon ribbon for the first time, use the empty **ribbon rewind core** supplied with the printer. However, the subsequent ribbon core can be obtained from the last used up ribbon roll.

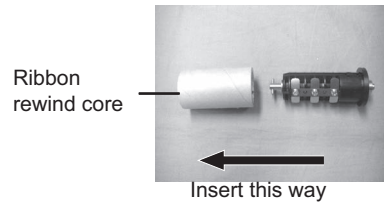

4. Press the **ribbon unit lever** to release the ribbon unit.  
**Note:**  
When loading the carbon ribbon, make sure that the top cover is fully opened.

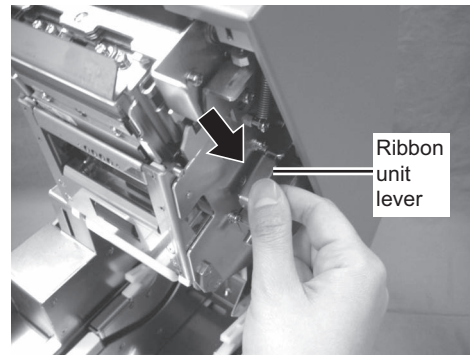

5. Hold two corners of the **pinch roller unit** and pull it in the arrow direction to unlatch.

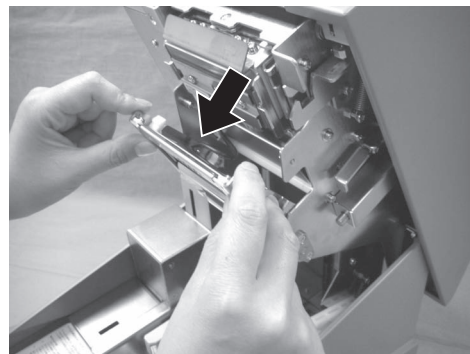
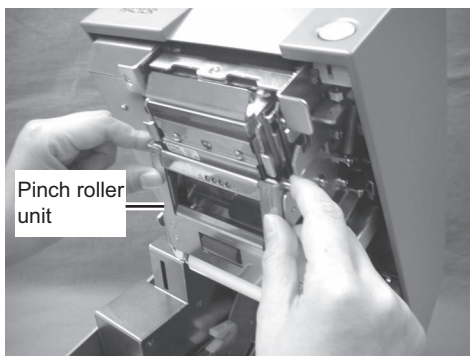

6. Lift down the ribbon unit and push the ribbon pinch lever upwards.

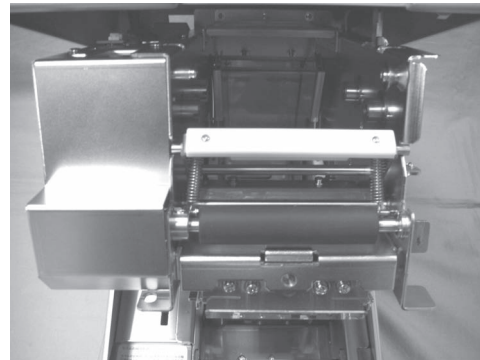
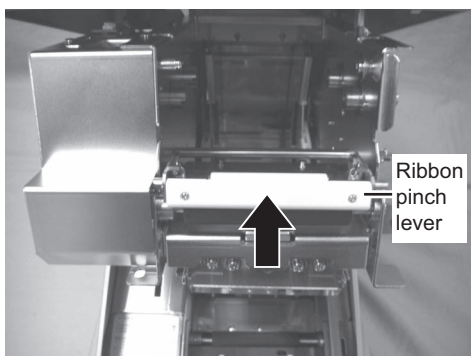

**2.4 LOADING THE CARBON RIBBON (cont'd)**

- 7. Load the carbon ribbon from the right side and make sure it latches into the ribbon supply shaft bearing firmly.  
Push in the ribbon shaft assembly to the right side of the **ribbon supply shaft bearing**. Then fix the other side of the ribbon shaft assembly to the left of the **ribbon supply shaft bearing**. Turn the ribbon shaft until the cross shape shaft snaps on the groove of the left **ribbon supply shaft bearing**.

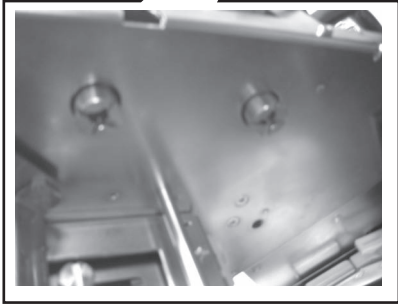
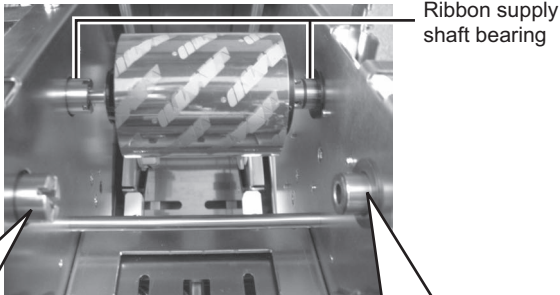
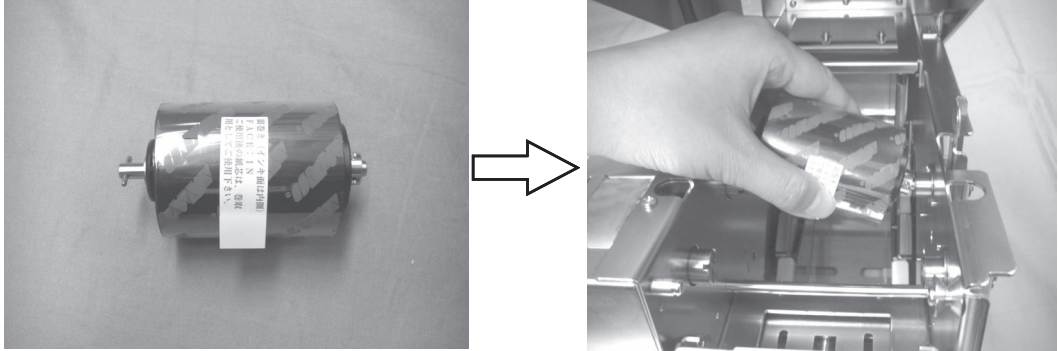

Align to the cross-shape shaft bearing when latching the ribbon.

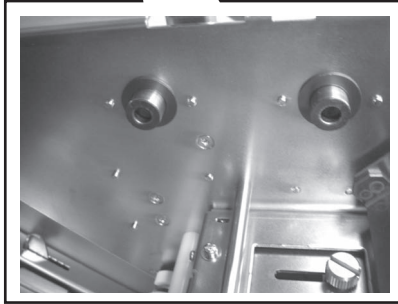

Align to the round shape shaft bearing when latching the ribbon.

**Note:**  
Use only genuine SATO carbon ribbons for maximum print quality and printer durability.

## 2.4 LOADING THE CARBON RIBBON (cont'd)

8. Load the ribbon rewind core to the rewinding side.  
The procedures are same as when loading to the supplying side.

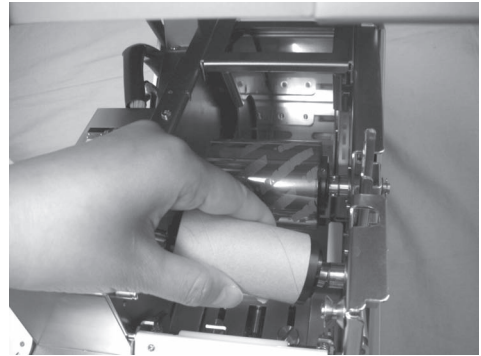

9. From the ribbon supply shaft bearing, pass the carbon ribbon underneath the print head assembly to the ribbon rewind shaft bearing.  
**Route the ribbon between the ribbon pinch lever and ribbon roller** towards the ribbon rewind core. Then route the ribbon behind and over the top of the ribbon rewind core. Paste the leader portion of the carbon ribbon onto the ribbon rewind core.

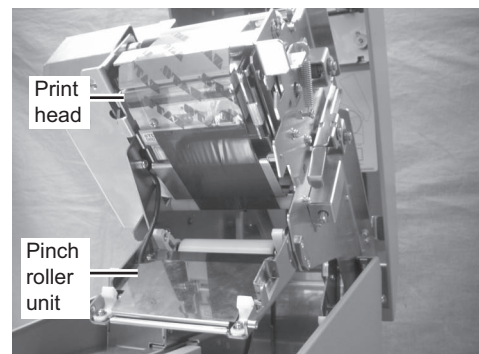
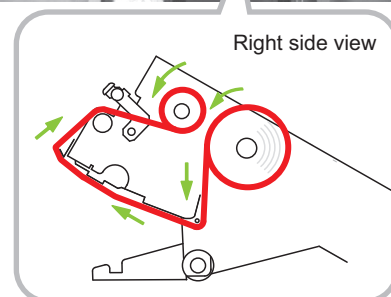
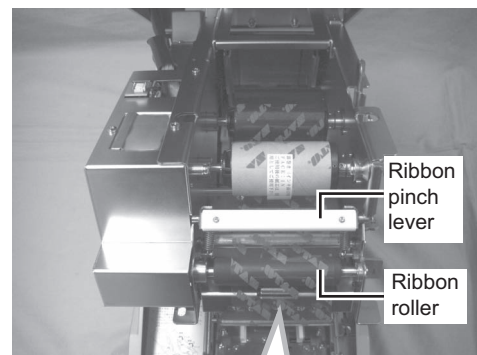

10. Turn the rewind shaft bearing several times in the direction of arrow to wind the ribbon until the ink portion of the ribbon comes around the ribbon roller.

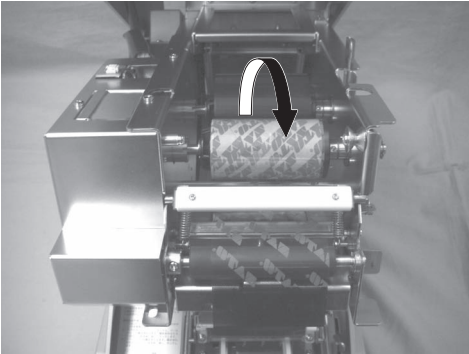

11. Lift down the ribbon pinch lever back to the ribbon roller position.

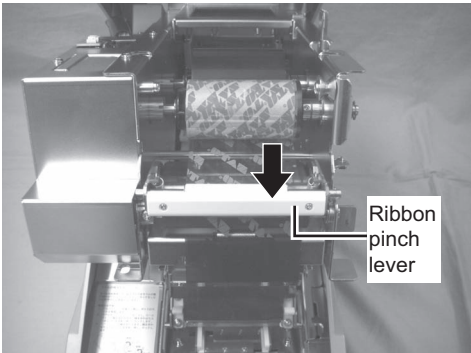

12. Lift up the ribbon unit and remount the pinch roller unit. Latch the pinch roller unit until you hear a "tick" sound.

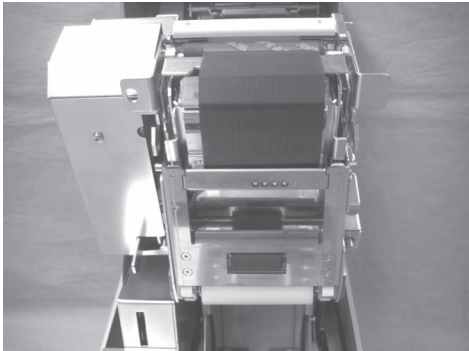
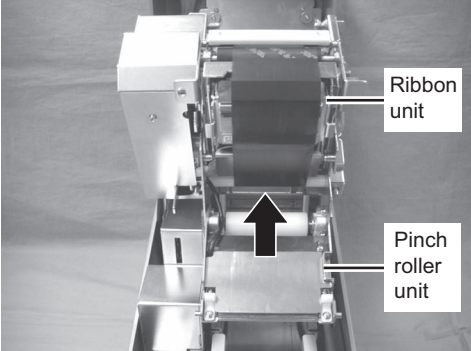

## 2.4 LOADING THE CARBON RIBBON (cont'd)

---

**13.** Remount the ribbon unit by pushing it towards the top cover until you hear a “tick” sound.



**14.** Close the top cover.

After loading the media and the carbon ribbon, close the main cover, turn on the printer and do a test print to check that the media roll has been loaded properly. See **Section 3.12 Received Data Saving Mode** for instructions on how to run test print



## 2.5 REMOVING THE CARBON RIBBON

After the carbon ribbon has used up to the end of the roll, remove the wound-up carbon ribbon from the printer.

### **Caution**

- When replacing carbon ribbon, bear in mind that the print head and its surrounding area remain hot. Keep your fingers away from these areas to prevent injury.
- Avoid touching even the edge of the print head with your bare hands.

1. With the power supply is off, lift up the **top cover** and release the ribbon unit by pressing the **ribbon lever**.

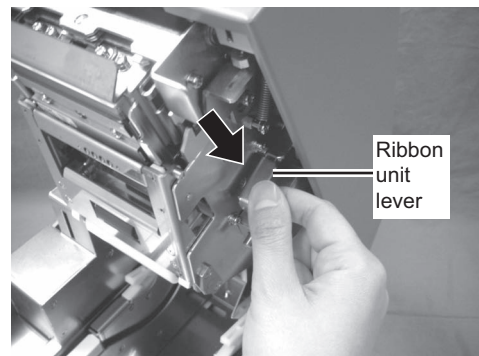

2. Hold two corners of the pinch roller unit to unlatch it.

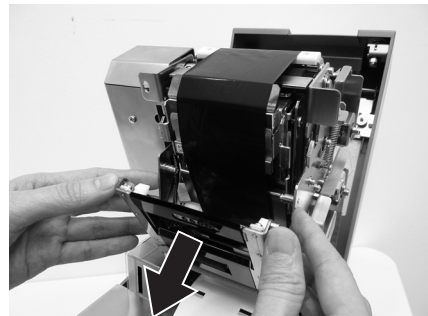

3. Lift up the ribbon pinch lever.

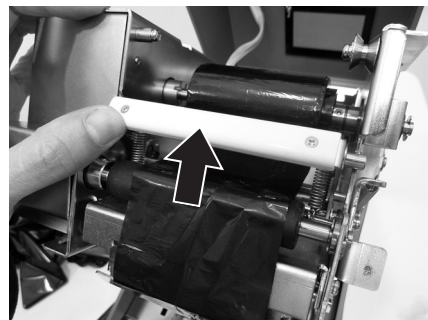

## 2.5 REMOVING THE CARBON RIBBON (cont'd)

---

4. Push the wound-up carbon ribbon to the right side of the rewind shaft bearing to remove the ribbon rewind shaft assembly.

**Caution:**

Be careful when removing the carbon ribbon, your hands may get dirty while handling it.

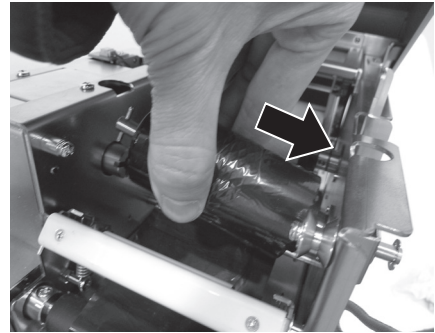

5. Remove the empty core from the ribbon supply shaft in the same manner.

**Note:**

Don't dispose of the empty ribbon core after removing it from the ribbon supply shaft. Instead, transfer it to the ribbon rewind shaft so that used ribbon can be wound around it after a new ribbon roll has been loaded.



## 2.6 BASIC CONNECTIONS

This section explains the power cable and interface cable connection procedures.

### 2.6.1 Connecting the Interface board

HR2 Series printers are equipped with three different types of standard interface to perform data communication with the host. These are described as follows.

- USB interface
- LAN interface
- RS-232C (High-speed) interface

Connect interface cable from the printer to the host computer. Use the cable that is compatible with the standard of the interface board as stated in Section 7: Interface Specifications. Make sure the cable is correctly oriented before you insert it.

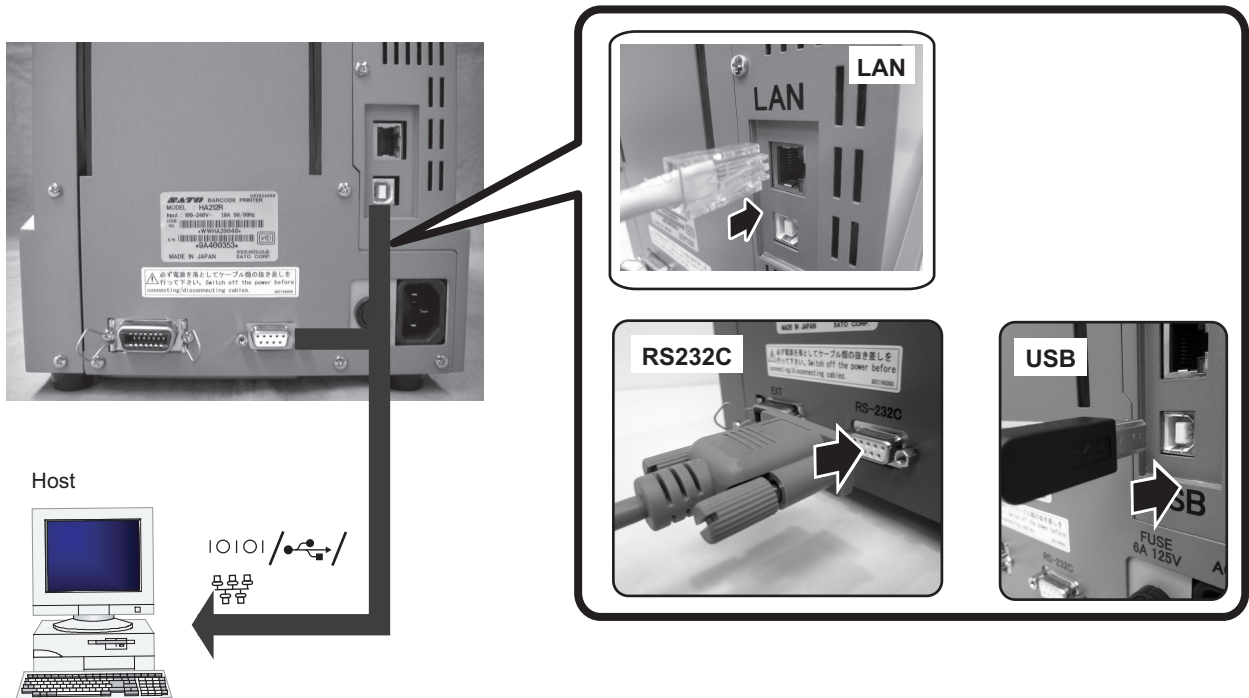

## 2.6 BASIC CONNECTIONS (cont'd)

### 2.6.2 To Configure the Connected Interface

After connection, you need to set the configuration of the connected interface in the **INTERFACE MODE** menu of the printer. Please refer to **Section 3.7 Interface Mode** for details on setting Interface Mode.

In Interface mode, you will need to determine which interface is set as Data Port and which is set as Sub Port. An overview of each port is shown as below.

#### Data Port

When the interface is set to the Data Port, it can receive various SBPL commands and it can execute print operations.

Data port selection: USB, LAN, RS-232C

\* The interface which already set for SUB PORT is not able to select.

#### Sub Port

This port is for monitoring printer status and connecting to external devices.

Sub Port selection: NONE, USB, LAN, RS-232C

\* The interface which already set for DATA PORT is not able to select.

#### Note:

Data Port and Sub Port cannot use the same interface at the same time.

### 2.6.3 Interface Combination

The interface combinations that can be used for Data Port and Sub Port are as follows.

		Data port		
		RS-232C	USB	LAN
Sub Port	RS-232C	x	o	o
	USB	o	x	o
	LAN	o	o	x

[o: configurable, x: not configurable]

The following table shows the combination of interface with keypad and the port type.

Condition Interface	Keypad connection		Keypad disconnection	
	Data Port	Sub Port	Data Port	Sub Port
RS-232C	x	x	o	o
USB	x	o	o	o
LAN	x	o	o	o
NONE	x	x	x	o

[o: configurable, x: not configurable]

## 2.6 BASIC CONNECTIONS (cont'd)

### Notes

- Do not select the same interface for the data and sub ports.
- RS-232C and Keypad can't be used at the same time as they use a common connector.  
When Keypad is connected, the data port isn't available. Only the sub port is available, but SBPL commands will be disabled.  
When the interface other than [RS-232C] is set to the data port, the interface selection changes to [RS-232C]. If [RS-232C] is set to the sub port, the interface selection changes to [NONE].

### 2.6.4 Connecting the Power Cable



#### Warning

- Be sure to connect the ground wire. Failure to do so may cause an electric shock.
- Do not operate the power switch or insert/remove the power cable while your hands are wet. Doing so may cause an electric shock.



#### Caution

The power cable provided with this printer are for use with this printer only. They cannot be used with other electrical devices.

1. Connect the power cable to the **AC IN** power terminal on the rear panel of the printer.  
Make sure that the connector is correctly oriented.  
Secure the printer with one hand, and insert the connector firmly.



2. Insert the power plug into a AC power outlet.  
Make sure that the AC voltage of your region is within the range of AC 100 to 240V, 50/60 Hz.  
A 3-pin plug is attached to the power cord provided with your printer. One of these pins is the ground wire.  
If the power outlet that you plan to use is a 3-pin type, simply insert the power plug as is.

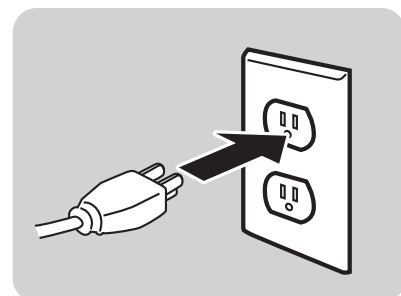

\* The shape of the power plug may vary depending on the location where the printer was purchased.

## 2.6 BASIC CONNECTIONS (cont'd)

### 2.6.5 Turning On the Power



#### Warning

Do not operate the power switch or insert/remove the power cable while your hands are wet. Doing so may cause an electric shock.

Turn on the power switch located on the front, bottom left corner of the printer.

Press the side of the switch marked "I".

- When you turn on the power, the printer start-up and detect for the loaded media and ribbon. If the media are correctly loaded, "ONLINE" appears on the display.
- If the media and carbon ribbon are not loaded or properly loaded, the printer will prompt an error message. Load the media and carbon (refer to **Section 2.3 Loading Media** and **Section 2.4 Loading the Carbon Ribbon**) and then press **LINE** button.

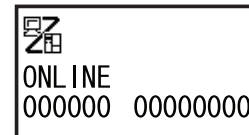
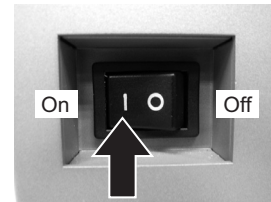

### 2.6.6 Turning Off the Power

When you have completed the printing job, turn the printer off.

1. Press the **LINE** button to put the printer offline.  
Be sure to confirm that the printer is in the offline status before turning it off.  
If there is any printed media remaining in the printer, press **FEED** button to forward feed the media and cut it off.
2. Turn off the power switch on the printer's operation panel.  
Press the side of the switch marked "O".

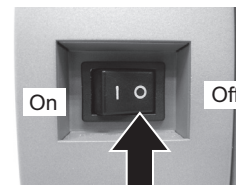
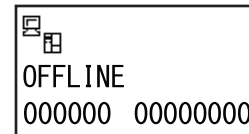

## 2.7 CONNECTIONS OF OPTIONAL ACCESSORIES

### 2.7.1 Connecting optional Keypad

The optional keypad can be connected to the HR2 Series printer with the **RS-232C** terminal, thus providing a stand-alone function.

1. Make sure that power cable is not connected to the printer.
2. Connect the cable from the optional Keypad device to the **RS-232C** terminal at the rear of the printer.

**Note:**

Make sure the connector is correctly oriented. Secure the printer with one hand, and insert the connector firmly.

3. Set the printer for use with the connected device. Refer to **Section 3.7 Interface Mode** and perform the procedures to set the **Keypad CONNECT** to **ENABLE**.
4. Then set the **DATA PORT** as **RS-232C** and the **SUB PORT** as **NONE**.



**Notes:**

- Keypad needs to connect to RS-232C connector, and RS-232C interface are not able to use as data port at the same time.
- You cannot use data port when Keypad is connected and the setting of Keypad connection is valid. (You can use Sub Port, but SBPL command is not effective.)

### 2.7.2 Installing optional Memory storage

The optional SD card can be used for uploading and downloading the data (graphics, extended character) registered in the printer and the printer firmware.

**Installing optional SD card**

You can connect the optional SD card to the SD card slot located as shown in the picture.

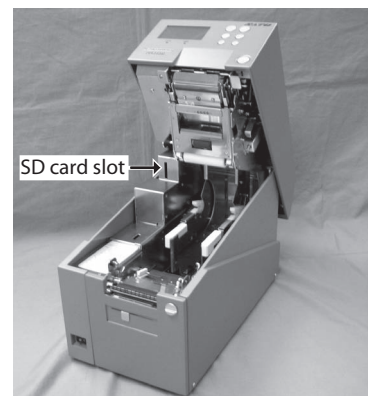

## 2.7 CONNECTIONS OF OPTIONAL ACCESSORIES (cont'd)

---

1. Insert the SD card with the orientation as shown in the picture.
2. To seat the SD card in the slot, press it in until it makes a slight clicking sound and it is completely inside the printer.

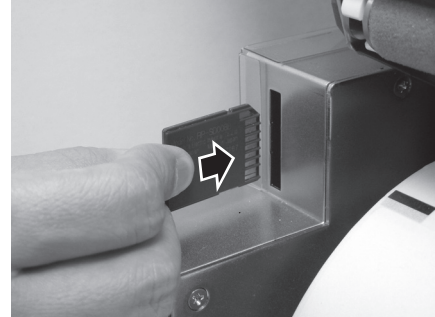

3. To remove the SD card from the printer, it is best to switch off the printer. Then, with your finger, press the card edge a slight amount to release the card from the slot. The slot will immediately release the card.

**Note:**

Do not remove the SD card while the printer is accessing the data in the SD card. Doing so may result in data corruption.

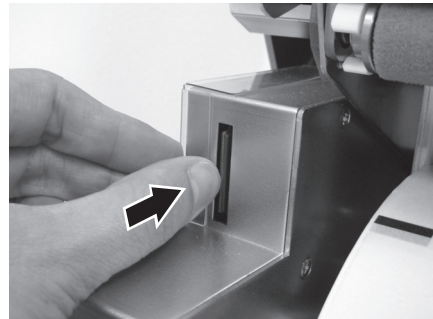

2.7 CONNECTIONS OF OPTIONAL ACCESSORIES (cont'd)

Folder Configuration

The following is the folder architecture inside the SD card to be used for the printer.

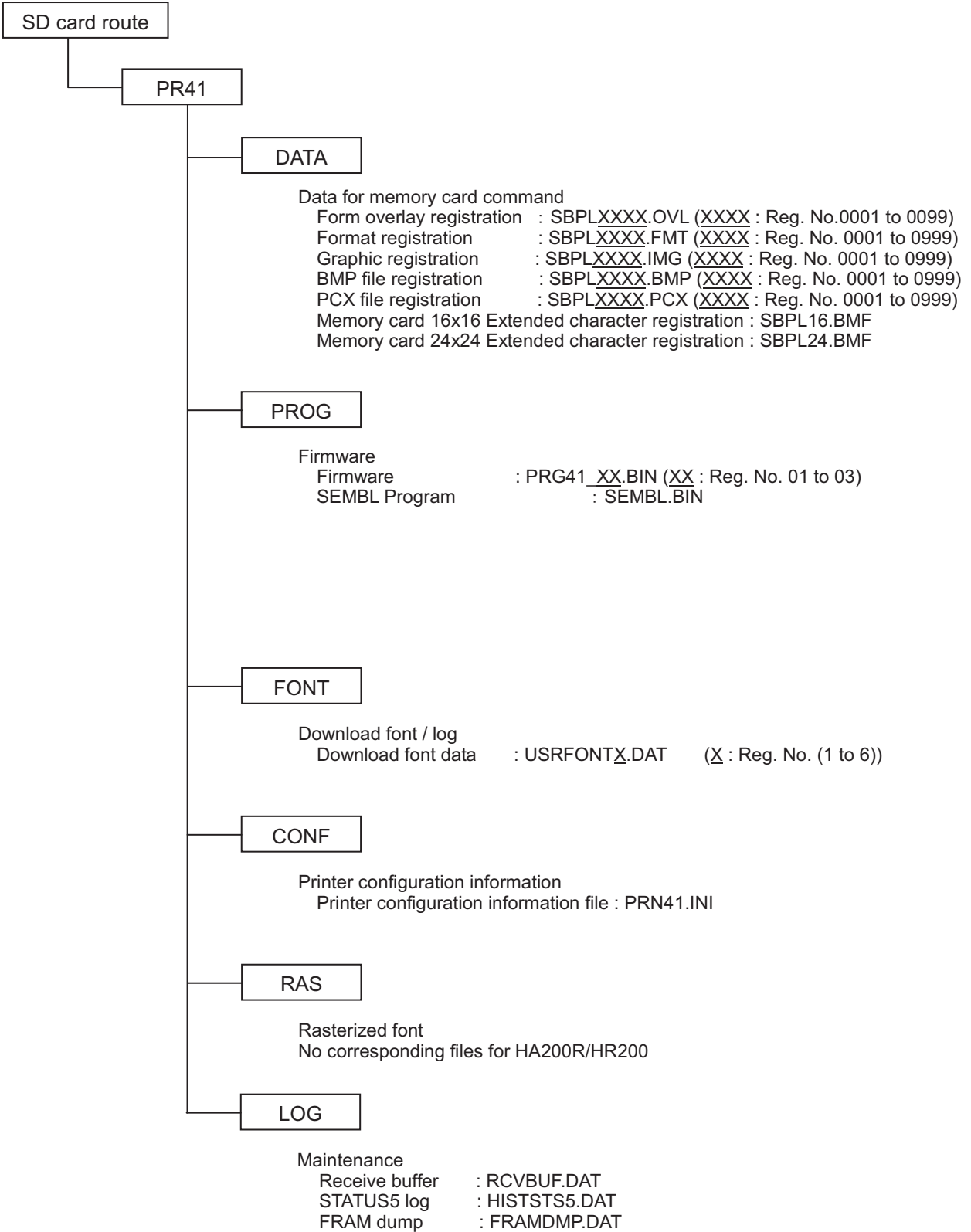

## 2.7 CONNECTIONS OF OPTIONAL ACCESSORIES (cont'd)

---

### Notes:

- In the folder architecture, the folders under [PR41] can be created by formatting the SD card in Memory Card Mode.
  - Be sure to format the SD card in Memory Card Mode. If formatting the SD card by Windows or other methods, you may not be able to save or view the data.
  - Attempting to download or upload the data without formatting the SD card properly will cause an error preliminarily.
- Do not change file name and folder names under the folder [PR41].
- Inside the folders [PROG] and [FONT], if you save files other than released (or uploaded) firmware and font files, the printer motion after download behavior or download may be unstable. Be sure not to save any files unless they are released (or uploaded).
- Do not remove the SD card while the printer is accessing the SD card. Doing so may result in data corruption.
- When you save the data to the SD card by using the save-related SBPL commands, its file creation date will be the firmware release date.

## 2.8 LCD POWER SAVING MODE

---

The LCD backlight is turned off for power saving when the printer is not operated for a specified period of time. The time to turn off the LCD backlight can be set via the LCD POWER SAVING MODE SETTING screen in the Advanced Mode. Please refer to **Section 3.10 Advanced Mode** for instructions.

### 2.8.1 Turning off the LCD Backlight

At the following conditions, the LCD backlight is turned off when the time specified on the LCD POWER SAVING MODE SETTING screen has elapsed. In this function, only the LCD backlight is turned off and the on-screen message remains the same.

- The printer has not received the print data (ESC+A~ESC+Z) in various interfaces.
  - \* Omitting status return request and cancel request of each protocol and/or incorrect data.
- No button is pressed.
- The printer is not in error state.
- The printer is neither printing nor feeding paper.
- The printer is in online state, offline state, HEX dump mode or SEMBL mode.
  - \* This function is disabled in the Download Mode.

### 2.8.2 Turning on the LCD Backlight

Following one of the instructions below will turn on the LCD backlight again.

- The printer received the print data from various interface boards.
  - \* Omitting status return request and cancel request of each protocol and/or incorrect data.
- Some buttons are pressed.
- Printer error such as "Cover open" occurred.
- The printer started printing operation.

Pressing any button while the LCD backlight is off will turn on the LCD backlight only.

(The printer does not go offline by pressing the **LINE** button when the LCD backlight is off in online state.)



# 3

## OPERATION AND CONFIGURATION

---

Before using the printer, it is best to read this manual thoroughly first. Otherwise, you may disturb default settings around which the instructional procedures in this manual are based upon.

The printer may be manually configured via the **LINE**, **FEED**, **+**, **-**, **<** and **>** buttons with the LCD display on the operator panel of printer. All of the printer's buttons are used either singularly, or in conjunction, to perform configuration activities.

Many of these settings can also be controlled via software commands and in case of conflict between software and control panel settings, the printer will always use the last valid setting. If you load a label job that includes software settings and then enter a new setting via the LCD panel, the manually set values will be used by the printer. If you set the values manually and then download a job with software settings, the software settings will be used.

### 3.1 OPERATOR PANEL

The operator panel locate on the front consist of two LED indicators, six momentary contact buttons and one LCD display.

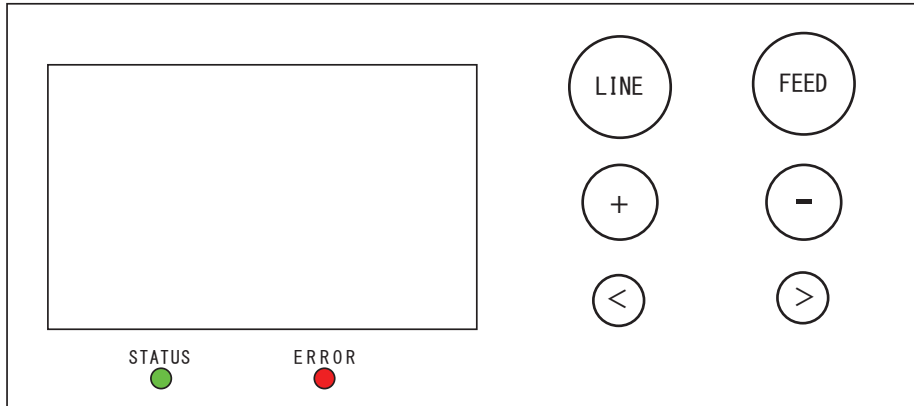

- **LED indicators**

When the printer is in normal mode, these two indicators notify the user of various status conditions:

LED Indicator	Color	Functions
STATUS	Green	Illuminates when printer is ready to receive data or is in printing mode (Online). Light is off when the printer is in offline or error state. Blinks when the printer detects buffer near full.
ERROR	Red	Illuminates or blinks when detecting printer error.

- **LINE** button

Pressing this button toggles the printer between the online and offline mode. When the printer is online, it is ready to receive data from host. This button acts as a pause during a print job by taking the printer offline.

This button also function as returning to the previous item during various printer setting with the LCD display.

When performing long press during various printer setting, the screen will go back to [Mode Menu] directly.

- **FEED** button

Pressing this button feeds one blank label through the printer.

This button also function as determining the setting during various printer setting with the LCD display.

- **+** button

Incrementing setting value in various setting modes, or moving cursor up/down in menus.

Makes the LCD display darker in Online state.

- **-** button

Decrementing setting value in various setting modes, or moving cursor up/down in menus.

Makes the LCD display lighter in Online state.

- **<, >** arrow buttons

These cause the cursor to shift left and right for selecting item on the screen in various setting modes.

### 3.1 OPERATOR PANEL (Cont'd)

---







- **LCD Display**

Up to five icons and two lines of alphanumeric text can appear on the LCD display to indicate the current printer status.







The same area can also display two lines of alphanumeric text during various setting modes.

#### List of Icons

[Mode display]

No	Icon	Description
1		Displayed when printer is in online state
2		Displayed when printer is in offline state
3		Displayed when printer is in Test Print Mode and HEX Dump Print Mode
4		Displayed when printer is in SEMBL Mode
5		Displayed when printer is in Download Mode
6		Displayed when Keypad is connected to printer
7		Displayed when printer is in Upload Mode















[Mode selection screen]

No	Icon	Description
1		Changing to Normal Mode
2		Changing to User Mode
3		Changing to Interface Mode
4		Changing to Cartridge Mode (Memory Card Mode)
5		Changing to SEMBL Mode
6		Changing to Advanced Mode
7		Changing to HEX Dump Print Mode



### 3.1 OPERATOR PANEL (Cont'd)

#### List of Icons (Cont'd)

[Error-related]

No	Icon	Description
1		Displayed when detecting Label End
2		Displayed when detecting Ribbon End
3		Displayed when detecting Sensor Error
4		Displayed when detecting Top cover open and head lift error
5		Displayed when detecting electrical disconnection of print head
6		Displayed when detecting Communication Error
7		Displayed when detecting Receive Buffer Over
8		Displayed when detecting Item No. Error or BCC Error
9		Displayed when having write failure to main ROM or when detecting Kanji ROM error
10		Displayed when detecting a command error due to the message display function of command error
11		Displayed when detecting an improper download data
12		Displayed when having a memory access error or when running out of memory space
13		Displayed when detecting printer error other than the above
14		Error number corresponding to each error

[Warning-related]

No	Icon	Description
1		Displayed when detecting Command Error
2		Displayed when detecting Receive Buffer Near Full
3		Displayed when detecting electrical disconnection of print head

## 3.2 OPERATING MODES

---

The operating status of this printer can be set within one of the following modes:

1. Normal mode (including ONLINE/OFFLINE modes)
2. Adjustment screen
3. Cancel Print Job mode
4. Printer Setting mode:
  - User mode
  - Interface mode
  - Cartridge mode (Memory Card mode)
  - SEMBL mode
  - Advanced Mode
  - Hex Dump mode
5. Test Print mode
6. Default Setting mode
7. Maintenance mode
8. Service mode
9. Download mode
10. Upload mode

The various modes are accessed by pressing the **LINE** button, **FEED** button, **+** button, **-** button and **<**, **>** arrow buttons while the printer is Off, On or with certain printer settings in force.

### 3.2 OPERATING MODES (Cont'd)

The following flow chart provides a clear summary of all the modes and their access methods.

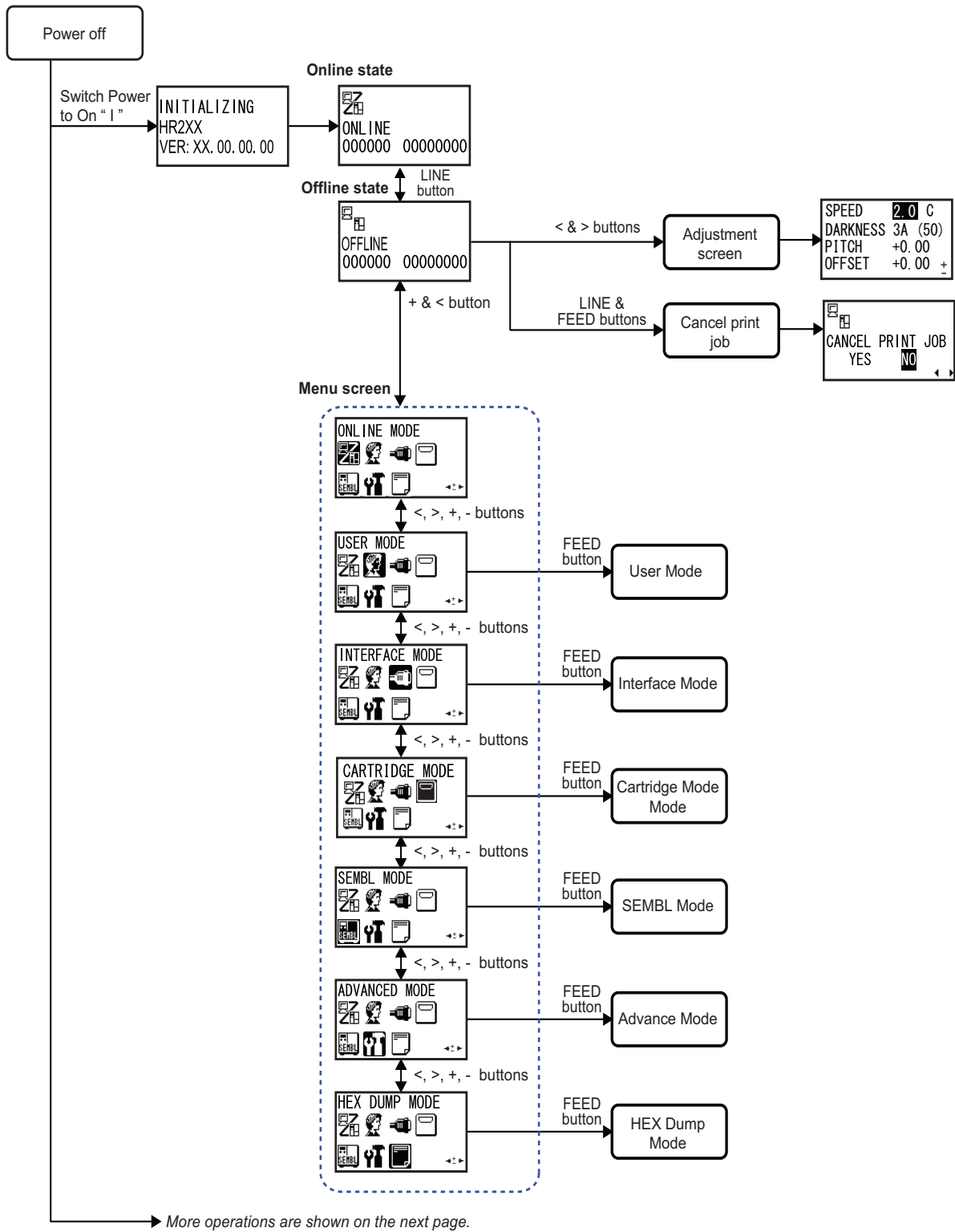

3.2 OPERATING MODES (Cont'd)

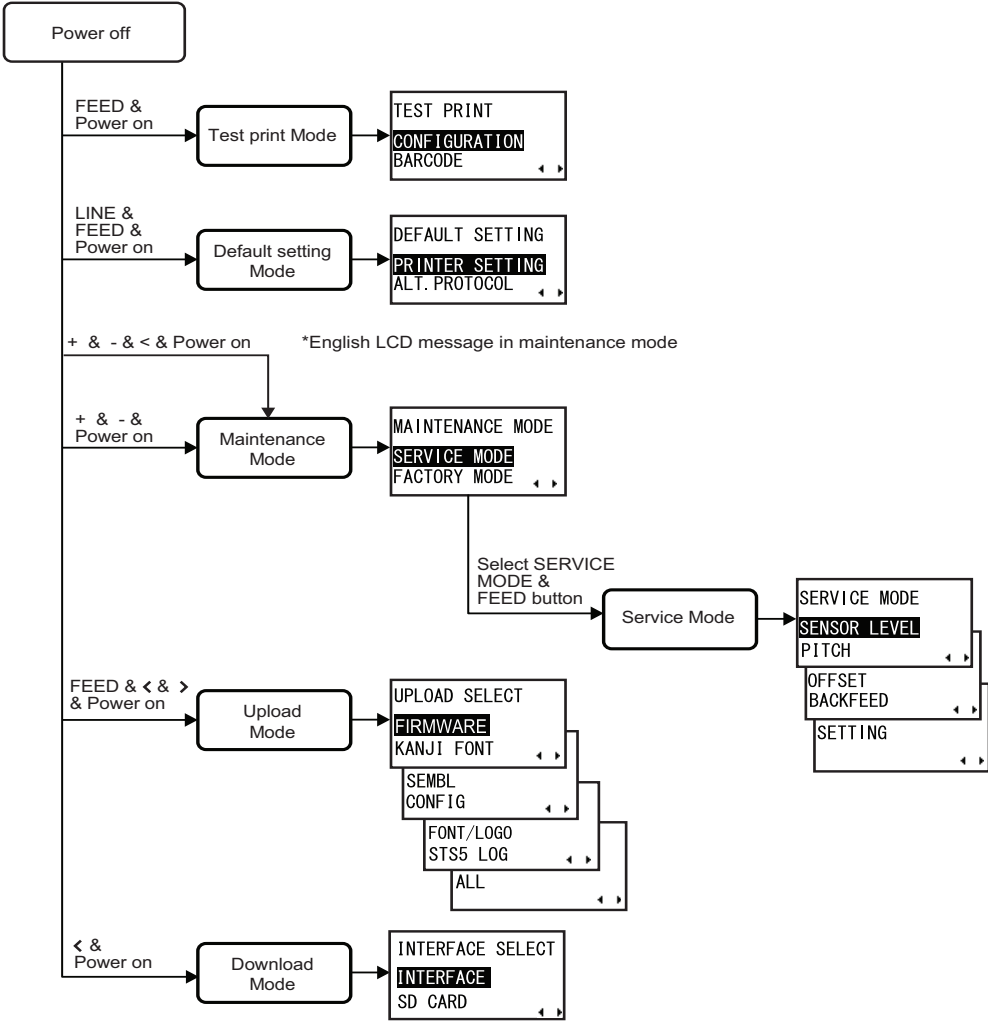

### 3.3 ONLINE AND OFFLINE MODES

The general and basic operation of the HR2 series printer is via the Normal mode, which consists of the ONLINE and OFFLINE modes.

#### 3.3.1 Online Mode

Pressing the **LINE** button causes the printer to go ONLINE or OFFLINE alternately.

When the printer is ONLINE, the following activities will be possible:

- The printer is ready to receive print data from the computer or other connected devices
- The printer is ready to start printing

The number displayed on the bottom line of LCD panel shows the media quantity status. As soon as a print job is received, the display on the bottom will indicate the number of labels to be printed. When the label job begins to print, this display will indicate the remaining number (countdown) of labels to be printed.

Display method can be changed on the TOTAL QTY DISPLAY screen in the service mode, refer to **Section 3.16.5 Overview of Setting menu in Service Mode** for details.

When the TOTAL QTY DISPLAY screen is set as YES, the number displayed on the bottom line of LCD panel shows the remaining number (countdown) of labels to be printed on the left and the total quantity on the right (Total print quantity from the time the printer is turned on).

When TOTAL QTY DISPLAY is set as NO

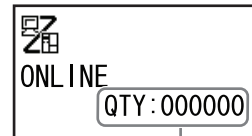

remaining number (countdown) of labels to be printed

When TOTAL QTY DISPLAY is set as YES (Default)

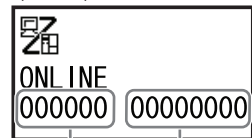

remaining number (countdown) of labels to be printed      total printed quantity

#### 3.3.2 Offline Mode

When the printer is ONLINE, pressing the **LINE** button once will cause the printer to go OFFLINE. Any printing job will be PAUSE once the printer is brought OFFLINE.

When the printer is OFFLINE, the activities for ONLINE mode are no longer possible, but the following activities will be possible:

- The printer can feed a blank label when you press the **FEED** button.
- The printer can be switched to CANCEL PRINT JOB modes when you press the **LINE** and **FEED** button simultaneously.
- The printer goes to Adjustment screen when you press the **<** and **>** **arrow** buttons simultaneously.
- In OFFLINE mode, press the **+** and **<** buttons simultaneously to access the icon-based printer settings menu. Using the arrow buttons, you can access the ONLINE mode, USER mode, INTERFACE mode, SEMBL mode, ADVANCED mode, HEX DUMP mode and CARTRIDGE mode from here. These modes will be discussed in subsequent sections.

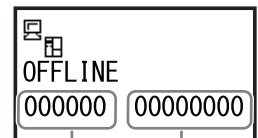

remaining number (countdown) of labels to be printed      total printed quantity

#### 3.3.3 To Adjust the Screen Contrast

In Normal mode (ONLINE or OFFLINE), press the **+/-** buttons repeatedly to adjust the contrast.

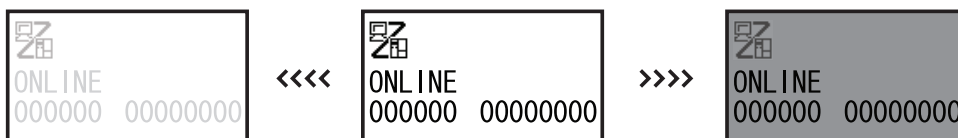





**3.4 ADJUSTMENT SCREEN (Cont'd)**

Menu	Description
<pre> SPEED  2.0 C DARKNESS 3A (50) PITCH  +0.00 OFFSET  +0.00 ±                     </pre>	<p>Adjust the print speed.                      Setting range is between 1.0 and 4.0IPS, and the initial value is 2.0IPS.                      This setting reflects the setting of PRINT SPEED screen in USER MODE.</p>
<pre> SPEED  2.0 C DARKNESS 3A (50) PITCH  +0.00 OFFSET  +0.00 ±                     </pre>	<p>Command priority setting.                      C: Enables Command priority setting.                      I: Disables Command priority setting.                      The default setting is "C".                      This setting reflects the setting PRIORITY SETTING screen in SERVICE MODE.</p>
<pre> SPEED  2.0 C DARKNESS 3A (50) PITCH  +0.00 OFFSET  +0.00 ±                     </pre> <pre> SPEED  2.0 C DARKNESS 3A (50) PITCH  +0.00 OFFSET  +0.00 ±                     </pre>	<p>Adjust the print darkness of the print-out.                      Setting range is 1A, 2A, 3A, 4A, 5A, 1B, 2B, 3B, 4B, 5B. (1A is the lightest while 5B is the darkest. Default is "3A")                      This setting reflects the setting of PRINT DARKNESS screen in USER MODE and the DARKNESS RANGE screen in ADVANCED MODE.</p> <p>Setting value of the selected range is between 00 and 99, and the initial value is 50. (00 is the lightest while 99 is the darkest.)                      After setting the value of print darkness, press <b>FEED</b> button will save the value and proceed to PITCH position setting if there is no remaining label to be printed. (QTY=0)                      Otherwise, the printer will return to SPEED setting screen. (QTY≠0)</p> <p><b>Note:</b>                      It is not advisable to set the print darkness to the higher position as a darker print-out requires the print head to operate in a higher temperature. Operating in high temperature may damage the print head in a long run.</p>
<pre> SPEED  2.0 C DARKNESS 3A (50) PITCH  +0.00 OFFSET  +0.00 ±                     </pre>	<p>Adjusts the print position or reference point where the printings begins vertically, relative to the leading edge of each media.                      Setting value is adjustable by 0.25mm (0.01") regardless of print resolution.                      Setting range is ±3.75mm (±0.15") and the initial value is +0.00mm.</p>
<pre> SPEED  2.0 C DARKNESS 3A (50) PITCH  +0.00 OFFSET  +0.00 ±                     </pre>	<p>Adjust the stop position of each media after printing.                      Setting value is adjustable by 0.25mm (0.01") regardless of print resolution.                      Setting range is ±3.75mm (±0.15") and the initial value is +0.00mm.</p>

### 3.5 CANCEL PRINT JOB MODE

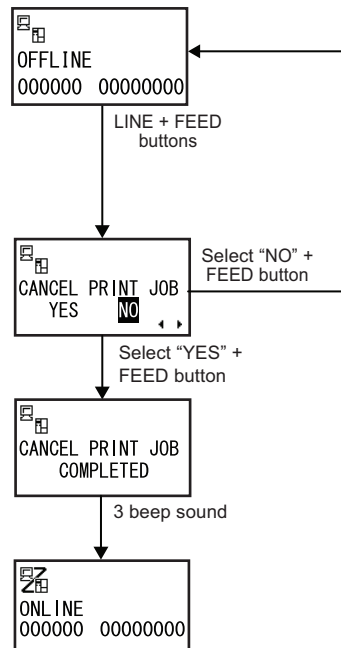

1. When the printer is OFFLINE, pressing both the **LINE** and **FEED** buttons at the same time will switch the printer to CANCEL PRINT JOB mode. The menu for canceling the print job then appears.
2. Press **<**, **>** **arrow** buttons to switch between the selection, YES or NO. The highlight on display indicates the selected option. The default setting is NO.  
If the printer has a print job in memory, selecting YES will cause the job to be cleared.

**Notes:**

- Be sure you want to cancel the print job before selecting YES as the job cannot be recovered and will have to re-transmit to the printer.
  - Select **NO** press **FEED** button to exit the CANCEL PRINT JOB mode without clearing the print data.
3. Press **FEED** button to activate the selection.  
If YES is selected, the message CANCEL PRINT JOB COMPLETED will display with 3 beeps sound and then goes to ONLINE mode. All the print jobs were cleared from memory.

### 3.6 USER MODE

The following settings are available in the User Mode.

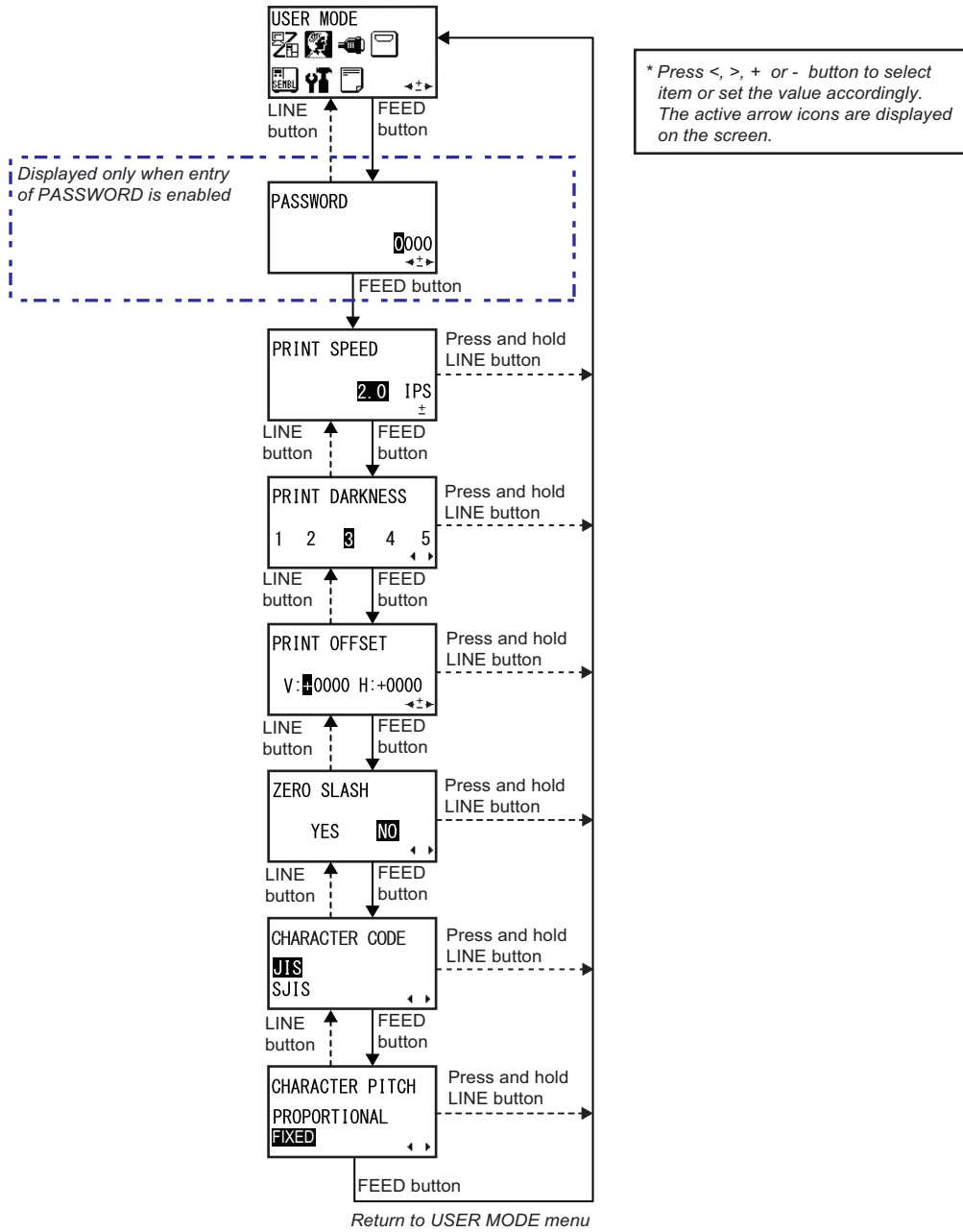

### 3.6 USER MODE (Cont'd)

1. During OFFLINE mode, press + and < button simultaneously to display the operational icon menu. Press <, >, + or - buttons to select USER MODE.
2. When USER MODE screen is displayed, press the **FEED** button to enter to User mode for adjustment.

**Note:**



PASSWORD may prompt on the display if SET PASSWORD is set to ON in the Service mode. Please refer to **Section 3.16.5 Overview of Setting menu in Service Mode** for details in password inputting.

3. PRINT SPEED is first displayed. Press the **FEED** button repeatedly will switch to the next setting options as shown above. To return to the previous setting option, press **LINE** button.
4. When the desired setting option is displayed, press <, >, + or - buttons to select the item or to set the value and then press **FEED** button to save the setting. To return to USER MODE screen, press and hold **LINE** button.

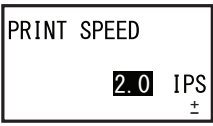
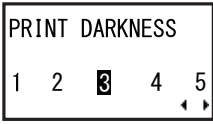
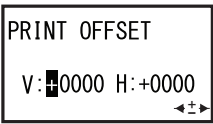
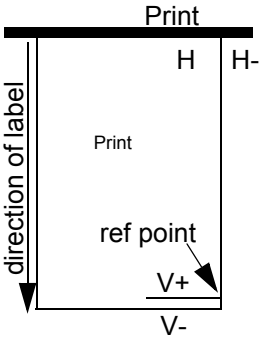
You may wish to print a test print after completing the adjustments to ensure they are correct. Refer to **Section 3.13 Test Print Mode** for details.

USER MODE							
Menu	Description						
	<p>Adjusts the print speed that does not compromise print quality. Setting range is between 1.0 and 4.0 IPS (inches per second) with a increment of 0.5 IPS cyclically. The initial value is 2.0 IPS.</p>						
	<p>This setting adjusts the print darkness of the print-out with reference to the setting of the DARKNESS in Adjustment screen. Setting value can be set from 1 (lightest) to 5 (darkest). The default setting is 3.</p>						
 	<p>Print Position Offset—which refers to the vertical and horizontal shifting of the entire print area, relative to the start position of printing (V=0, H=0), defined by default to be the bottom right hand corner of the media.</p> <p>The V setting is for the Vertical print offset. A positive (+) offset means the printing is shifted towards the print head; a negative (-) offset means shifting away from the print head. If the PITCH POSITION setting has been used to offset the vertical start position, then all Vertical offset adjustments are made relative to that start position.</p> <p>The H setting is for the Horizontal print offset. The + or - prefix determines whether the offset is to the left or to the right of the reference point.</p> <p>Setting value is indicated by dot, and the initial value, regardless of print resolution, is V:+0000 H:+0000.</p> <p>Setting range differs by print resolution.</p> <table border="0"> <tr> <td>[12dots/mm]</td> <td>:V:±0 to 2400</td> <td>H:±0 to 672</td> </tr> <tr> <td>[24dots/mm]</td> <td>:V:±0 to 4800</td> <td>H:±0 to 1344</td> </tr> </table>	[12dots/mm]	:V:±0 to 2400	H:±0 to 672	[24dots/mm]	:V:±0 to 4800	H:±0 to 1344
[12dots/mm]	:V:±0 to 2400	H:±0 to 672					
[24dots/mm]	:V:±0 to 4800	H:±0 to 1344					

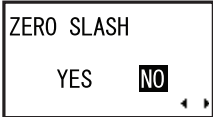
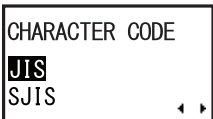
### 3.6 USER MODE (Cont'd)

USER MODE	
Menu	Description
 <p>ZERO SLASH YES    <b>NO</b></p>	<p>You can use this setting to determine whether zeroes are printed with a slash across them or not. The zero slash can be set to either 0 or Ø.</p> <p>If YES, [0] will be accompanied by a slash. If NO, no slash will appear. The initial value is NO.</p> <p>* Slash zero (zero has a slash through it) is available in the following fonts: U, S, M, WB, WL, XU, XS, XM, XB, XL, Outline font</p>
 <p>CHARACTER CODE <b>JIS</b> SJIS</p>	<p>Allows you to select character code from the following:</p> <p>“JIS”: Uses JIS for Kanji code. “SJIS”: Uses Shift JIS for Kanji code. “Unicode”: Used Unicode for Kanji code. The default is “JIS”.</p>
 <p>CHARACTER PITCH PROPORTIONAL <b>FIXED</b></p>	<p>This setting determines whether the space surrounding each text character is of a fixed width, or whether that space is to be varied to be visually more pleasant and proportional.</p> <p>If selecting PROPORTIONAL, data will be printed without character spacing. If selecting FIXED, data will be printed with fixed character spacing. The initial value is FIXED.</p>

### 3.7 INTERFACE MODE

In this mode, you can set various parameters governing the use of interface cards.

#### 3.7.1 Overview of Interface Mode Configurations

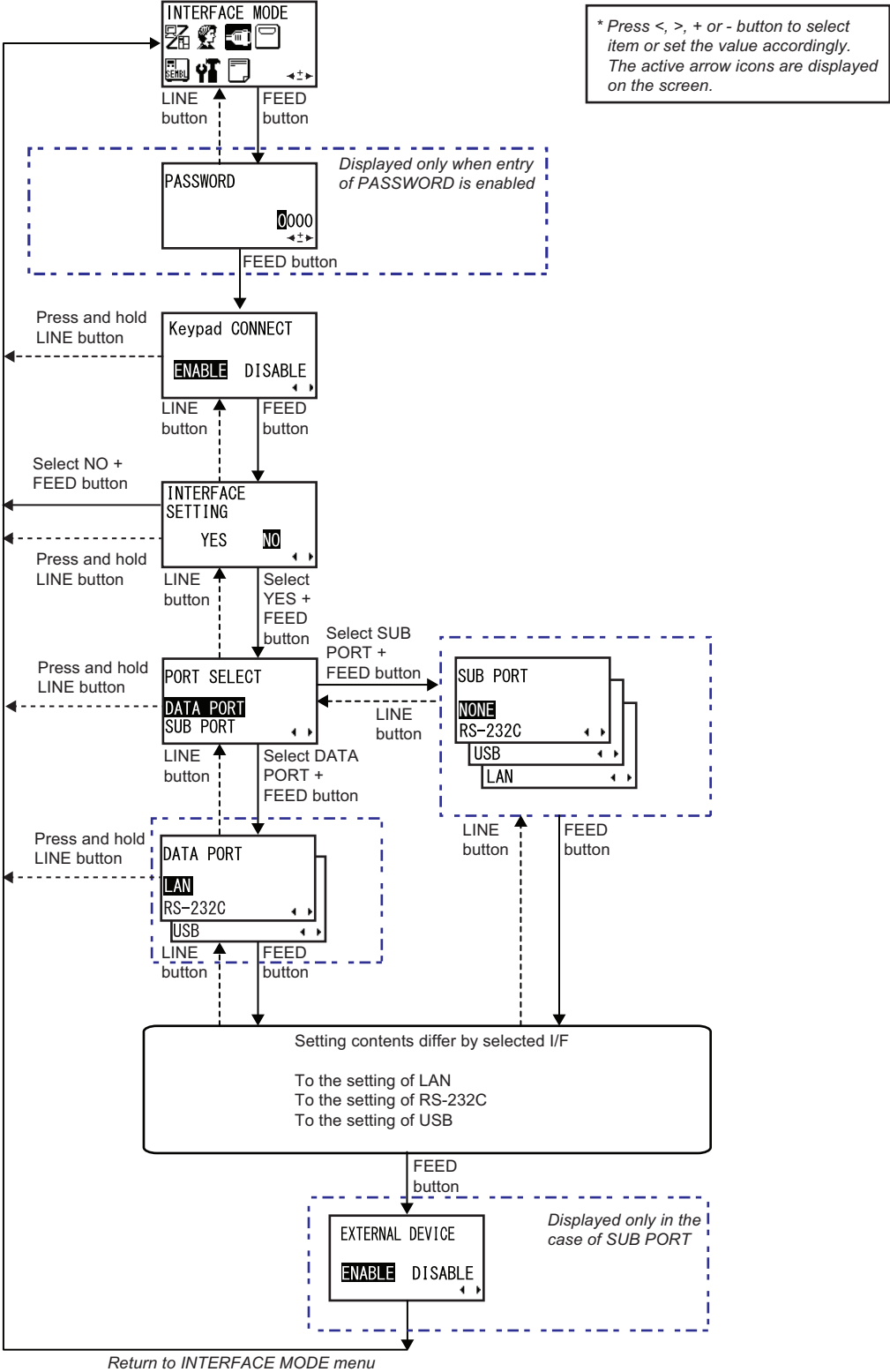



### 3.7 INTERFACE MODE (Cont'd)

1. During OFFLINE mode, press + and < button simultaneously to display the operational icon menu. Press <, >, + or - buttons to select INTERFACE MODE.
2. When INTERFACE MODE is displayed, press the **FEED** button to enter to Interface mode for adjustment.

**Note:**

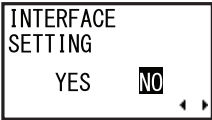

PASSWORD may prompt on the display if SET PASSWORD is set to ON in the Service mode. Please refer to **Section 3.16.5 Overview of Setting menu in Service Mode** for details in password inputting.

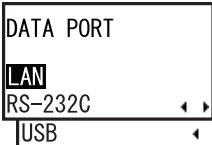
3. Keypad CONNECT is first displayed. Press the **FEED** button repeatedly will switch to the next setting options as shown above. To return to the previous setting option, press **LINE** button. To return to INTERFACE MODE screen, press and hold **LINE** button.
4. When the desired setting option is displayed, press <, >, + or - buttons to select the item or to set the value and then press **FEED** button to save the setting.

INTERFACE MODE	
Menu	Description
 <p>Keypad CONNECT ENABLE DISABLE</p>	<p>This screen shows the connection setting of input device (Keypad).</p> <p><b>ENABLE:</b> If the input device is connected, print data from the device will be valid. If the device is disconnected, print data received from the PC will be valid. * The data received from the PC becomes invalid while the input device is connected.</p> <p><b>DISABLE:</b> Only the print data received from the PC becomes valid. * The data received from the input device becomes invalid.</p> <p>The initial cursor position is at ENABLE. Connection status of input device can be checked by the status icon displayed in the Normal Mode (ONLINE/ OFFLINE). <b>Note:</b> Changed settings will be in effect from the next power on.</p>
 <p>INTERFACE SETTING YES NO</p>	<p>This is a confirmation screen for setting the connected interface configurations. If YES, it goes to the PORT SELECT screen. If NO, it returns to INTERFACE MODE menu. The initial cursor position is at NO.</p>
 <p>PORT SELECT DATA PORT SUB PORT</p>	<p>This screen allows user to select the port used for the connected interface. Either DATA PORT or SUB PORT can be selected.</p> <p>DATA PORT: It can receive various SBPL commands and it can execute print operations. SUB PORT: It is for monitoring printer status and connecting to external devices. The initial cursor position is at DATA PORT.</p>
 <p>DATA PORT LAN RS-232C USB</p>	<p>Select the connected interface to be used as Data Port. One of three interfaces, LAN, RS-232C, USB can be selected. The initial cursor position is at LAN.</p> <p><b>Notes:</b></p> <ul style="list-style-type: none"> <li>•You can't select the data port when Keypad is connected to RS-232C.</li> <li>•The interface which already set for SUB PORT is not able to select.</li> </ul> <p>Restart the printer to enable the new settings.</p>

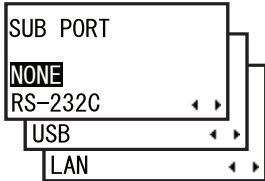

3.7 INTERFACE MODE (Cont'd)

INTERFACE MODE	
Menu	Description
	<p>Select the connected interface to be used as Sub Port. NONE, RS-232C, USB or LAN can be selected. The initial cursor position is at NONE.</p> <p><b>Notes:</b></p> <ul style="list-style-type: none"> <li>•The interface which already set for DATA PORT is not able to select. Restart the printer to enable the new settings.</li> </ul>
	<p>This screen shows the connection setting between the Sub Port and the external device.</p> <p><b>ENABLE:</b> Connecting the sub port and the external device. It's possible to import the data from the external port into the print data by the combination of an extended command.</p> <p><b>DISABLE:</b> Not connecting the sub port and the external device. It's possible to monitor the printer status.</p> <p>The initial setting is ENABLE.</p> <p><b>Note:</b> This screen is displayed only when interface (other than NONE) is selected for SUB PORT selection.</p>

### 3.7 INTERFACE MODE (Cont'd)



#### 3.7.2 Enabling Interface Card Configuration

After selecting the interface for the Data port or Sub port, the next display shows the selected interface to be configured. Refer to the following flowcharts of all the setting and LCD display menus available for LAN, RS-232C and USB interfaces.

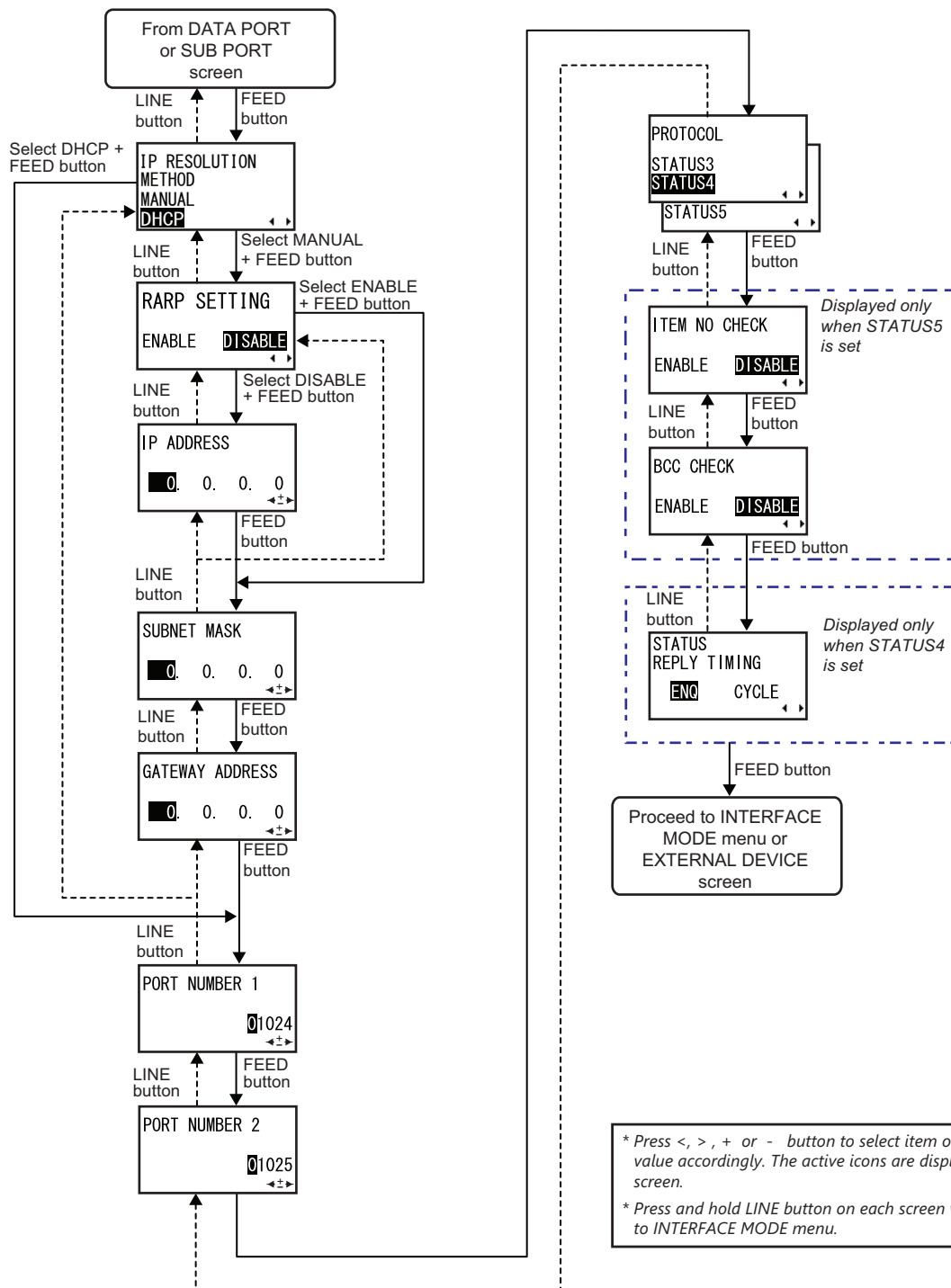

##### Setting of LAN

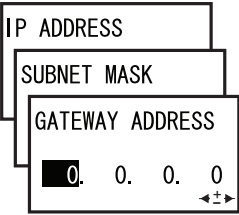
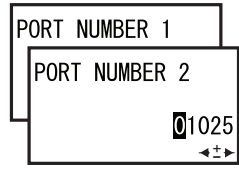

## 3.7 INTERFACE MODE (Cont'd)

LAN CONFIGURATION	
Menu	Description
 <p>IP RESOLUTION METHOD MANUAL DHCP</p>	<p>This screen allows user to select from setting of IP address manually or using DHCP to assign IP address automatically.</p> <p><b>MANUAL:</b> Perform IP addresses settings manually. Select MANUAL and press <b>FEED</b> button will proceed directly to RARP setting.</p> <p><b>DHCP:</b> Allows DHCP to assign unique IP addresses automatically. Select DHCP and press <b>FEED</b> button will continue to PORT NUMBER setting. The initial cursor position is at DHCP.</p> <p><b>Note:</b> Changed settings will be in effect from the next power on.</p>
 <p>RARP SETTING ENABLE    DISABLE</p>	<p>Set RARP (Reverse Address Resolution Protocol) function.</p> <p><b>ENABLE:</b> RARP is activate and request to learn the IP address from the server.</p> <p><b>DISABLE:</b> RARP is disabled and proceed to IP ADDRESS screen for manual input. The initial setting is DISABLE.</p> <p><b>Note:</b> Changed settings will be in effect from the next power on.</p>
 <p>IP ADDRESS SUBNET MASK GATEWAY ADDRESS 0. 0. 0. 0</p>	<p>Setting the IP address, follow by the Subnet mask and then Gateway address of LAN.</p> <p>Press +/- buttons to change the setting value and press &lt;, &gt; <b>arrow</b> buttons to move the cursor to next digit.</p> <p>Press <b>FEED</b> button to save the setting. The initial setting is " 0. 0. 0. 0".</p> <p><b>Note:</b> Changed settings will be in effect from the next power on.</p>
 <p>PORT NUMBER 1 PORT NUMBER 2 01025</p>	<p>Setting the Port number 1, 2 of LAN.</p> <p>Press +/- buttons to change the setting value and press &lt;, &gt; <b>arrow</b> buttons to move the cursor to next digit.</p> <p>Press <b>FEED</b> button to save the setting. Setting range is between 00000 and 65535. The initial value for Port number 1 is 01024, Port number 2 is 01025.</p> <p><b>Note:</b> Changed settings will be in effect from the next power on.</p>

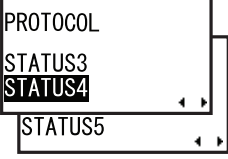
**3.7 INTERFACE MODE (Cont'd)**

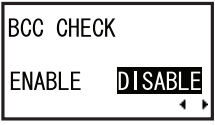
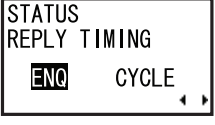

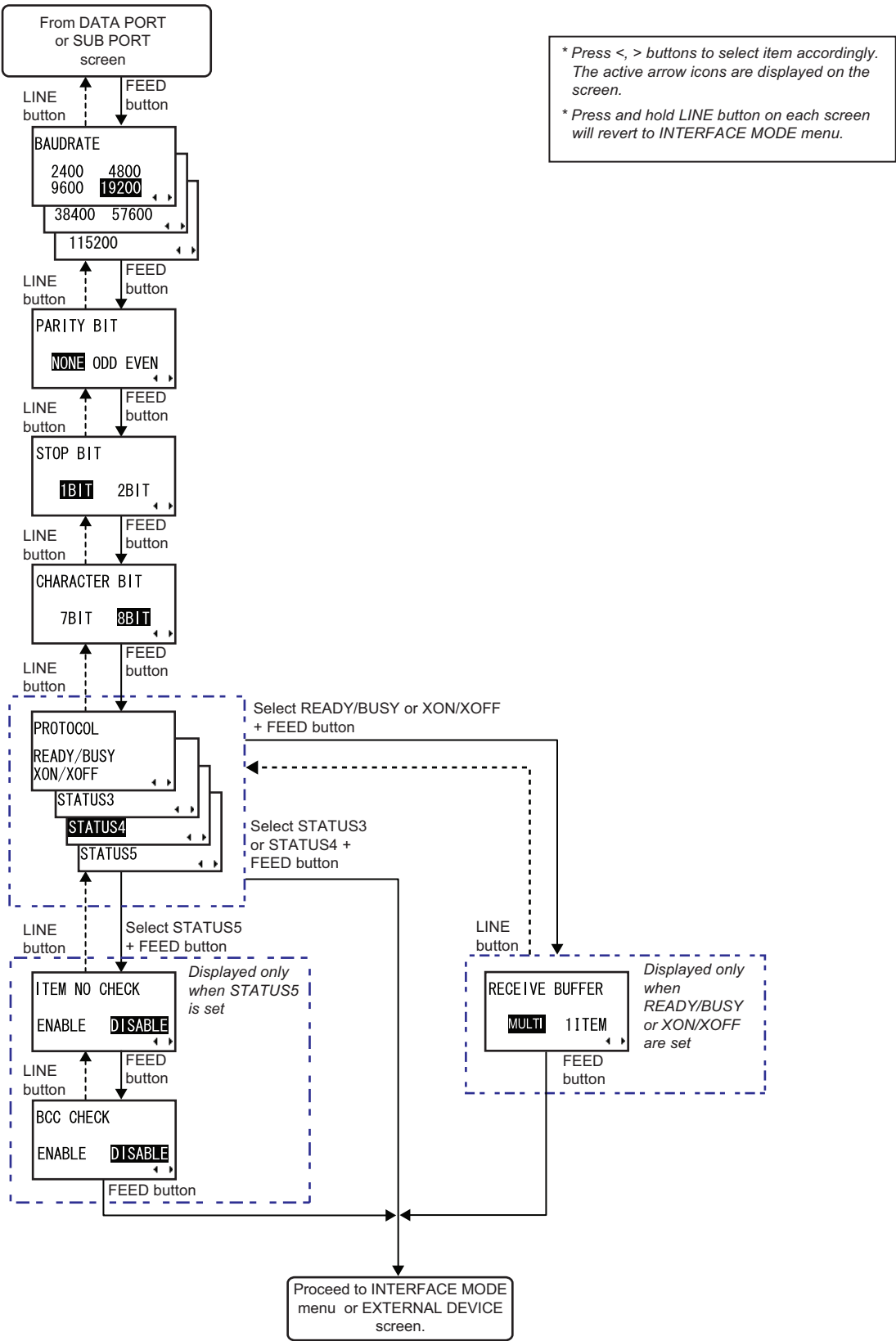

LAN CONFIGURATION	
Menu	Description
	<p>Select the communication protocol.                      STATUS3, STATUS4 and STATUS5 are available for selection when LAN interface boards are installed.                      The initial value is STATUS4.                      When STATUS3 is selected, the printer will proceed directly to INTERFACE MODE menu or EXTERNAL DEVICE screen.                      When STATUS4 is selected, the printer will proceed to STATUS REPLY TIMING menu.                      When STATUS5 is selected, the printer will proceed to ITEM NO CHECK menu.</p>
	<p>Set item number check function.  <b>ENABLE:</b> Item number check is ON  <b>DISABLE:</b> Item number check is OFF                      The initial value is DISABLE.                      This screen is displayed only when PROTOCOL is set to STATUS5.</p>
	<p>Set BCC check function.  <b>ENABLE:</b> BCC check is ON  <b>DISABLE:</b> BCC check is OFF                      The initial value is DISABLE.                      This screen is displayed only when PROTOCOL is set to STATUS5.</p>
	<p>Set status reply timing to the host.  <b>ENQ:</b> Returns status after receiving Status Request (ENQ), which was sent from the host  <b>CYCLE:</b> Returns status from the printer to the host at 500ms intervals                      The initial value is CYCLE.                      This screen is displayed only when PROTOCOL is set to STATUS4.</p>

3.7 INTERFACE MODE (Cont'd)

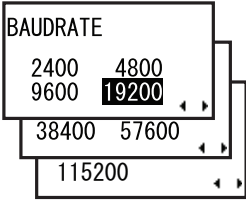

Setting of RS-232C

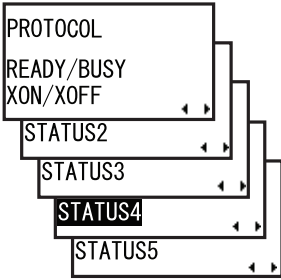

**3.7 INTERFACE MODE (Cont'd)**

RS-232C CONFIGURATION	
Menu	Description
	<p>Setting RS-232C baud rate. Press <b>arrow</b> buttons to set the baudrate as 2400, 4800, 9600, 19200, 38400, 57600 or 115200. Press <b>FEED</b> button to save the setting. The initial value is 19200.</p> <p><b>Note:</b> Changed settings will be in effect from the next power on.</p>
	<p>Setting RS-232C parity bit. NONE, ODD or EVEN can be selected. The initial value is NONE.</p> <p><b>Note:</b> Changed settings will be in effect from the next power on.</p>
	<p>Setting RS-232C stop bit. The initial value is 1BIT.</p> <p><b>Note:</b> Changed settings will be in effect from the next power on.</p>
	<p>Setting RS-232C character bit. The initial value is 8BIT.</p> <p><b>Note:</b> Changed settings will be in effect from the next power on.</p>
	<p>Setting communication protocol. The following protocols are available when RS-232C interface board is installed.</p> <ol style="list-style-type: none"> <li>1) READY/BUSY</li> <li>2) XON/OFF</li> <li>3) STATUS2</li> <li>4) STATUS3</li> <li>5) STATUS4</li> <li>6) STATUS5</li> </ol> <p>The initial value is STATUS4.</p> <p>When READY/BUSY or XON/XOFF is selected, the printer will proceed directly to RECEIVE BUFFER menu. When STATUS5 is selected, the printer will proceed directly to ITEM NO CHECK menu. When STATUS3 or STATUS4 is selected, the printer will proceed directly to IGNORE CR/LF menu.</p> <p><b>Note:</b> Changed settings will be in effect from the next power on</p>

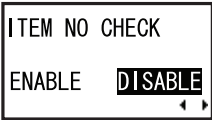
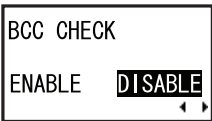

## 3.7 INTERFACE MODE (Cont'd)

RS-232C CONFIGURATION	
Menu	Description
	<p>Set item number check function.  <b>ENABLE:</b> Item number check is ON  <b>DISABLE:</b> Item number check is OFF            The initial value is DISABLE.            This screen is displayed only when PROTOCOL is set to STATUS5.</p>
	<p>Set BCC check function.  <b>ENABLE:</b> BCC check is ON  <b>DISABLE:</b> BCC check is OFF            The initial value is DISABLE.            This screen is displayed only when PROTOCOL is set to STATUS5.</p>
	<p>Setting receive buffer type.  <b>MULTI:</b> Multi buffer  <b>1ITEM:</b> Single item buffer            This screen is displayed only when PROTOCOL is set to READY/BUSY or XON/XOFF.             The initial value is MULTI.</p>

### 3.7 INTERFACE MODE (Cont'd)

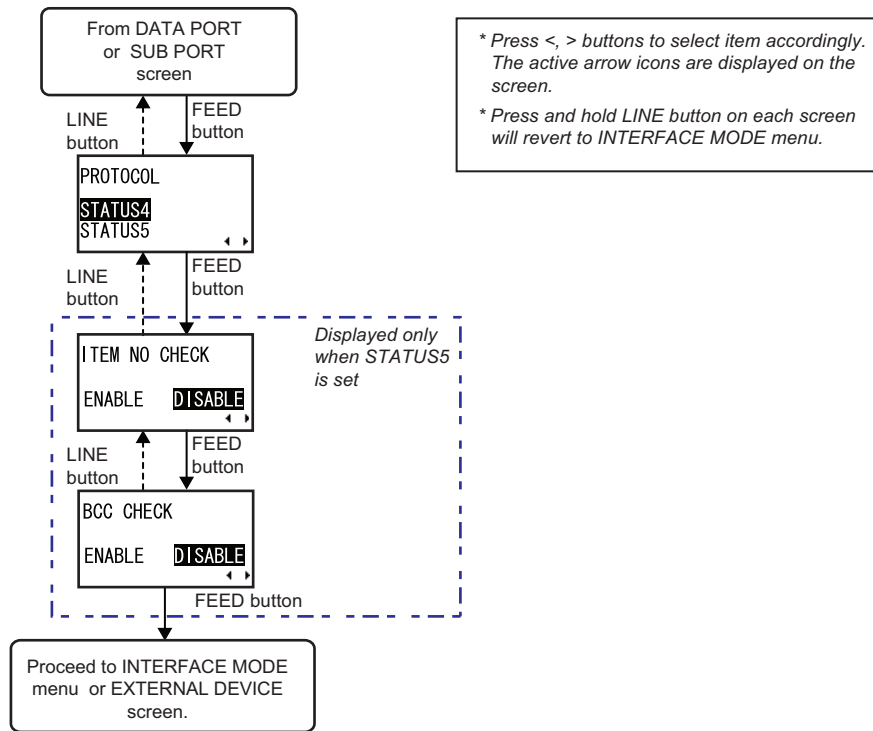
#### Setting of USB

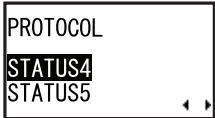

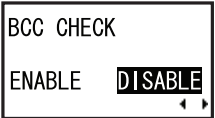
USB CONFIGURATION	
Menu	Description
	Select the communication protocol. STATUS4 and STATUS5 are available for selection when USB interface boards is installed. The initial value is STATUS4. When STATUS4 is selected, the printer will proceed directly to INTERFACE MODE menu. When STATUS5 is selected, the printer will proceed to ITEM NO CHECK menu.
	Set item number check function. <b>ENABLE:</b> Item number check is ON <b>DISABLE:</b> Item number check is OFF The initial value is DISABLE. This screen is displayed only when PROTOCOL is set to STATUS5.
	Set BCC check function. <b>ENABLE:</b> BCC check is ON <b>DISABLE:</b> BCC check is OFF The initial value is DISABLE. This screen is displayed only when PROTOCOL is set to STATUS5.



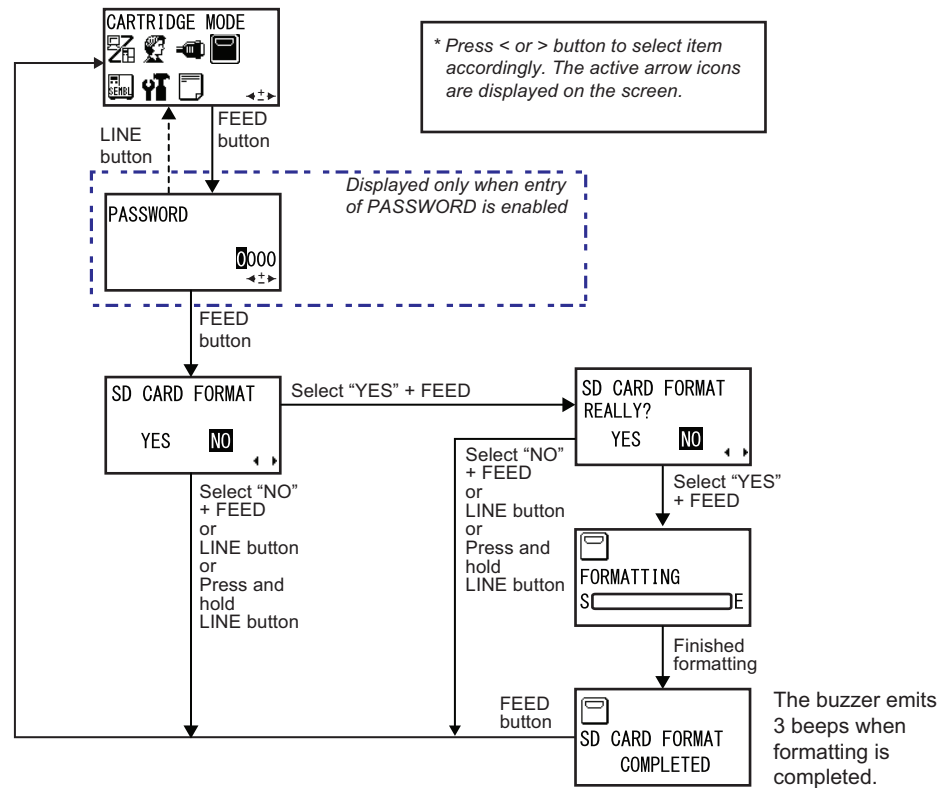

### 3.8 CARTRIDGE MODE

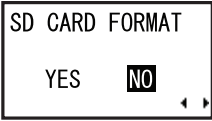
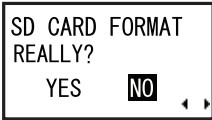

1. During OFFLINE mode, press + and < buttons simultaneously to display the operational icon menu. Press <, >, + or - buttons to select CARTRIDGE MODE.
2. When CARTRIDGE MODE is displayed, press the **FEED** button to enter CARTRIDGE MODE.  
**Note:**  
 PASSWORD may prompt on the display if SET PASSWORD is set to ON in the Service mode. Please refer to **Section 3.16.5 Overview of Setting menu in Service Mode** for details in password inputting.
3. SD CARD FORMAT is first prompted. Select YES + **FEED** button will switch to the next setting options as shown above. Pressing **LINE** button, or press and hold **LINE** button, or select NO + **FEED** will return to the CARTRIDGE MODE screen.

**3.8 CARTRIDGE MODE (Cont'd)**

CARTRIDGE MODE CONFIGURATION	
Menu	Description
 <p>SD CARD FORMAT YES <b>NO</b> ◀ ▶</p>	<p>Confirmation on formatting the storage area of memory card.  <b>YES:</b> Proceed to “SD CARD FORMAT REALLY?” screen.  <b>NO:</b> Return to CARTRIDGE MODE screen.                      The initial setting is NO.</p>
 <p>SD CARD FORMAT REALLY? YES <b>NO</b> ◀ ▶</p>	<p>Start of formatting the storage area of memory card.  <b>YES:</b> Proceed to start formatting.  <b>NO:</b> Return to CARTRIDGE MODE screen.                      The initial setting is NO.</p>
 <p>FORMATTING S <input type="text"/> E</p>	<p>This screen shows the status while formatting the storage area of memory card.                      After formatting the memory card, a completion message will appear.</p>
 <p>SD CARD FORMAT COMPLETED</p>	<p>This screen shows the completion of memory card formatting.                      The buzzer emits 3 beeps after formatting is completed.</p>

### 3.9 SEMBL MODE

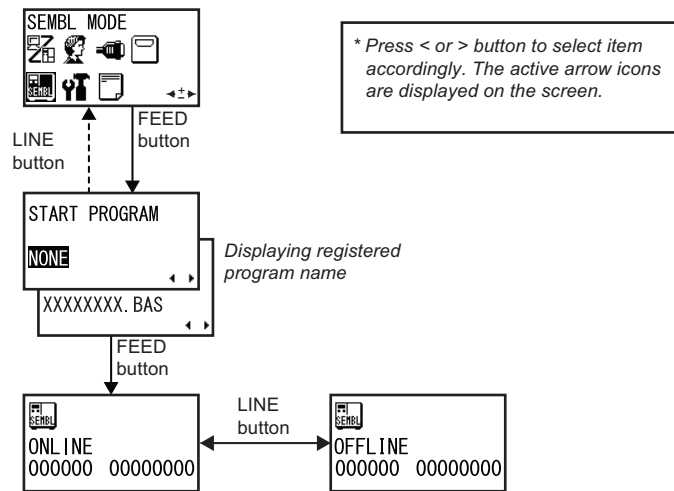

1. During OFFLINE mode, press **+** and **<** buttons simultaneously to display the operational icon menu. Press **<**, **>**, **+** or **-** buttons to select SEMBL MODE.
2. When SEMBL MODE is displayed, press the **FEED** button to activate the SEMBL operation.
3. START PROGRAM is first displayed. Press the **arrow** buttons to specify the start-up program.  
**NONE**: Not specifying start-up program  
**XXXXXXXXX.BAS**: Specifying startup program  
 Program names stored in the main memory will appear in XXXXXXXX.BAS.  
 The initial value is NONE.
4. Press **LINE** button to switch between online and offline in SEMBL MODE.

### 3.10 ADVANCED MODE

Advanced Mode lets you configure the more advanced features of the printer hardware.  
 Overview of Advanced Mode configurations

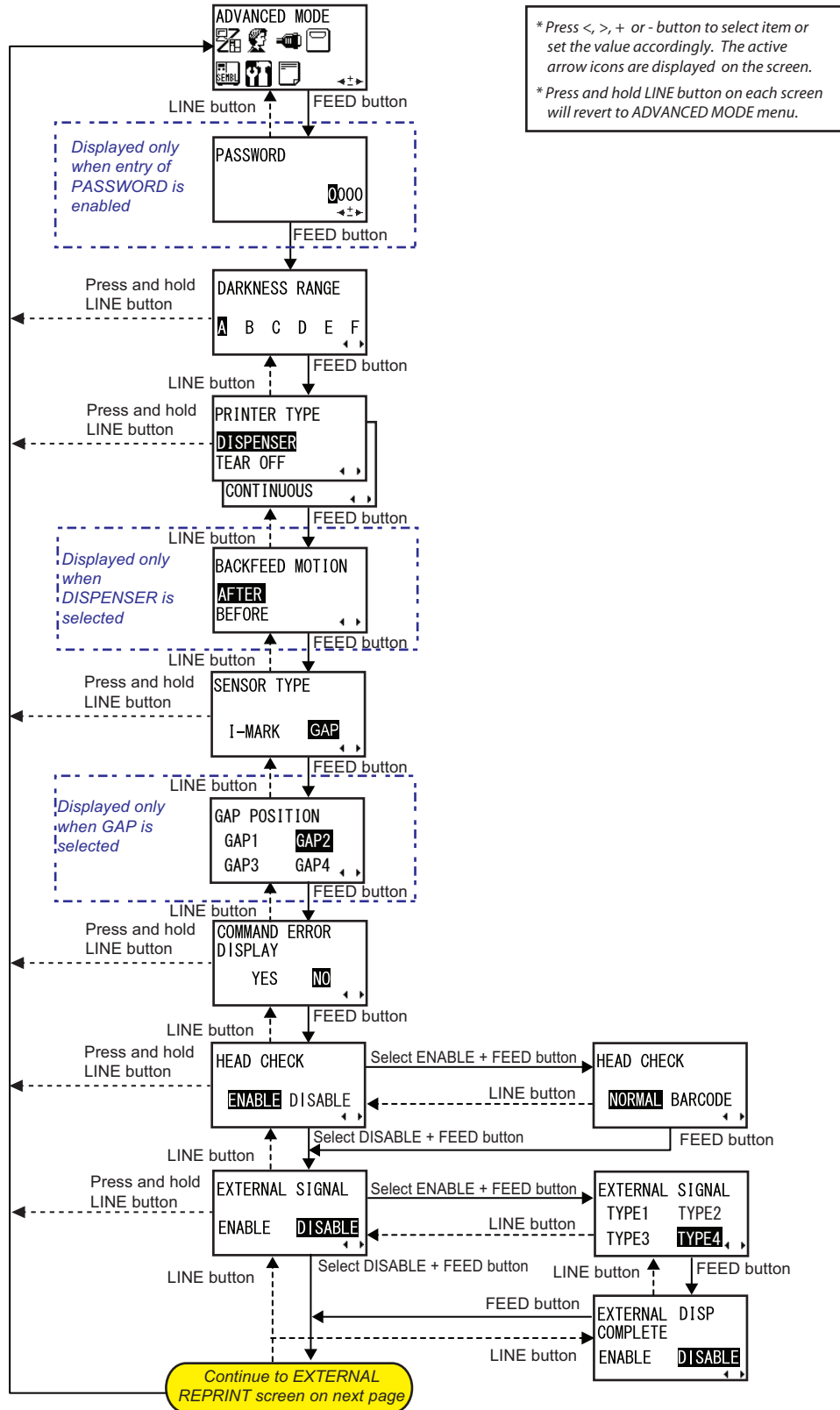

\* Press <, >, + or - button to select item or set the value accordingly. The active arrow icons are displayed on the screen.  
 \* Press and hold LINE button on each screen will revert to ADVANCED MODE menu.

3.10 ADVANCED MODE (Cont'd)

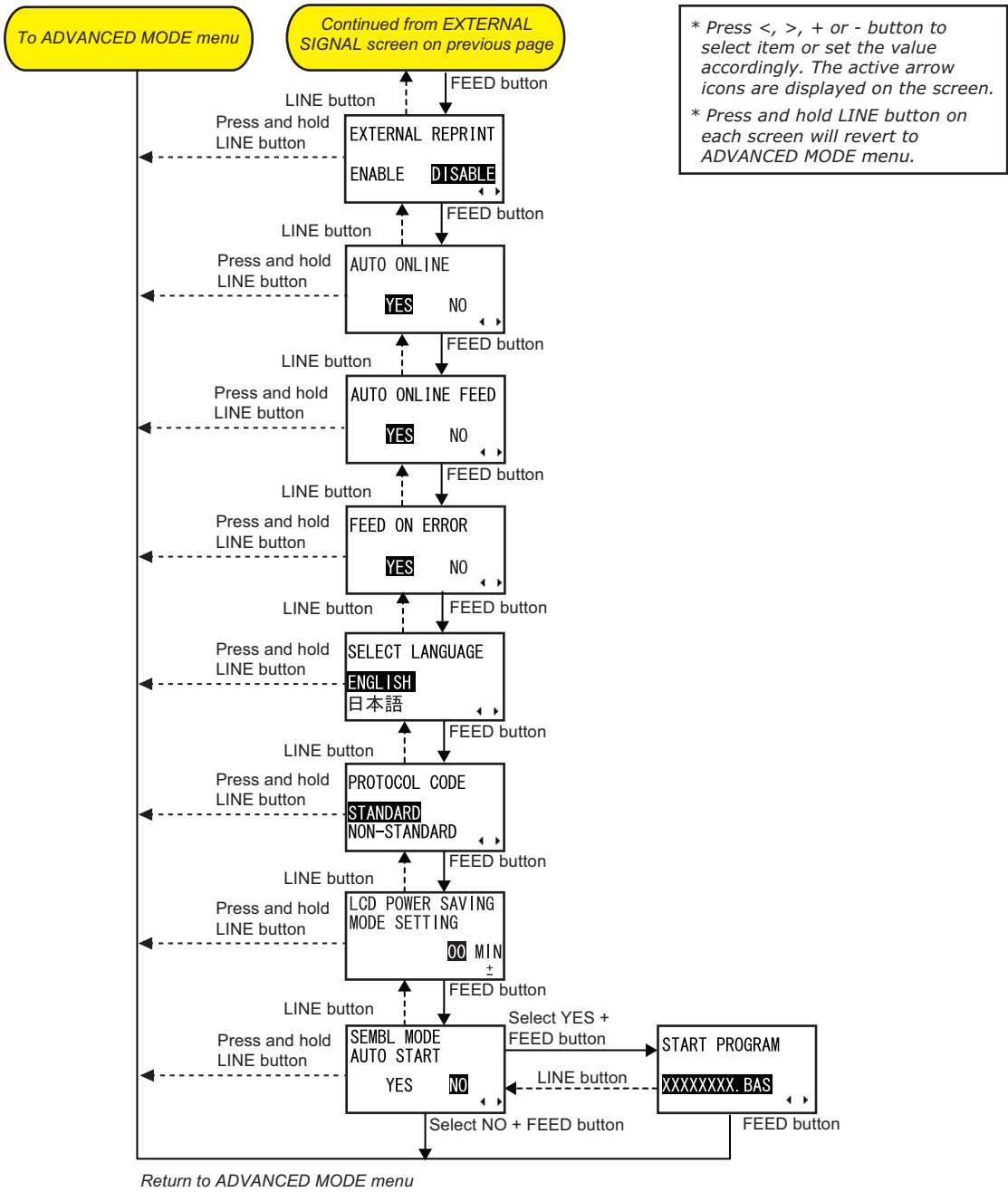



### 3.10 ADVANCED MODE (Cont'd)

1. During OFFLINE mode, press + and < buttons simultaneously to display the operational icon menu. Press <, >, + or - buttons to select ADVANCE MODE.
2. When ADVANCE MODE is displayed, press the **FEED** button to enter to Advance mode for adjustment.



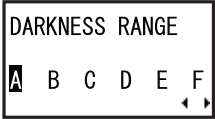
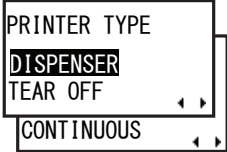

**Note:**

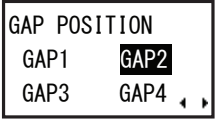
PASSWORD may prompt on the display if SET PASSWORD is set to ON in the Service mode. Please refer to **Section 3.16 Service Mode** for details in password inputting.

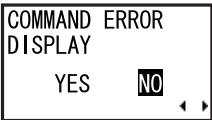

3. DARKNESS RANGE is first displayed. Press the **FEED** button repeatedly will switch to the next setting options as shown above. To return to the previous setting option, press **LINE** button. To return to ADVANCED MODE screen, press and hold **LINE** button.
4. When the desired setting option is displayed, press <, >, + or - buttons to select the item or to set the value and then press **FEED** button to save the setting.

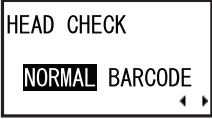
ADVANCED MODE	
Menu	Description
	<p>Setting print darkness range. Available options are A and B, with B being the darker density. C, D, E and F are reserved for future development. The initial setting is at A. <b>Note:</b> Adjustment of this setting is usually unnecessary.</p>
	<p>Setting printing mode. Allows the choices of dispenser, tear-off or continuous feed operation. When DISPENSER is selected, the printer will proceed to BACKFEED MOTION screen. When TEAR OFF or CONTINUOUS is selected, the printer will proceed directly to SENSOR TYPE screen. The initial setting is DISPENSER.</p>
	<p>Allows the selection of the backfeed motion that will be applied before or after the printing of each label. <b>AFTER:</b> Backfeed motion after printing (Motion 1) <b>BEFORE:</b> Backfeed motion before printing (Motion 2) The initial setting is AFTER.</p>
	<p>Set the pitch sensor to be selected relative to the media type to be used. Either I-MARK sensor or GAP sensor can be selected. The initial setting is GAP.</p>
	<p>Setting gap sensors. "GAP1": Set sensor on the far left to the printer. "GAP2": Set sensor on the 2nd from the left to the printer. "GAP3": Set sensor on the 3rd from the left to the printer. "GAP4": Set sensor on the 4th from the left to the printer. The default setting is "GAP2". This screen is displayed only when "GAP" sensor is selected.</p>

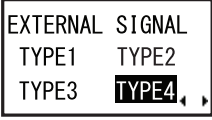
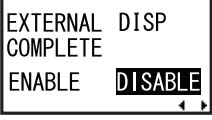
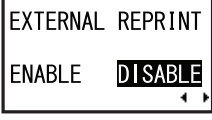
### 3.10 ADVANCED MODE (Cont'd)

ADVANCED MODE	
Menu	Description
	<p>Enabling/ Disabling the display of command error. This setting determines the printer motion when detecting a command error. <b>YES:</b> Stops printing operation when command error is occurred. <b>NO:</b> Displays a warning icon and continues printing operation. The initial value is NO.</p>
	<p>The printer can be set to perform a check of the print head when printing each label. <b>ENABLE:</b> Head check is ON Select <b>ENABLE</b> and press <b>FEED</b> button will proceed to HEAD CHECK menu. <b>DISABLE:</b> Head check is OFF Select <b>DISABLE</b> and press <b>FEED</b> button will proceed directly to EXTERNAL SIGNAL menu. The initial value is ENABLE.</p>
	<p>If Head Check has been ENABLE, you can specify the print head checking to be performed unconditionally, or only when barcodes are being printed. <b>NORMAL:</b> Head check is performed on the entire print head. <b>BARCODE:</b> Head check is performed only on position where barcodes are being printed. The initial value is NORMAL. This screen is displayed only when HEAD CHECK is set to ENABLE.</p>
	<p>Set this feature to enable or disable the printer's external signal communication port. If the port is enabled, data can be sent and received using an appropriate device plugged into the EXT port. <b>ENABLE:</b> Allowing external signal input/output. <b>DISABLE:</b> Not allowing external signal input/output. The initial setting is DISABLE.</p>
	<p>Setting the output signal type of PREND. This screen is displayed only when EXTERNAL SIGNAL is set to ENABLE. TYPE1, TYPE2, TYPE3 or TYPE4 can be selected. The initial setting is TYPE4.</p>
	<p>Output dispense waiting signal to external pin. <b>ENABLE:</b> Enables external signal output during waiting dispense. <b>DISABLE:</b> Disables external signal output during waiting dispense. This screen is displayed only when EXTERNAL SIGNAL is set to ENABLE. The initial setting is DISABLE. Note: Pin 9 or pin 10 can be selected for output in the EXTERNAL DISP PIN SELECT screen of the Service mode.</p>
	<p>Setting the reprint function by external signal (7-pin). <b>ENABLE:</b> Allowing reprint. <b>DISABLE:</b> Not allowing reprint. The initial setting is DISABLE.</p>

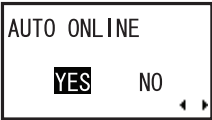
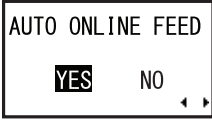
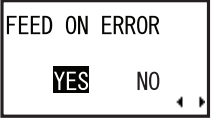
**3.10 ADVANCED MODE (Cont'd)**

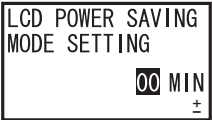
ADVANCED MODE	
Menu	Description
	<p>The printer can be set to go into ONLINE mode automatically after feeding the media automatically. Otherwise, the printer starts in the OFFLINE state.</p> <p><b>YES:</b> The printer goes online after feeding the paper automatically.  <b>NO:</b> The printer goes offline after feeding the paper automatically.  The initial value is YES.</p>
	<p>Setting the auto online feed function.  This function enables the printer to feed paper automatically in online state after starting up the printer.</p> <p><b>YES:</b> Feeding paper in online state after starting up the printer.  <b>NO:</b> Not feeding paper in online state after starting up the printer.  The initial setting is YES.</p> <p><b>Note:</b>  Online feed will not be performed when the printer type is set as Dispenser and GAP sensor is selected.</p>
	<p>Setting the online feed function.  This function enables the printer to feed paper automatically when recovering from a head open error or when starting up the printer and changing to online state.</p> <p><b>YES:</b> Feeding paper when changing to online state.  <b>NO:</b> Not feeding paper when changing to online state.  The initial setting is YES.</p> <p><b>Note:</b>  Online feed will not be performed when the printer type is set as Dispenser and GAP sensor is selected.</p>
	<p>Setting the display language on LCD.  The display languages are available in English or Japanese.  The initial value is ENGLISH.</p>
	<p>The ESC sequence in SBPL commands can be defined as standard (using non-printable code 1BH) or non-standard (some other user code).  The initial value is STANDARD.</p> <p>To set non-standard code, send the user download command &lt;LD&gt; in Normal Mode. For more details on the &lt;LD&gt; command, refer to the Command Specifications.</p>
	<p>LCD backlight is turned off for power saving when the printer is not operated for a specified period of time.  Set the time between 00 and 15 MIN.</p> <p>This power saving function is disabled when it is 00 MIN, and the LCD backlight will be on constantly.  The initial value is 00 MIN.</p>

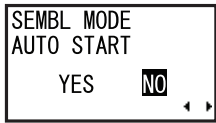
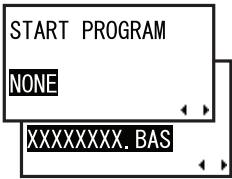

### 3.10 ADVANCED MODE (Cont'd)

ADVANCED MODE	
Menu	Description
	<p>This setting determines if the printer enters SEMBL mode automatically on being turned ON.</p> <p><b>YES:</b> Starting up SEMBL Mode at the time of power-on.</p> <p><b>NO:</b> Normal start up.</p> <p>The initial value is NO.</p>
	<p>Selecting the program to be executed when starting SEMBL Mode automatically.</p> <p><b>NONE:</b> Not specifying start -up program</p> <p><b>XXXXXXXX.BAS:</b> Specifying startup program</p> <p>Program names stored in the main memory will appear in XXXXXXXX.BAS.</p> <p>The initial value is NONE.</p> <p>This screen is displayed only when SEMBL MODE AUTO START is enabled.</p>

#### More about the Head Check function

- The head check function detects the integrity of the heating elements in the thermal print head. However, malfunctions cannot be detected instantaneously—a few printed labels may start showing printing defects before the printer warns of a print head error.
  - After detection of a print head error, use a scanner to check all affected labels.
  - When a head check error occurs during normal printing (barcodes, text and graphics), press and hold down the **FEED** button for five seconds. At the next screen, select BARCODE, then press **FEED** button and see if printing can be resumed normally. If printing resume, the print head faulty does not fall on the barcode area for the current print job. As such, printing may continue but with degraded print quality and readable barcode.
- If the head check error still occurs and the current print job has to be completed, the printing can be forced to resume by holding down the **LINE** and **FEED** buttons for five seconds. Please read the Attention below before you proceed this operation.

#### ATTENTION:

**Although restricting the head check type to BARCODE allows you to continue printing, or forcing the printer to resume printing, you should only do so in order to complete an urgent print job. Check the printed labels to make sure the output is usable in spite of the head error. As soon as possible, stop using the print head to prevent further damage. If necessary, get the print head replaced.**

### 3.11 HEX DUMP MODE

HEX Dump Mode allows you to print the contents of the receive buffer in a hexadecimal format to allow the data stream to be examined for errors and troubleshooting.

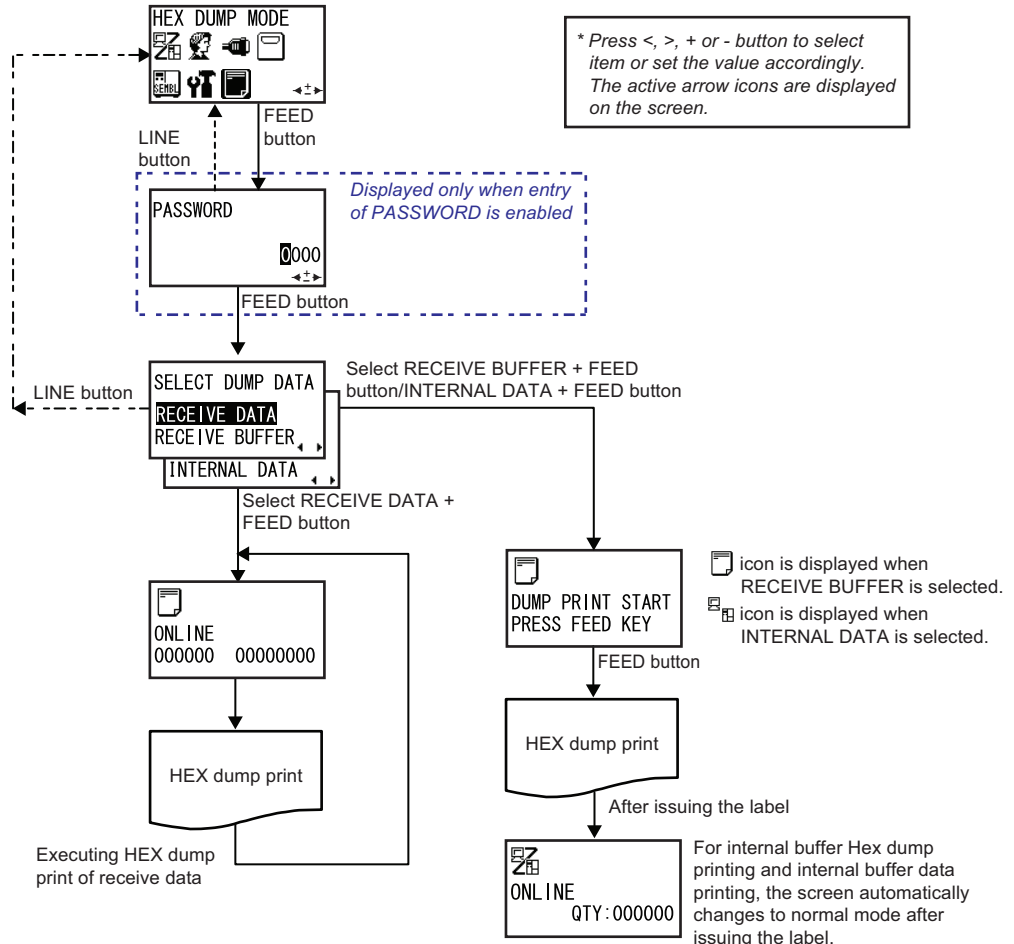

When HEX DUMP MODE is displayed, press the **FEED** button to enter to HEX Dump mode.

**Note:**

PASSWORD may prompt on the display if SET PASSWORD is set to ON in the Service mode. Please refer to **Section 3.16.5 Overview of Setting menu in Service Mode** for details in password inputting.

HEX DUMP MODE	
Menu	Description
	<p>Selecting the data for printing HEX dump.</p> <p><b>RECEIVE DATA:</b> Printing the HEX dump of received data.</p> <p><b>RECEIVE BUFFER:</b> Printing the HEX dump of received print data (1 item worth).</p> <p><b>INTERNAL DATA:</b> Printing the setting value for internal buffer. The initial value is <b>RECEIVE DATA</b>. Note that RECEIVE BUFFER cannot be selected when there is no received data.</p> <p>During HEX Dump Mode, the icon  is displayed in the ONLINE/OFFLINE screen.</p>

### 3.12 RECEIVED DATA SAVING MODE

Received Data Saving Mode allows you to save the contents of the receive buffer and FRAM in a hexadecimal format to the SD card. The stored data stream can be used to examine for errors and troubleshooting.

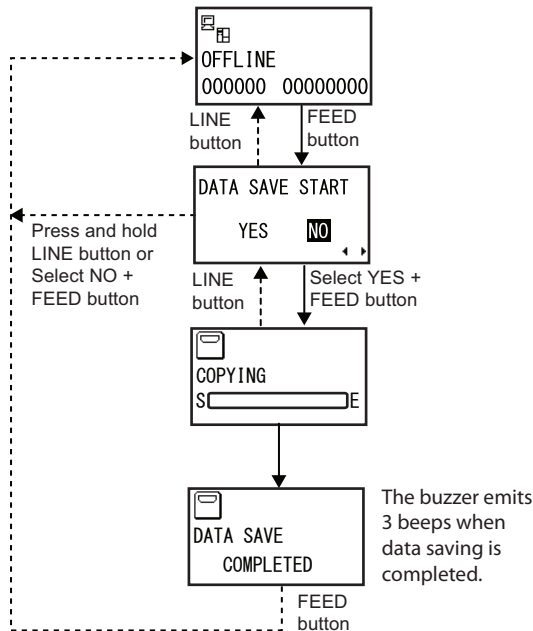



When the printer is in OFFLINE mode and the received data is still in buffer memory, press **FEED** button to display DATA SAVE START confirmation screen.

**Note:**

Ensure that the SD card is formatted and installed to the printer.

Press <,> arrow button to select YES to proceed copying the data to the SD card.

RECEIVED DATA SAVING MODE	
Menu	Description
	Confirming saving data in receive buffer and FRAM to SD card. <b>YES:</b> Copy the data to the SD card. <b>NO:</b> Do not copy the data to the SD card  The initial value is <b>NO</b> .
	Copying the data to the SD card. The gauge shown on the lower portion of screen indicates data copying status.  After copying the data, it goes to DATA SAVE COMPLETED screen.
	Completion of data saving. The buzzer emits 3 beeps when data saving is completed. Press <b>FEED</b> button to go to OFFLINE menu.



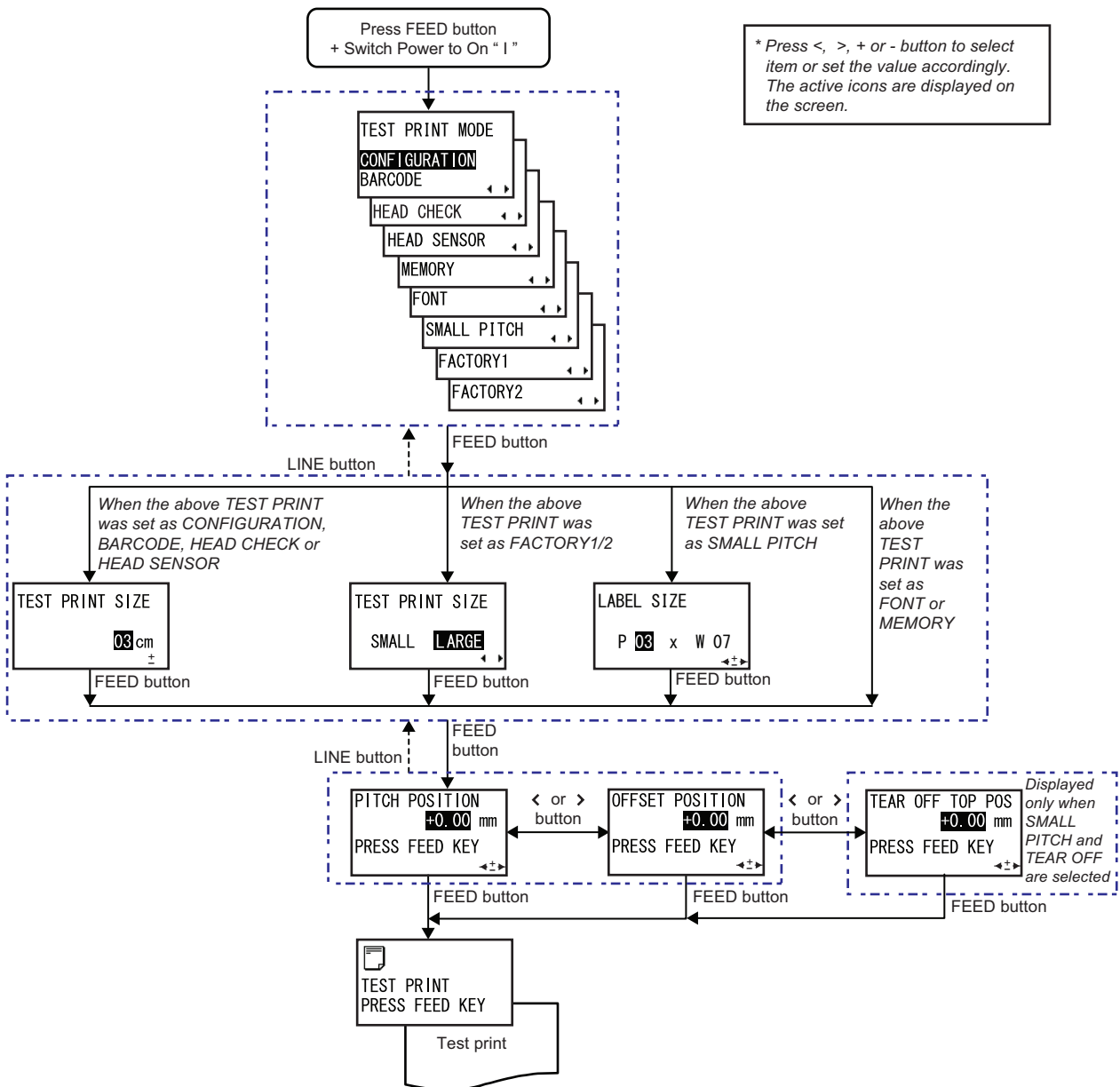

### 3.13 TEST PRINT MODE



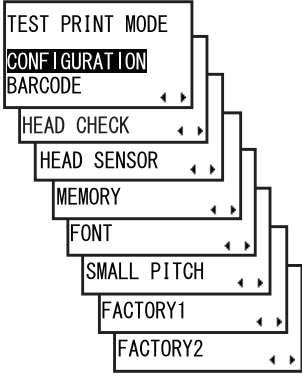

The Test Print Mode offers nine different printer status labels for troubleshooting.

1. Make sure the Power of the printer is turned off (O).
2. While pressing the **FEED** button, switch the Power to On (I).
3. TEST PRINT MODE is displayed on the screen. Press the **FEED** button repeatedly will switch to the next setting options as shown above. To return to the previous setting option, press **LINE** button.
4. When the desired setting option is displayed, press **+**, **-** or **< >** arrow buttons to select the item or to set the value and then press **FEED** button to save the setting.

## 3.13 TEST PRINT MODE (Cont'd)

TEST PRINT MODE	
Menu	Description
	<p>Choosing the Test Print Contents.</p> <p><b>CONFIGURATION:</b> The configuration settings of the printer will be printed.</p> <p><b>BARCODE:</b> The barcodes installed in this printer will be printed.</p> <p><b>HEAD CHECK:</b> The head check pattern of the selected media size area will be printed.</p> <p><b>HEAD SENSOR:</b> The head check pattern and the sensor rating will be printed.</p> <p><b>MEMORY:</b> The contents of the memory in this printer will be printed.</p> <p><b>FONT:</b> The contents of the fonts installed in this printer will be printed.</p> <p><b>SMALL PITCH:</b> Test pattern for adjusting pitch for small pitch label will be printed.</p> <p><b>FACTORY1:</b> The first half factory test print will be performed.</p> <p><b>FACTORY2:</b> The second half factory test print will be performed.</p> <p>The initial value is CONFIGURATION.</p>
	<p>If you chose test prints of Configuration, Barcode, Head Check or Head Sensor in the previous menu, this screen lets you choose the width of the test print from 03 to 06 cm (1.18" to 2.36"), in increments of 1 cm (0.39").</p> <p>The initial size is 03cm (1.18").</p>
	<p>For Factory test prints, this screen appears instead of the previous screen for setting print size. In this screen, you can choose only to print the test results in LARGE or SMALL print widths.</p> <p><b>SMALL:</b> Test print in 3cm (1.18") width</p> <p><b>LARGE:</b> Test print in 6cm (2.36") width</p> <p>The initial value is LARGE.</p>
	<p>Allows to select label size.</p> <p>P: label length (mm)</p> <p>W: label width (mm)</p> <p>The initial value is 3 mm (0.12") long and 7 mm (0.27") wide.</p> <p>Setting range is 03 to 10 mm (0.12" to 0.39") for length and 7 to 56 mm (0.27" to 2.2") for width, both in increments of 1 mm (0.04").</p>

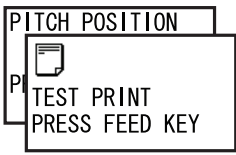
**3.13 TEST PRINT MODE (Cont'd)**

TEST PRINT MODE	
Menu	Description
	<p>Adjusting the print and offset positions.                      Press +/- buttons to change the setting value and press &lt;, &gt; <b>arrow</b> buttons to toggle between PITCH POSITION and OFFSET POSITION setting.                      Both setting range are ±3.75mm (±0.15") and are adjustable by 0.25mm (±0.01").                      The initial value is +0.00mm.                      Press <b>FEED</b> button to start test printing.</p>
	<p>Adjusting the top position after power on or cover open/close.                      Press +/- buttons to change the setting value and press &lt;, &gt; <b>arrow</b> buttons to toggle between PITCH POSITION and OFFSET POSITION setting.                      Both setting range are ±3.75mm (±0.15") and are adjustable by 0.25mm (±0.01").                      The initial value is +0.00mm.                      Press <b>FEED</b> button to start test printing.                      This screen is only displayed when SMALL PITCH and TEAR OFF are selected.</p>
	<p>Test print is in progress                      Press <b>FEED</b> button while printing will pause the test print operation. Press <b>FEED</b> again to continue.                      Label feed before printing is performed by PRINTER TYPE selection.                      Refer to following table.(*1)</p>

\*1 Condition to feed one label before test print

No	Test print item	Dispense	Tear Off	Continuous
1	FACTORY1	Starts print after default operation.	Feeds one label after initial operation and start printing.	Feeds one label after initial operation and start printing.
2	FACTORY2			
3	HEAD SENSOR			
4	CONFIGURATION		Start printing after initial operation. Feeds one label after initial operation and start printing by setting of [AUTO ONLINE FEED], [FEED ON ERROR].	Start printing after initial operation. Feeds one label after initial operation and start printing by setting of [AUTO ONLINE FEED], [FEED ON ERROR].
5	BARCODE			
6	HEAD CHECK			
7	MEMORY			
8	FONT			
9	SMALL PITCH			

### 3.13 TEST PRINT MODE (Cont'd)

#### 3.13.1 Types of Test Print

The following test print types are available.

1. Factory Test Print 1
2. Factory Test Print 2
3. Configuration Printout
4. Print of Supported Barcodes
5. Print of Head Check
6. Print Head and Sensor Check
7. Memory state
8. Print of Supported Fonts
9. Print Test Pattern for Small Pitch Label

#### 3.13.2 Explanation of the contents of each piece of Factory Test Print 1

Factory test print enables to print out the printer setting.

Printed contents are subject to change without notice and the value depends on individual settings.

The printer setting will be printed on three pages.

1)First page--

Item name (Print)	Item name	Description						
Model Name	Model Name	Printing the printer's model name. <table border="1" data-bbox="730 1205 1257 1323"> <thead> <tr> <th>Head dot density</th> <th>Model</th> </tr> </thead> <tbody> <tr> <td>12 dot/mm</td> <td>HR212</td> </tr> <tr> <td>24 dot/mm</td> <td>HR224</td> </tr> </tbody> </table>	Head dot density	Model	12 dot/mm	HR212	24 dot/mm	HR224
Head dot density	Model							
12 dot/mm	HR212							
24 dot/mm	HR224							
Firm Version(Font Ver)	Firmware version and font version	41.xx.xx.xx(xx.xx(R)) Font version is Kanji font version shown in the table. Font version is not included in CODE39 barcode.						
Firm Date	Firmware creation date	YY.MM.DD (The last two digits of the year, month, and date)						
S/N	Printer's serial No.	xxxxxxx						
CONT S/N	CONT PCB's serial No.	xxxxxxx						

**3.13 TEST PRINT MODE (Cont'd)**

Item name (Print)	Item name	Description
PCB Rev.	CONT PCB's version	x.x
DSW	Dip switch setting	ON/OFF

2)Second page --

Item name (Print)	Item name	Description						
Model Name	Model Name	Printing the printer's model name. <table border="1" style="margin-left: 40px;"> <thead> <tr> <th>Head dot density</th> <th>Model</th> </tr> </thead> <tbody> <tr> <td>12 dot/mm</td> <td>HR212</td> </tr> <tr> <td>24 dot/mm</td> <td>HR224</td> </tr> </tbody> </table>	Head dot density	Model	12 dot/mm	HR212	24 dot/mm	HR224
Head dot density	Model							
12 dot/mm	HR212							
24 dot/mm	HR224							
FROM1 CHECK SUM	Firmware's checksum	Printing the checksum value in firmware area and CODE39 barcode. (A) xxxx (B) xxxx (P) xxxx (E) xxxx (K) xxxx Checksum value differs depending on firmware version.						
LAN MAC Address	LAN MAC Address	xx:xx:xx:xx:xx:xx						
Pitch Offset Backfeed	Print start position Print stop position Backfeed amount	Printing pitch position, offset position and backfeed value for each sensor type. +xx(dot) +xx(dot) +xx(dot)						
Label Size	Label Size	Printing the label size set in the printer. (P)xxxx x (W)xxxx(dot)						
TearOff Offset	Tear Off Pitch	Printing the offset for the first label in Tear off operation. +x.xx(mm)						

3)Third page --

Item name (Print)	Item name	Description						
Model Name	Model Name	Printing the printer's model name. <table border="1" style="margin-left: 40px;"> <thead> <tr> <th>Head dot density</th> <th>Model</th> </tr> </thead> <tbody> <tr> <td>12 dot/mm</td> <td>HR212</td> </tr> <tr> <td>24 dot/mm</td> <td>HR224</td> </tr> </tbody> </table>	Head dot density	Model	12 dot/mm	HR212	24 dot/mm	HR224
Head dot density	Model							
12 dot/mm	HR212							
24 dot/mm	HR224							
Life Counter	Life Counter	Printing the total usage. xxxxx.x(km)						



### 3.13 TEST PRINT MODE (Cont'd)

Item name (Print)	Item name	Description
Head Counter1 Head Counter2/3	Head counter 1, 2, 3	Printing the total usage of print head. xxxxx.x(km)
Dispenser Counter	Dispenser Counter	Printing the dispenser usage. xxxxx.x(km)
Head-Check [All]	Head check result	Performing head check and printing out its result. Head check OK: OK Head check NG: NG (NG will be highlighted)
F-Pitch Offset(VR)	Factory Pitch Off- set	Printing the factory pitch offset. x.xx(mm)
Reflective Sensor Low [Lo<0.4] x.x(V) High[0.9<Hi-Lo] x.x(V) Slice Level Auto	Sensor type	Printing this information when reflective sensor (I-Mark) is selected. If "Low" is not [Low < 0.4], "Low" will be indicated in reverse colors. If "High" is not [0.9 < (High-Low)], "High" will be indicated in reverse colors.
Transmissive Sensor GAPx Low [0.1<Lo<0.6] x.x(V) High[0.9<Hi-Lo] x.x(V) Slice Level Auto	Sensor type	Printing this information when transmissive sensor (GAP) is selected. Indicates GAP sensor number in use by "x" in "GAP(x)". If "Low" is not [0.6 < Low < 1.0], "Low" will be indicated in reverse color. If "High" is [0.9 < (High-Low)], "High" will be indicated in reverse colors.
Data/Sub Port	Data/Sub Port con- nection	LAN ( / RS-232C / USB ) / None ( / RS-232C / USB / LAN)
Pitch(LCD)	Print position adjustment value	Printing the pitch position set through LCD screen. ±3.75(mm)
Offset(LCD)	Stop position adjustment value	Printing the offset position set through LCD screen. ±3.75(mm)
Darkness(LCD)	Darkness adjust- ment value	Printing the print darkness set through LCD screen 00~99
Print Speed	Print Speed	1.0 ~ 4.0 (inch/s)
Print Darkness	Print Darkness/ Range	Printing the print darkness and darkness range. 1A, 2A, 3A, 4A, 5A, 1B, 2B, 3B, 4B, 5B
Print Offset	Print Offset	Printing the offset position for printing. For 12dot/mm: (H)±2400 (V)±672(dot) For 24dot/mm: (H)±4800 (V)±1344(dot)
Operation Mode	Operation mode setting	Printing the name of selected operation mode. Continuous mode: Continuous Dispense mode: Dispense Tear-off mode: Tear Off

**3.13 TEST PRINT MODE (Cont'd)**

---

<b>Item name (Print)</b>	<b>Item name</b>	<b>Description</b>
Backfeed Action	Backfeed motion setting	After printing (Motion 1): Action1 Before printing (Motion 2): Action2 No backfeed motion: None
Head Check	Head Check setting	When head check is disabled: None When head check is enabled: Checking actual print area: Normal Checking barcode print area: Barcode

### 3.13 TEST PRINT MODE (Cont'd)

#### 3.13.3 Explanation of the contents of each piece of Factory Test Print 2

Factory test print enables to print out the printer setting.

Printed contents are subject to change without notice and the value depends on individual settings.

The printer setting will be printed on four pages.

1)First page --

Item name (Print)	Item name	Description						
Model Name	Model Name	Printing the printer's model name. <table border="1" data-bbox="727 651 1256 770"> <thead> <tr> <th>Head dot density</th> <th>Model</th> </tr> </thead> <tbody> <tr> <td>12 dot/mm</td> <td>HR212</td> </tr> <tr> <td>24 dot/mm</td> <td>HR224</td> </tr> </tbody> </table>	Head dot density	Model	12 dot/mm	HR212	24 dot/mm	HR224
Head dot density	Model							
12 dot/mm	HR212							
24 dot/mm	HR224							
Firm Version(Font Ver)	Firmware version and font version	41.xx.xx.xx(xx.xx(R)) Font version is Kanji font version shown in the table. Font version is not included in CODE39 barcode.						
Firm Date	Firmware creation date	YY.MM.DD (The last two digits of the year, month, and date)						
S/N	Printer's serial No.	xxxxxxx						
CONT S/N	CONT PCB's serial No.	xxxxxxx						
PCB Rev.	CONT PCB's version	x.x						
Life Counter	Life Counter	Printing the total usage. xxxxx.x(km)						
Head Counter1 Head Counter2/3	Head counter 1, 2, 3	Printing the total usage of print head. xxxxx.x(km)						
Dispenser Counter	Dispenser Counter	Printing the dispenser usage. xxxxx.x(km)						

**3.13 TEST PRINT MODE (Cont'd)**

Item name (Print)	Item name	Description
FROM1 CHECK SUM	Firmware's check-sum	Printing the checksum value in firmware area and CODE39 barcode. (A) xxxx (B) xxxx (P) xxxx (E) xxxx (K) xxxx Checksum value differs depending on firmware version.
LAN MAC Address	LAN MAC Address	xx:xx:xx:xx:xx:xx

2)Second page --

Item name (Print)	Item name	Description
Head-Check [All]	Head check result	Performing head check and printing out its result. Head check OK: OK Head check NG: NG (NG will be highlighted)
F-Pitch Offset(VR)	Factory Pitch Offset	Printing the factory pitch offset. x.xx(mm)
Priority Setting	Priority Setting	Printing the configuration of system setting commands. Command / Internal
Total Counter Display	Total Counter Display	Printing display type of total print quantity. Prints "On" when display. Prints "Off" when doesn't display.
LCD Brightness	LCD Brightness	Printing LCD brightness setting. 00~32
Reprint	Reprint	Printing reprint ON/OFF. When reprint is enabled, "ON" will be printed. When reprint is disabled, "Off" will be printed.
Pitch Offset Backfeed	Print start position Print stop position Backfeed amount	Printing pitch position, offset position and backfeed value for each sensor type. +xx(dot) +xx(dot) +xx(dot)
Label Size	Label Size	Printing the label size set in the printer. (P)xxxx x (W)xxxx(dot)
TearOff Offset	Tear Off Pitch	Printing the offset for the first label in Tear off operation. +x.xx(mm)
DSW	Dip switch setting	ON/OFF

### 3.13 TEST PRINT MODE (Cont'd)

3)Third page --

Item name (Print)	Item name	Description
Print Speed	Print Speed	1.0 ~ 4.0 (inch/s)
Print Darkness	Print Darkness/ Range	Printing the print darkness and darkness range. 1A, 2A, 3A, 4A, 5A, 1B, 2B, 3B, 4B, 5B
Print Offset	Print Offset	Printing the offset position for printing. For 12dot/mm: (H)±2400 (V)±672(dot) For 24dot/mm: (H)±4800 (V)±1344(dot)
Zero Slash	Zero slashing set- ting	Zero with a slash through it: ON Zero without a slash: Off
Character Code	Character code setting	JIS code: JIS SJIS code: SJIS Unicode: Unicode
Character Pitch	Proportional pitch setting	Proportional pitch: Proportional Fixed pitch: Fixed
Operation Mode	Operation mode setting	Printing the name of selected operation mode. Continuous mode: Continuous Dispense mode: Dispense Tear-off mode: Tear Off
Backfeed Action	Backfeed motion setting	After printing (Motion 1): Action1 Before printing (Motion 2): Action2 No backfeed motion: None
Head Check	Head Check set- ting	When head check is disabled: None When head check is enabled: Checking actual print area: Normal Checking barcode print area: Barcode
Auto Online	Auto Online	Yes/No
Initial Feed	Initial Feed	Enabled/Disabled
Online Feed	Feed on error	Enabled/Disabled
Command Error	Command Error	Printing the command error setting. Prints Error: when enabled. Prints Warning: when disabled.
LCD Power Saving	LCD Power Saving	Printing the transition time of LCD power save mode in minutes. xx (min)
Protocol Code	Protocol code set- ting	Standard code: Standard Non-standard code: Non-Standard Also, the protocol code set for the printer will be printed out. STX:xxH, ETX:xxH, ESC:xxH, ENQ:xxH, CAN:xxH, NULL:xxH, OFFLINE:xxH

**3.13 TEST PRINT MODE (Cont'd)**

Item name (Print)	Item name	Description
Pitch(LCD)	Print position adjustment value	Printing the pitch position set through LCD screen. ±3.75(mm)
Offset(LCD)	Stop position adjustment value	Printing the offset position set through LCD screen. ±3.75(mm)
Darkness(LCD)	Darkness adjustment value	Printing the print darkness set through LCD screen 00~99
EXT Signal	EXT Signal setting	Printing external signal setting. Enabled: Enabled Prints TYPE1, TYPE2, TYPE3 or TYPE4 according to selected external signal type. Disabled: Disabled
EXT Signal(Dispenser)	EXT Signal(Dispenser) setting	Printing setting of dispense completion signal. Enabled: Enabled Disabled: Disabled Doesn't print when [EXT SIGNAL] is DISABLE.
EXT Signal(Reprint)	EXT Signal(Reprint) setting	Printing reprint setting. Enabled: Enabled Disabled: Disabled

4)Forth page --

Item name (Print)	Item name	Description
Keypad	Keypad	Printing setting of Keypad connection Enabled: Enabled Disabled: Disabled
Data Port	Data Port	LAN / RS-232C / USB
Sub Port	Sub Port	None / RS-232C / USB / LAN
<b>Interface display</b>		
LAN		
Protocol	Protocol setting	STATUS3 STATUS4 (ENQ) STATUS4 (CYC) STATUS5
Item No. Check (When STATUS5 is selected)	Item No. check setting	ENABLE / DISABLE
BCC Check (When STATUS5 is selected)	BCC check setting	ENABLE / DISABLE
RARP setting	RARP setting	ENABLE / DISABLE

### 3.13 TEST PRINT MODE (Cont'd)

Item name (Print)	Item name	Description
STATUS REPLY TIMING (When STATUS4 or STATUS5 is selected)	IP address	ENQ / CYCLE
IP Address	IP address	xxx.xxx.xxx.xxx
Subnet Mask	Subnet mask	xxx.xxx.xxx.xxx
Gateway Address	Default gateway	xxx.xxx.xxx.xxx
DHCP/RARP	DHCP/RARP setting	ENABLE / DISABLE
Port 1/2	LAN port number 1 and 2	xxxxx
<b>RS-232C</b>		
Protocol	Protocol setting	READY/BUSY XON/XOFF STATUS2 STATUS3 STATUS4 STATUS5
Item No. Check (When STATUS5 is selected)	Item No. check setting	ENABLE / DISABLE
BCC Check (When STATUS5 is selected)	BCC check setting	ENABLE / DISABLE
Receive Buffer	Receive buffer type	MULTI / 1ITEM
Baudrate	Baud rate setting	2400 / 4800 / 9600 / 19200 / 38400 / 57600 / 115200(bps)
Parity	Parity setting	NONE / ODD / EVEN
Data Bit	Data length setting	7 / 8 (BIT)
Stop Bit	Stop bit setting	1BIT / 2BIT
<b>USB</b>		
Protocol	Protocol setting	STATUS4 STATUS5
Item No. Check (When STATUS5 is selected)	Item No. check setting	ENABLE / DISABLE
BCC Check (When STATUS5 is selected)	BCC check setting	ENABLE / DISABLE

**3.13 TEST PRINT MODE (Cont'd)****3.13.4 Explanation of the contents of Configuration Test Print**

1)First page --

Item name (Print)	Description
Print Speed	1.0 ~ 4.0 (inch/s)
Print Darkness	Printing the print darkness and darkness range. 1A, 2A, 3A, 4A, 5A, 1B, 2B, 3B, 4B, 5B
Print Offset	Printing the offset position for printing. For 12dot/mm: (H)±2400 (V)±672(dot) For 24dot/mm: (H)±4800 (V)±1344(dot)
Zero Slash	Zero with a slash through it: ON Zero without a slash: Off
Character Code	JIS code: JIS SJIS code: SJIS Unicode: Unicode
Character Pitch	Proportional pitch: Proportional Fixed pitch: Fixed
Operation Mode	Printing the name of selected operation mode. Continuous mode: Continuous Dispense mode: Dispense Tear-off mode: Tear Off
Backfeed Motion	After printing (Motion 1): Action1 Before printing (Motion 2): Action2 No backfeed motion: None
Head Check	When head check is disabled: None When head check is enabled: Checking actual print area: Normal Checking barcode print area: Barcode
Auto Online	Yes/No
Initial Feed	Enabled/Disabled
Feed On Error	Enabled/Disabled
Command Error	Printing the command error setting. Prints Error: when enabled. Prints Warning: when disabled.
LCD Power Saving	Printing the transition time of LCD power save mode in minutes. xx (min)
Protocol Code	Standard code: Standard Non-standard code: Non-Standard Also, the protocol code set for the printer will be printed out. STX:xxH, ETX:xxH, ESC:xxH, ENQ:xxH, CAN:xxH, NULL:xxH, OFFLINE:xxH
Euro Code	xxH



**3.13 TEST PRINT MODE (Cont'd)**

2)Second page --

Item name (Print)	Description
Reflective Sensor Low [Lo<0.4] x.x(V) High[0.9<Hi-Lo] x.x(V) Slice Level Auto	Printing this information when reflective sensor (I-Mark) is selected. If "Low" is not [Low < 0.4], "Low" will be indicated in reverse colors. If "High" is not [0.9 < (High-Low)], "High" will be indicated in reverse colors.
Transmissive Sensor GAPx Low [0.1<Lo<0.6] x.x(V) High[0.9<Hi-Lo] x.x(V) Slice Level Auto	Printing this information when transmissive sensor (GAP) is selected. Indicates GAP sensor number in use by "x" in "GAP(x)". If "Low" is not [0.6 < Low < 1.0], "Low" will be indicated in reverse color. If "High" is [0.9 < (High-Low)], "High" will be indicated in reverse colors.
Pitch(LCD)	Printing the pitch position set through LCD screen. ±3.75(mm)
Offset(LCD)	Printing the offset position set through LCD screen. ±3.75(mm)
Darkness(LCD)	Printing the print darkness set through LCD screen 00~99
EXT Signal	TYPE1, TYPE2, TYPE3 or TYPE4
EXT Dispenser	Enabled/Disabled
EXT Reprint	Enabled/Disabled
Label Size	Printing the label size set in the printer. (P)xxxx x (W)xxxx(dot)
DSW	ON/OFF

3)Third page --

Item name (Print)	Description
Keypad	Enabled/Disabled
DATA PORT	LAN / RS-232C / USB
SUB PORT	None / RS-232C / USB / LAN
<b>Interface display</b>	
LAN	
Protocol	STATUS3 STATUS4 (ENQ) STATUS4 (CYC) STATUS5
RS-232C	
Protocol	READY/BUSY XON/XOFF STATUS2 STATUS3 STATUS4 STATUS5
USB	
Protocol	STATUS4 STATUS5

### **3.13 TEST PRINT MODE (Cont'd)**

---

#### **3.13.5 Print of Supported Barcodes**

The barcodes used for test print are as follows.

1. CODABAR(NW-7)
2. ITF
3. JAN/EAN 8
4. MATRIX 2/5
5. CODE 128
6. QR CODE

#### **3.13.6 Print of Head Check**

The result of head check and head check pattern will be printed.

#### **3.13.7 Print Head and Sensor Check**

The result of head check, head check pattern and sensor information will be printed.

#### **3.13.8 Memory State**

Used memory size and available memory of user registration area will be printed.

1. True Type fonts
2. Formats
3. Graphics
4. PCX files
5. Designed fonts
6. Form overlay
7. BMP files

#### **3.13.9 Print of Supported Fonts**

The fonts used for test print are as follows.

1. OCR-A FONT(2X2)
2. OCR-B FONT(2X2)
3. OUTLINE FONT(100X100)
4. CG Times FONT(100X100)
5. CG Triumvirate FONT(100X100)
6. X20 FONT(2X2)
7. X21 FONT(2X2)
8. X22 FONT(2X2)
9. X23 FONT(2X2)
10. X24 22 FONT(2X2)
11. KANJI 16X16 FONT(2X2)
12. KANJI 24X24 FONT(2X2)
13. KANJI 22X22 FONT(2X2)
14. KANJI 32X32 FONT(2X2)
15. KANJI 40X40 FONT(2X2)
16. KANJI OUTLINE FONT(100X100))

#### **3.13.10 Print Test Pattern for Small Pitch Label**

Test pattern for adjusting pitch for small pitch label will be printed.

### 3.14 DEFAULT SETTING MODE

The printer can be reset to the default setting as in the factory preset.

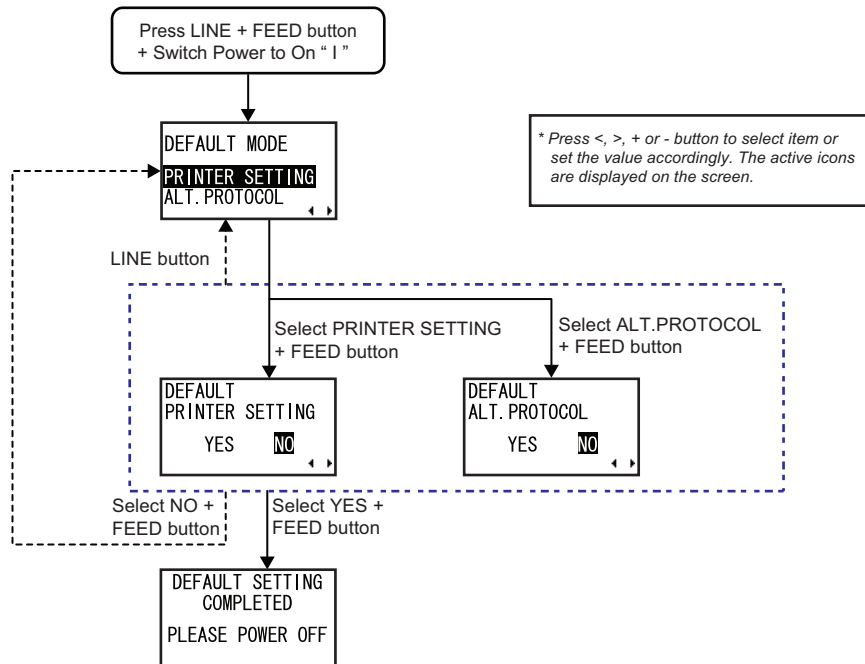

1. Make sure the Power of the printer is turned off (O).
2. While pressing the **LINE** button and the **FEED** button simultaneously, switch the Power to On (I).
3. The printer enters DEFAULT MODE.

DEFAULT SETTING MODE	
Menu	Description
	Select the item to be initialized. <b>PRINTER SETTING</b> : Initializing printer setting <b>ALT. PROTOCOL</b> : Initializing protocol code The initial setting is PRINTER SETTING. When PRINTER SETTING is selected, the printer displays the DEFAULT PRINTER SETTING confirmation menu. When ALT. PROTOCOL is selected, the printer displays the DEFAULT ALT. PROTOCOL confirmation menu.
	DEFAULT PRINTER SETTING confirmation menu. Selecting YES and pressing <b>FEED</b> button will initialize the printer setting. The initial setting is NO. If NO, it goes to DEFAULT MODE without initializing the printer setting.

### 3.14 DEFAULT SETTING MODE (Cont'd)

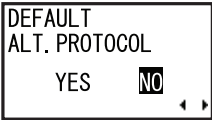
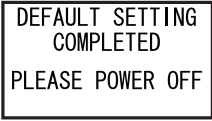
DEFAULT SETTING MODE	
Menu	Description
	DEFAULT ALT. PROTOCOL confirmation menu. Selecting YES and pressing <b>FEED</b> button will initialize protocol code. The initial setting is NO. If NO, it goes to DEFAULT MODE without initializing protocol code.
	This screen shows the completion of initialization and three beeps sound is heard. After this message is shown, power off the printer.

#### 3.14.1 Table of Default Settings

Item	Default value	
	HR212	HR224
ADJUSTMENT MODE		
PRINT SPEED	2.0 IPS	
PRINT DARKNESS	3	
DARKNESS RANGE	A	
PRIORITY SETTING	COMMAND	
PITCH	+0.00 mm	
OFFSET	+0.00 mm	
PRINT DARKNESS	50	
USER MODE		
PRINT SPEED	2.0 IPS	
PRINT DARKNESS	3	
PRINT OFFSET	V:+0000 H:+0000 dot	
ZERO SLASH	NO	
CHARACTER CODE	JIS CODE(NEC font/Ryobi font(0208)) SHIFT JIS (Ryobi font (0213))	
CHARACTER PITCH	FIXED	
INTERFACE MODE		
KEYPAD CONNECT	ENABLE	
DATA PORT	LAN	
SUB PORT	NONE	
EXTERNAL DEVICE	ENABLE	
RS-232C CONFIGURATION	Priority on selected interface settings	
BAUDRATE	19200bps	
PARITY BIT	NONE	
STOP BIT	1 BIT	
CHARACTER BIT	8 BIT	
LAN CONFIGURATION	Priority on selected interface settings	
IP RESOLUTION	DHCP	
RARP SETTING	DISABLE	
IP ADDRESS	0.0.0.0	
SUBNET MASK	0.0.0.0	
GATEWAY ADDRESS	0.0.0.0	
PORT NUMBER 1	1024	

### 3.14 DEFAULT SETTING MODE (Cont'd)

#### 3.14.1 Table of Default Settings (Cont'd)

Item	Default value	
	HR212	HR224
LAN CONFIGURATION	Priority on selected interface settings	
PORT NUMBER 2	1025	
PROTOCOL	STATUS4	
STATUS REPLY TIMING	ENQ	
RECEIVE BUFFER	MULTI	
ITEM NO CHECK	DISABLE	
BCC CHECK	DISABLE	
ADVANCED MODE		
DARKNESS RANGE	A	
PRINT TYPE	DISPENSER	
BACKFEED MOTION	AFTER	
SENSOR TYPE	GAP	
GAP POSITION	GAP2	
COMMAND ERROR DISPLAY	NO	
HEAD CHECK	ENABLE(NORMAL)	
EXTERNAL SIGNAL	DISABLE	
EXTERNAL SIGNAL TYPE	TYPE 4	
EXTERNAL REPRINT	DISABLE	
EXTERNAL DISP COMPLETE	DISABLE	
AUTO ONLINE	YES	
AUTO ONLINE FEED	YES	
FEED ON ERROR	YES	
SELECT LANGUAGE	ENGLISH	
PROTOCOL CODE	STANDARD	
LCD POWER SAVING MODE SETTING	00 MIN	
SEMBL MODE AUTO START	NO	

**3.14 DEFAULT SETTING MODE (Cont'd)**

3.14.1 Table of Default Settings (Cont'd)

Items	Default value	
	HR212	HR224
<b>SERVICE MODE</b>		
SENSOR LEVEL (GAP1)	50	
SLICE LEVEL (GAP1)	Auto setting	
SENSOR LEVEL (GAP2)	50	
SLICE LEVEL (GAP2)	Auto setting	
SENSOR LEVEL (GAP3)	50	
SLICE LEVEL (GAP3)	Auto setting	
SENSOR LEVEL (GAP4)	50	
SLICE LEVEL (GAP4)	Auto setting	
SENSOR LEVEL (I-MARK)	50	
SLICE LEVEL (I-MARK)	Auto setting	
PITCH (GAP1)	+00 dot	
PITCH (GAP2)	+00 dot	
PITCH (GAP3)	+00 dot	
PITCH (GAP4)	+00 dot	
PITCH (I-MARK)	+00 dot	
OFFSET (GAP1)	+00 dot	
OFFSET (GAP2)	+00 dot	
OFFSET (GAP3)	+00 dot	
OFFSET (GAP4)	+00 dot	
OFFSET (I-MARK)	+00 dot	
BACKFEED (GAP1)	+00 dot	
BACKFEED (GAP2)	+00 dot	
BACKFEED (GAP3)	+00 dot	
BACKFEED (GAP4)	+00 dot	
BACKFEED (I-MARK)	+00 dot	
PRIORITY SETTING	COMMAND	
SET PASSWORD	OFF	
TOTAL QTY DISPLAY	YES	
REPRINT	NO	
EXTERNAL DISP PIN SELECT	9PIN	
<b>FACTORY MODE</b>		
LIFE COUNTER	0	
HEAD COUNTER	0	
DISPENSER COUNTER	0	
<b>OTHERS</b>		
TEAR OFF TOP POS	+0.00 mm	

### 3.15 MAINTENANCE MODE

In Maintenance mode, you can further access to Service mode for more printer configuration.

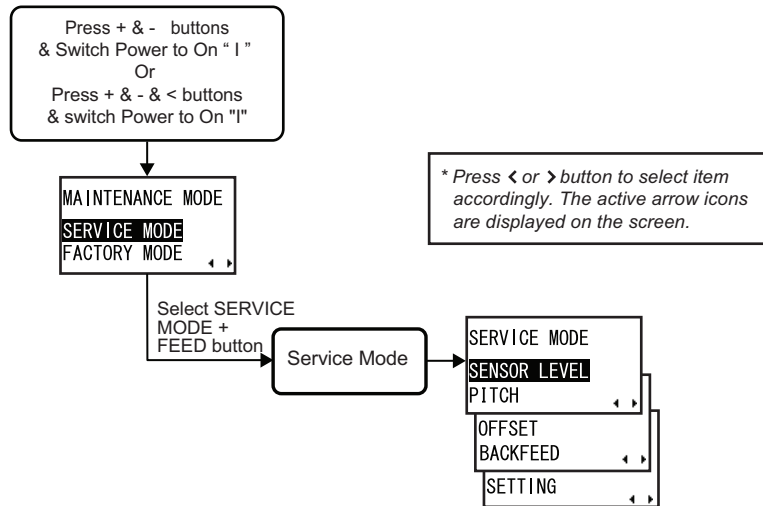

1. Make sure the Power of the printer is turned off (O).
2. While pressing the + and - buttons simultaneously, switch the Power to On (I). The printer enters MAINTENANCE mode.

**Note:**

You may also access to MAINTENANCE mode by pressing the + and - buttons, and < arrow buttons simultaneously, switch the Power to On (I).

3. Press <, > **arrow** buttons to select SERVICE MODE and then press **FEED** button to enter to the selected mode.

**Note:**

Please note that FACTORY MODE is strictly for SATO authorised service personnel use. Any mis-adjustment or setting may disrupt the performance of the printer and may cause malfunction.

### 3.16 SERVICE MODE

In SERVICE MODE menu, you can program various dimensional settings of the printer. Press **<**, **>** arrow buttons to select SENSOR LEVEL, PITCH, OFFSET, BACKFEED or SETTING, and then press **FEED** button to enter to the selected mode. Refer to the following flowcharts of the all setting and LCD display menus available in SERVICE MODE.

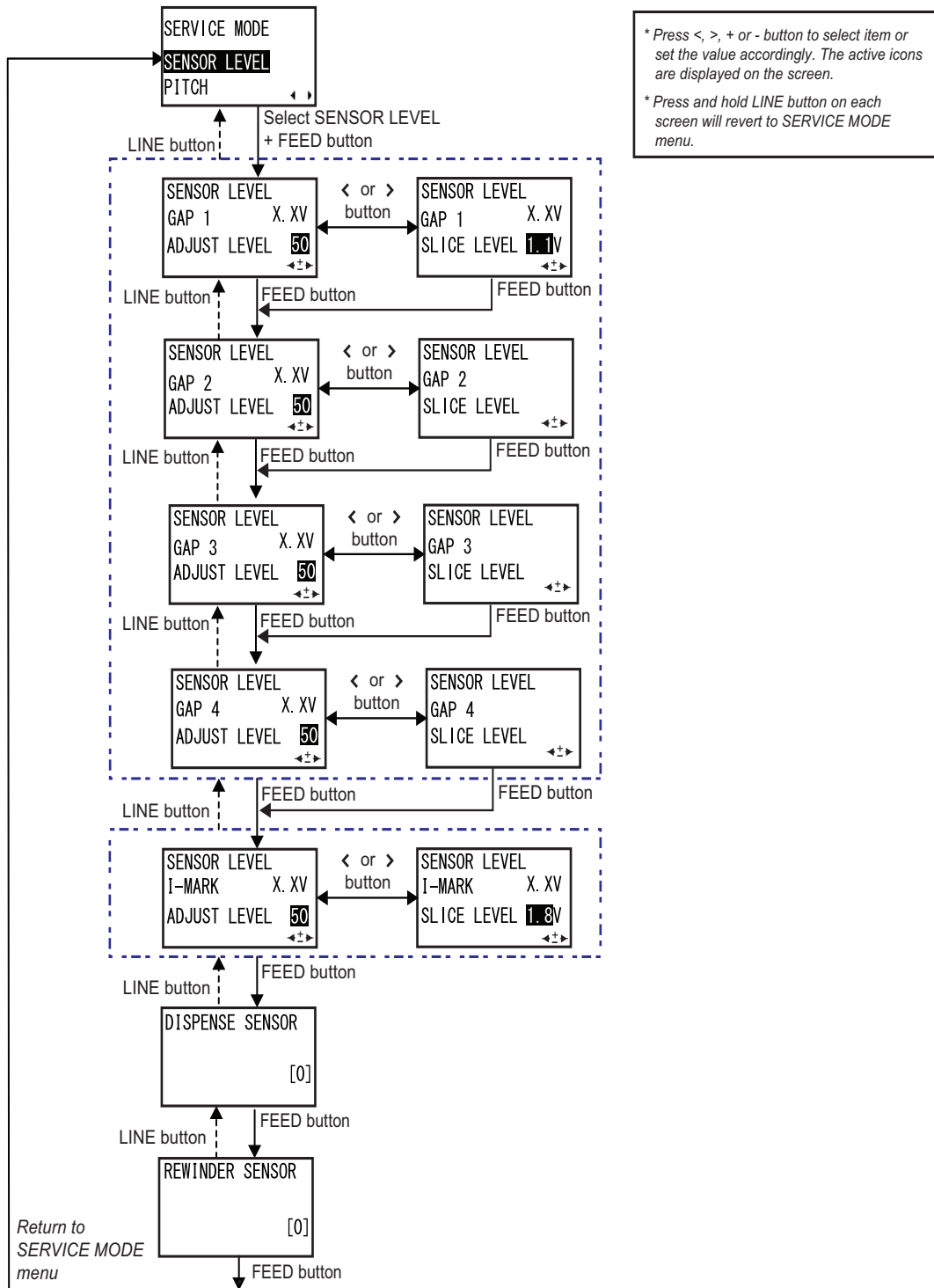

#### 3.16.1 Overview of Sensor Level adjustment in Service Mode



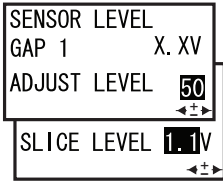
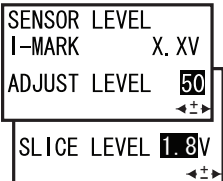

**3.16 SERVICE MODE (Cont'd)**

1. When SENSOR LEVEL is selected, press the **FEED** button repeatedly will switch to the next setting options as shown above. To return to the previous setting option, press **LINE** button. To return to SERVICE MODE screen, press and hold **LINE** button.
2. When the desired setting option is displayed, press **<, > arrow** buttons to select the item or **+ / -** buttons to set the value and then press **FEED** button to save the setting.

SENSOR LEVEL MODE	
Menu	Description
	<p>Displaying the current level of gap sensor on the upper part of the display. The number beside GAP shows the position of the GAP sensor, ascending from the center to the right of the printer. Adjust the sensor level offset with <b>+ / -</b> buttons. This offset determined how soon the sensor responds to an oncoming gap. The adjustment range is between 0 and 99 and is shown on the bottom line of the display. The default setting is 50.</p> <p>Press <b>&lt;, &gt; arrow</b> buttons to save the setting and switch to slice level display. The slice level is calculated automatically and displayed on the bottom line. Adjust the slice level by pressing <b>+ / -</b> buttons. The input range is between 0.0 and 3.2. (adjustable in increments of 0.1)</p> <p><b>Note:</b> The slice level is automatically set by firmware when the value is set to 0.0. Press <b>FEED</b> button to save the setting and proceed to the next screen.</p>
	<p>Displaying the current level of I-Mark sensor on the upper part of the display. Adjust the sensor level offset with <b>+ / -</b> buttons. This offset determined how soon the sensor responds to an oncoming I-Mark. The adjustment range is between 0 and 99 and is shown on the bottom line of the display. The default setting is 50.</p> <p>Press <b>&lt;, &gt; arrow</b> buttons to save the setting and switch to slice level display. The slice level is calculated automatically and displayed on the bottom line. Adjust the slice level by pressing <b>+ / -</b> buttons. The input range is between 0.0 and 3.2. (adjustable in increments of 0.1)</p> <p><b>Note:</b> The slice level is automatically set by firmware when the value is set to 0.0. Press <b>FEED</b> button to save the setting and proceed to the next screen.</p>
	<p>Displaying the current state of dispensing sensor. [0] indicates no label [1] indicates with label.</p>
	<p>Displaying the current state of rewinding sensor. [1] indicates the rewinder for the liner (backing paper) is full.</p>

### 3.16 SERVICE MODE (Cont'd)

#### 3.16.2 Pitch adjustment in Service Mode

This is a fine tuning added on to the Pitch position set in Adjustment mode or Test Print mode.

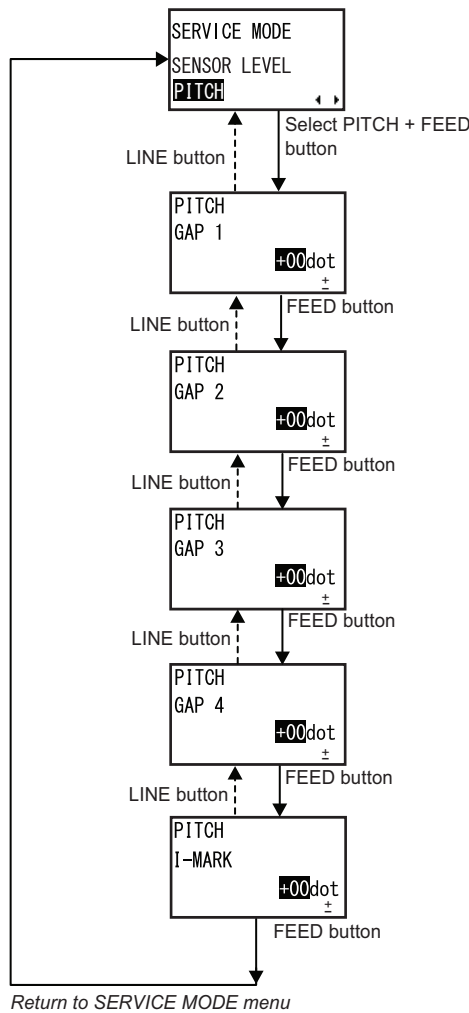

\* Press <, >, + or - button to select item or set the value accordingly. The active icons are displayed on the screen.  
\* Press and hold LINE button on each screen will revert to SERVICE MODE menu.

1. When PITCH is selected, press the **FEED** button repeatedly will switch to the next setting options as shown above. To return to the previous setting option, press **LINE** button. To return to SERVICE MODE screen, press and hold **LINE** button.
2. When the desired setting option is displayed, press + / - buttons to set the value and then press **FEED** button to save the setting.

### 3.16 SERVICE MODE (Cont'd)

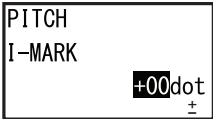
PITCH OFFSET MODE	
Menu	Description
 <p>PITCH GAP 1 +00dot ±</p>	<p>Adjusting the print start positions for four GAP sensors. The number beside GAP shows the position of the GAP sensor, ascending from the center to the right of the printer.</p> <p>Use <b>+</b> / <b>-</b> buttons to change the value.</p> <p>“+”: Moves print position forward to feed direction. “-”: Moves print position backward to feed direction.</p> <p>Setting range is <math>\pm 0 - 72</math>dot. The default setting is “+00dot”.</p> <p>Press <b>FEED</b> to proceed to each GAP sensor to complete the settings.</p>
 <p>PITCH I-MARK +00dot ±</p>	<p>Adjusting print start position for I-MARK sensor.</p> <p>Use <b>+</b> / <b>-</b> buttons to change the value.</p> <p>“+”: Moves print position forward to feed direction. “-”: Moves print position backward to feed direction.</p> <p>Setting range is <math>\pm 0 - 72</math>dot. The default setting is “+00dot”.</p> <p>Pressing <b>FEED</b> save the setting and return to service mode menu.</p>

### 3.16 SERVICE MODE (Cont'd)

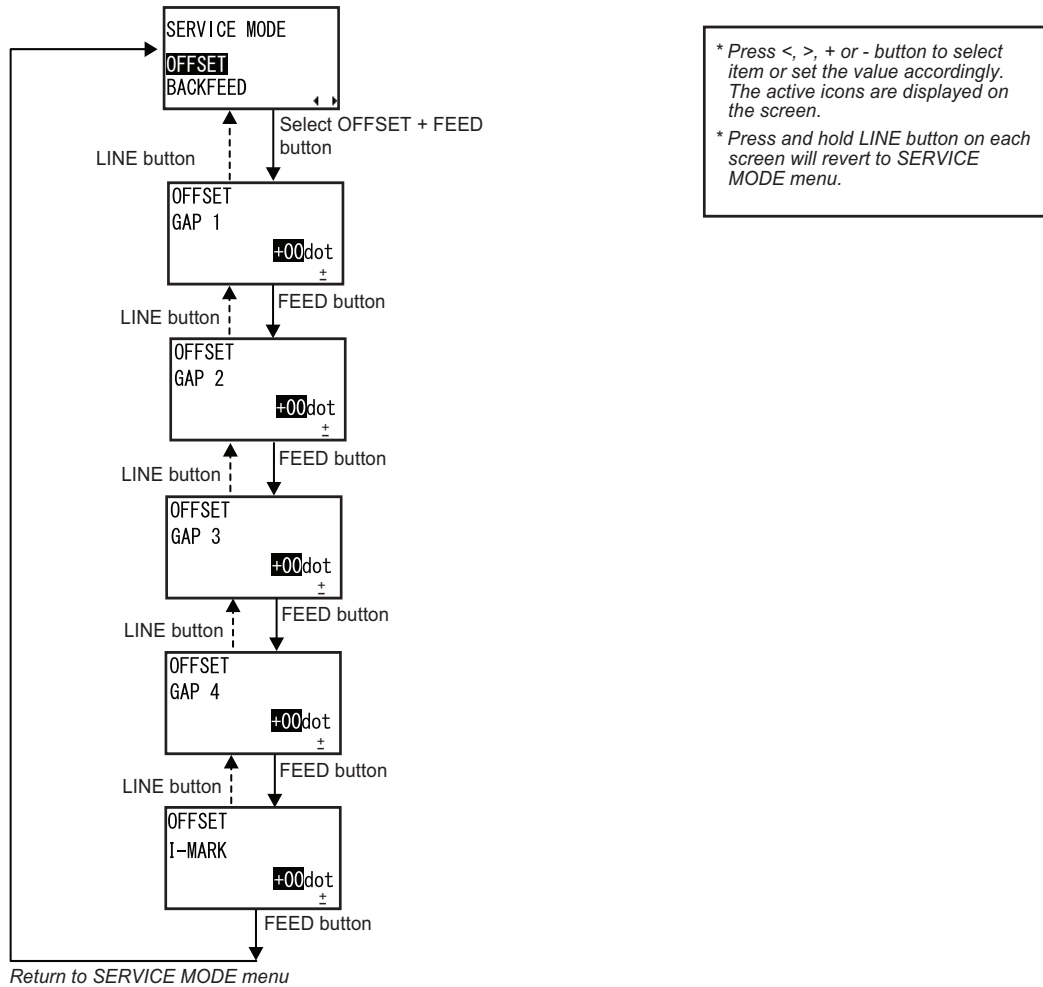

#### 3.16.3 Dispense or Tear off offset adjustment in Service Mode

This is a fine tuning added on to the Offset position set in Adjustment mode or Test Print mode.



1. When OFFSET is selected, press the **FEED** button repeatedly will switch to the next setting options as shown above. To return to the previous setting option, press **LINE** button. To return to SERVICE MODE screen, press and hold **LINE** button.
2. When the desired setting option is displayed, press + / - buttons to set the value and then press **FEED** button to save the setting.

## 3.16 SERVICE MODE (Cont'd)

DISPENSE or TEAR OFF OFFSET MODE	
Menu	Description
	<p>Adjusting the stop positions of four GAP sensors for dispense or tear off. The number beside GAP shows the position of the GAP sensor, ascending from the center to the right of the printer.</p> <p>Use <b>+</b> / <b>-</b> buttons to change the value.</p> <p>“+”: Moves stop position forward to feed direction. “-”: Moves stop position backward to feed direction.</p> <p>Setting range is <math>\pm 0 - 72\text{dot}</math>. The default setting is “+00dot”.</p> <p>Press <b>FEED</b> to proceed to each GAP sensor to complete the settings.</p>
	<p>Adjusting stop position of I-MARK sensor for dispense or tear off.</p> <p>Use <b>+</b> / <b>-</b> buttons to change the value.</p> <p>“+”: Moves stop position forward to feed direction. “-”: Moves stop position backward to feed direction.</p> <p>Setting range is <math>\pm 0 - 72\text{dot}</math>. The default setting is “+00dot”.</p> <p>Press <b>FEED</b> to save the setting and return to service mode menu.</p>

### 3.16 SERVICE MODE (Cont'd)

#### 3.16.4 Backfeed Offset adjustment in Service Mode

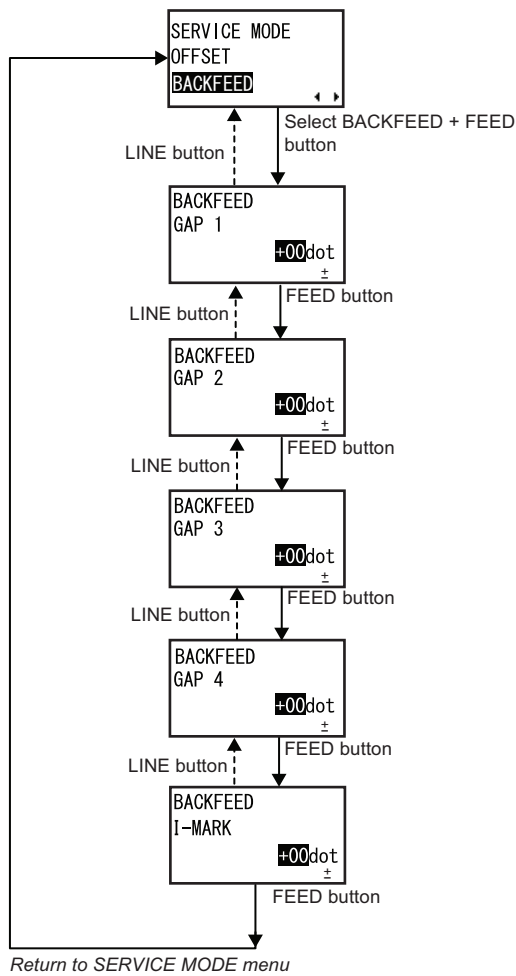



\* Press <, >, + or - button to select item or set the value accordingly. The active icons are displayed on the screen.

\* Press and hold LINE button on each screen will revert to SERVICE MODE menu.

1. When BACKFEED is selected, press the **FEED** button repeatedly will switch to the next setting options as shown above. To return to the previous setting option, press **LINE** button. To return to SERVICE MODE screen, press and hold **LINE** button.
2. When the desired setting option is displayed, press + / - buttons to set the value and then press **FEED** button to save the setting.

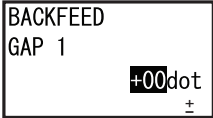
## 3.16 SERVICE MODE (Cont'd)

BACKFEED OFFSET MODE	
Menu	Description
 <p>BACKFEED GAP 1 +00dot ±</p>	<p>Adjusting the backfeed value for four GAP sensors. The number beside GAP shows the position of the GAP sensor, ascending from the center to the right of the printer.</p> <p>Use <b>+ / -</b> buttons to change the value.</p> <p>“+”: Increases backfeed value. “-”: Decreases backfeed value.</p> <p>Setting range is <math>\pm 0 - 72</math>dot. The default setting is “+00dot”.</p> <p>Press <b>FEED</b> to proceed to each GAP sensor to complete the settings.</p>
 <p>BACKFEED I-MARK +00dot ±</p>	<p>Adjusting backfeed value for I-MARK sensor.</p> <p>Use <b>+ / -</b> buttons to change the value.</p> <p>“+”: Increases backfeed value. “-”: Decreases backfeed value.</p> <p>Setting range is <math>\pm 0 - 72</math>dot. The default setting is “+00dot”.</p> <p>Press <b>FEED</b> to save the setting and return to service mode menu.</p>

### 3.16 SERVICE MODE (Cont'd)

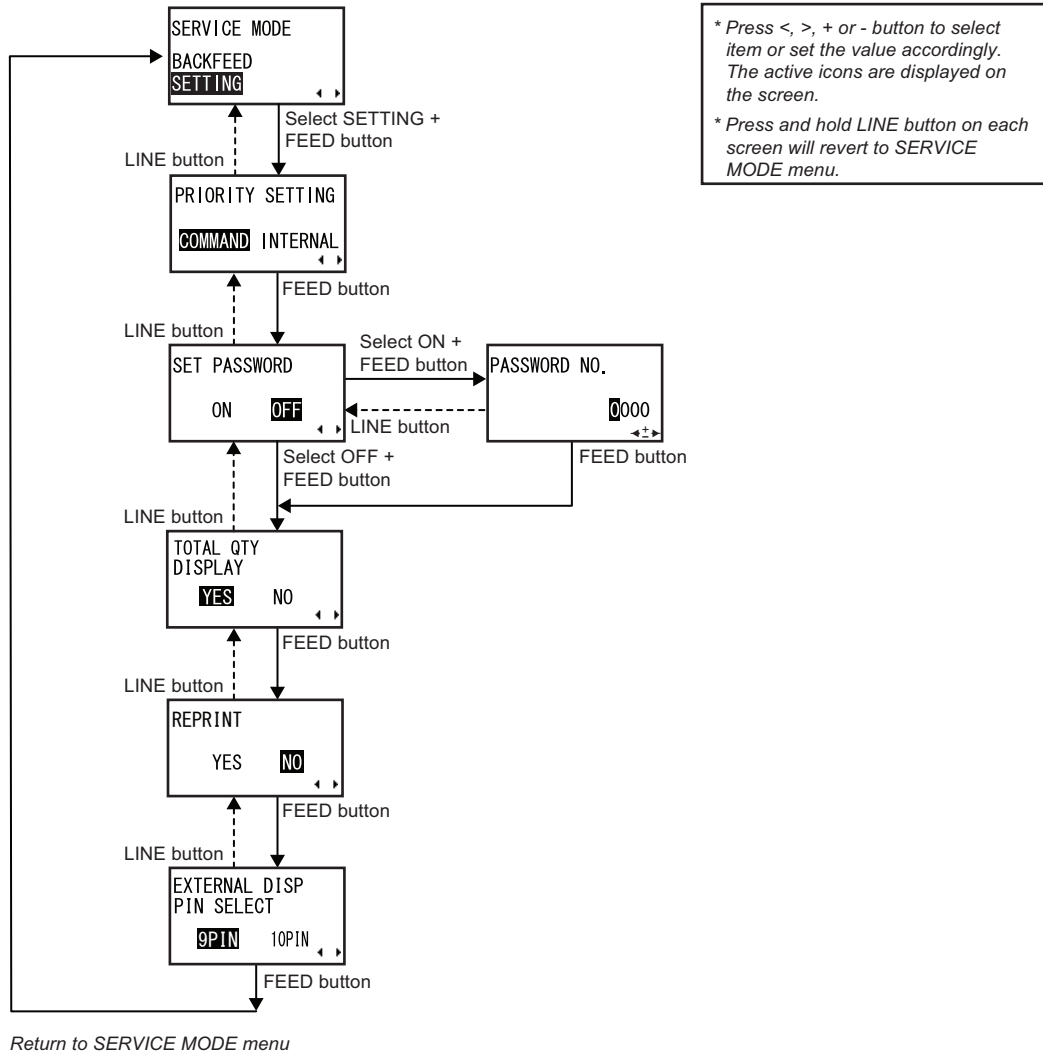

#### 3.16.5 Overview of Setting menu in Service Mode



1. When SETTING is selected, press the **FEED** button repeatedly will switch to the next setting options as shown above. To return to the previous setting option, press **LINE** button. To return to SERVICE MODE screen, press and hold **LINE** button.
2. When the desired setting option is displayed, press <, > **arrow** buttons to select the item or press +/- buttons to set the value and then press **FEED** button to save the setting

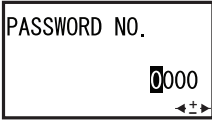
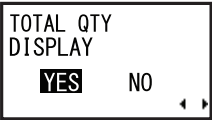
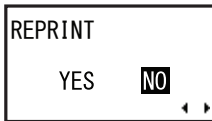
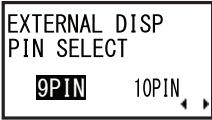

## 3.16 SERVICE MODE (Cont'd)

SETTING MODE	
Menu	Description
	<p>Enabling/Disabling the command priority for system setting.</p> <p><b>COMMAND:</b> Priority is given to certain system commands that was sent to the printer and overwrite the configuration done by the LCD operation panel. This priority assignment affects the settings for print darkness, print speed, start point correction, operation mode, printer type, print method and sensor types.</p> <p><b>INTERNAL:</b> The above mentioned printer configuration set by the LCD operation panel is not replaced by the sent command.</p> <p>The initial setting is COMMAND.</p>
	<p>Enabling/Disabling password entry to various modes.</p> <p><b>ON:</b> To enable password entry.</p> <p><b>OFF:</b> To disable password entry.</p> <p>Requiring the password when entering the following modes.</p> <ul style="list-style-type: none"> <li>•USER MODE</li> <li>•INTERFACE MODE</li> <li>•CARTRIDGE MODE</li> <li>•ADVANCED MODE</li> <li>•HEX DUMP MODE</li> </ul> <p>The initial value is OFF.</p>
	<p>Setting password to go to various modes.</p> <p>Press +/- buttons to key in the number and press &lt;, &gt; <b>arrow</b> buttons to move the cursor to next digit. Press <b>FEED</b> button to enter the setting.</p> <p>Set the password in four digits.</p> <p>The initial value is 0000.</p>
	<p>Setting the display of print quantity on the normal mode screen (ONLINE/OFFLINE).</p> <p><b>YES:</b> Showing the total print quantity and the current print quantity.</p> <p><b>NO:</b> Showing print quantity.</p> <p>The initial setting is YES.</p>
	<p>Selecting reprint of previous label.</p> <p><b>YES:</b> Reprints previous label.</p> <p><b>NO:</b> Does not perform reprinting.</p> <p>In online mode when YES is set, pressing <b>FEED</b> button will print the previous label.</p> <p>The initial setting is NO.</p>
	<p>Selecting external output pin number for output dispense waiting signal.</p> <p><b>9PIN:</b> 9PIN is changed to output by SW3 on CONT PCB.</p> <p><b>10PIN:</b> 10PIN is changed to output by SW3 on CONT PCB.</p> <p>The initial setting is 9PIN.</p> <p>Valid when ENABLE is selected in EXTERNAL DISP screen under Advanced mode.</p>

### 3.17 DOWNLOAD MODE

This download feature allows the operator to download data (firmware, font/logo, True type font), from the host computer and write in the Flash ROM memory. When downloading is complete, the LCD screen will return to the original display after three seconds. If an error occurs, a DOWNLOAD DATA ERROR will display and identify the reason.

**⚠ CAUTION:**

- Downloading firmware will initialize all the previous settings (USER MODE, ADVANCED MODE). Write down its setting details or keep a copy of FACTORY TEST PRINT for your information in case you wish to maintain the same settings in the future.
- Do not turn the power on/off while downloading. This may damage the CONT board (main PCB).

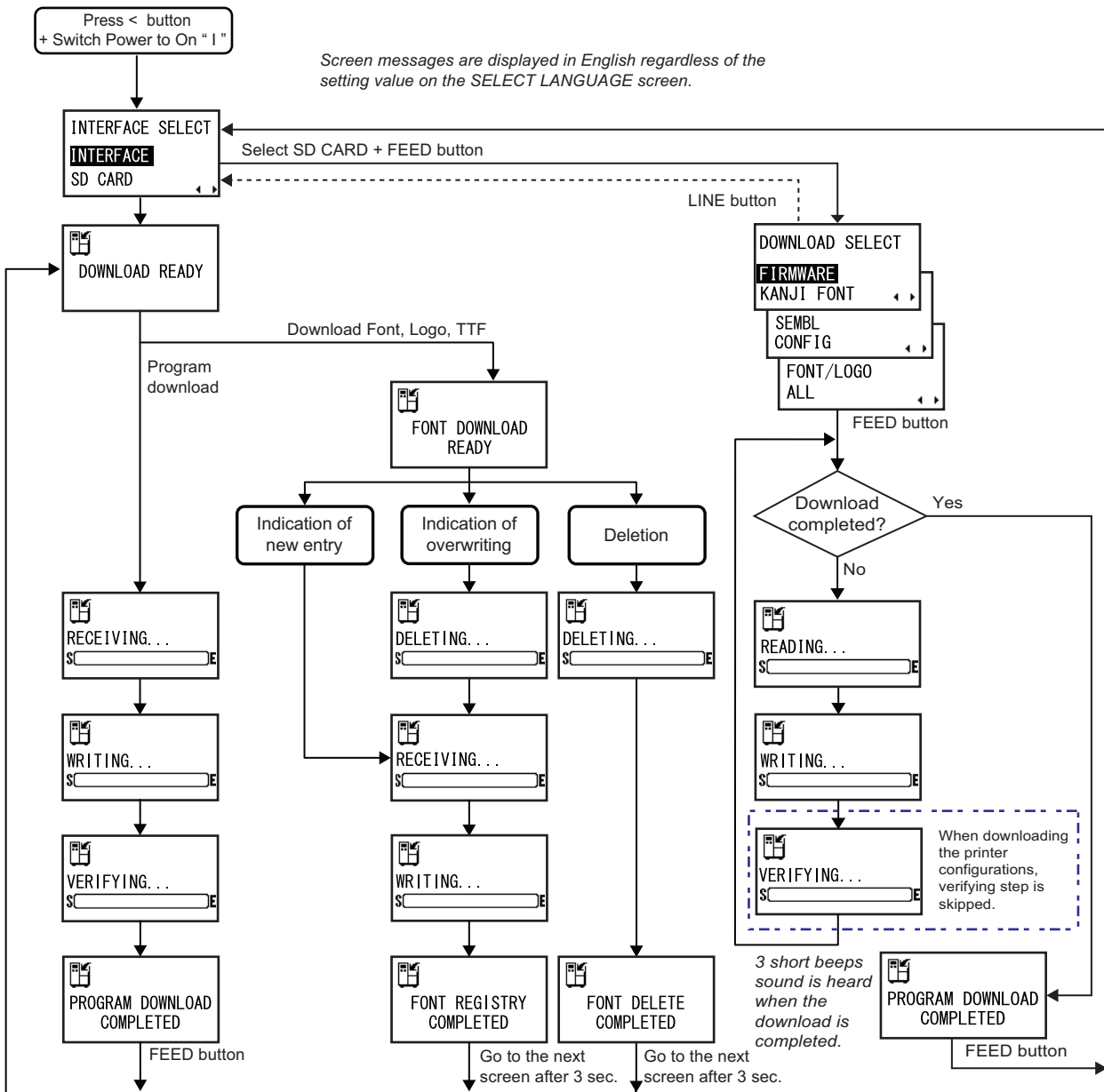



### 3.17 DOWNLOAD MODE (Cont'd)

Preparation:



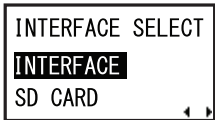

When downloading from the host computer through the connected interface, ensure the interface is connected and is set as DATA PORT in the INTERFACE MODE.

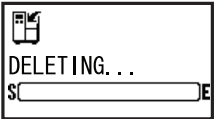
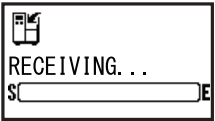
When downloading from the SD card, load the appropriate SD card to the printer.

1. Make sure the Power of the printer is turned off (O).
2. While pressing the < **arrow** button, switch the Power to On (I).
3. The printer enters INTERFACE SELECT mode. Select INTERFACE or SD CARD and press **FEED**.
4. The printer enters DOWNLOAD READY mode.
5. Send in the data for downloading from the host computer to the printer.

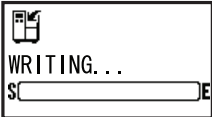
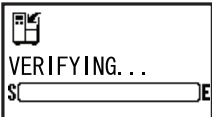
DOWNLOAD MODE	
Menu	Description
	<p>Selecting download method.</p> <p><b>INTERFACE:</b> Downloading the program from the interface.</p> <p><b>SD CARD:</b> Downloading the program from SD card.</p> <p>The initial setting is INTERFACE.</p> <p>For downloading data via the interface using SATO Utilities Tool application on the host, consult SATO technical support center.</p>
	<p>Waiting to receive download data.</p> <p>This screen displays only when INTERFACE SELECT is set to INTERFACE. The printer waits to receive the data from the interface selected on the DATA PORT screen under the interface mode.</p> <p>The following data will be received from the PC and written to main ROM.</p> <p>(1) Firmware data (2) Font / Logo data (3) TRUETYPE font</p> <p>When Firmware data is received, it goes to RECEIVING screen.</p> <p>When Font, Logo and TRUETYPE font are received, it goes to FONT DOWNLOAD READY screen.</p>
	<p>Waiting to receive font data.</p> <p>This screen displays only when INTERFACE SELECT is set to INTERFACE. When downloading the font for the first time, it goes to RECEIVING... screen. To overwrite or delete font data, it goes to DELETING... screen.</p>
	<p>Deleting font data.</p> <p>The gauge shown on the lower portion of screen indicates deleting status of download data.</p> <p>To overwrite font data after deleting the font data, it goes to RECEIVING... screen.</p> <p>To delete the font data, it goes to FONT DELETE COMPLETED screen.</p>
	<p>Receiving download data.</p> <p>The gauge shown on the lower portion of screen indicates data reception status.</p> <p>After receiving the download data, it goes to WRITING... screen.</p>

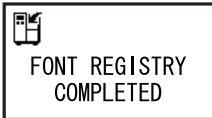
**3.17 DOWNLOAD MODE (Cont'd)**

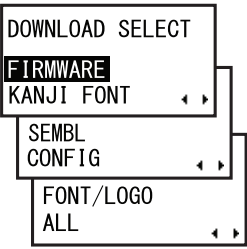
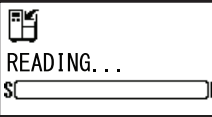
DOWNLOAD MODE	
Menu	Description
	<p>Writing download data. The gauge shown on the lower portion of screen indicates writing status of download data. After writing the download font, it goes to FONT REGISTRY COMPLETED screen. After writing the download data, it goes to VERIFYING... screen.</p>
	<p>Verifying download data. The gauge shown on the lower portion of screen indicates verification status of download data. After verifying the download data, it goes to PROGRAM DOWNLOAD COMPLETED screen.</p>
	<p>Completion of download. Emitting three short beeps when program download is completed. If downloading from INTERFACE, press <b>FEED</b> button will go back to DOWNLOAD READY screen. If downloading from SD CARD, press <b>FEED</b> button will return to INTERFACE SELECT screen.</p>
	<p>Completion of font data registry. Emitting three short beeps when font registry is completed. Goes to DOWNLOAD READY screen automatically three seconds later.</p>
	<p>Completion of font data deletion. Emitting three short beeps when font delete is completed. Goes to DOWNLOAD READY automatically three seconds later.</p>
	<p>Selecting the item to be downloaded. This screen displays only when INTERFACE SELECT is set to SD CARD. <b>FIRMWARE:</b> Downloading “Firmware”, “Kanji font”, “Kanji outline font”. <b>KANJI FONT:</b> Downloading “Kanji font”, “Kanji outline font”. <b>SEMBL:</b> SEMBL program data <b>CONFIG:</b> Printer configuration <b>FONT/LOGO:</b> Font/ Logo data <b>ALL:</b> All The initial setting is FIRMWARE.</p>
	<p>Reading in the download data. The gauge shown on the lower portion of screen indicates data reception status. After receiving the data, it goes to WRITING... screen.</p>

### 3.17 DOWNLOAD MODE (Cont'd)

List of items for downloading:

Yes: Available / No: Not available

Item	SD Card	Interface	Note
Firmware	Yes	Yes	
Font	Yes	Yes	
LCD data	Yes	Yes	
Kanji outline font	Yes	Yes	
Kanji font	Yes	Yes	
Printer setting information	Yes	No	
SEMBL program	Yes	No	Uploaded files only
Font/Logo	Yes	Yes	Interface: Files created by [Download font creation utility] or [Download logo file creation tool] only. SD card: Uploaded files only.
Receive buffer	No	No	
STATUS5 history	No	No	
All	Yes	No	All items marked "Yes"

#### Notes:

1. If the same name file is present when downloading, the file is overwritten.
2. When the items are selected and the target file doesn't exist, the item cannot be selected.
3. "CONFIG", size of "FONT/LOGO" varies depending on head density. Don't download between the printers having different head densities.
4. When downloading Kanji font, if NEC font and Ryobi font are saved in SD card, Ryobi font will be downloaded. When there are two type of Ryobi font; "JIS X 0208" support file and "JIS X 0213" support file, only "JIS X 0208" is downloaded.
5. Download of "FONT/LOGO" created by tool ([Download font creation utility] or [Download logo file creation tool]) is only available through Interface. You cannot download the data after copying to SD card. The files uploaded to SD card cannot be loaded to the tool.

### 3.18 UPLOAD MODE

This upload feature allows the operator to upload data (firmware, font/logo, True type font, SEMBL, configuration, status5 log), from the printer and write to the SD card. When uploading is complete, the LCD screen will return to the original display after three seconds. If an error occurs, error message will display and identify the reason.

 **CAUTION:**

- Do not turn the power on/off while uploading. This may damage the SD card.

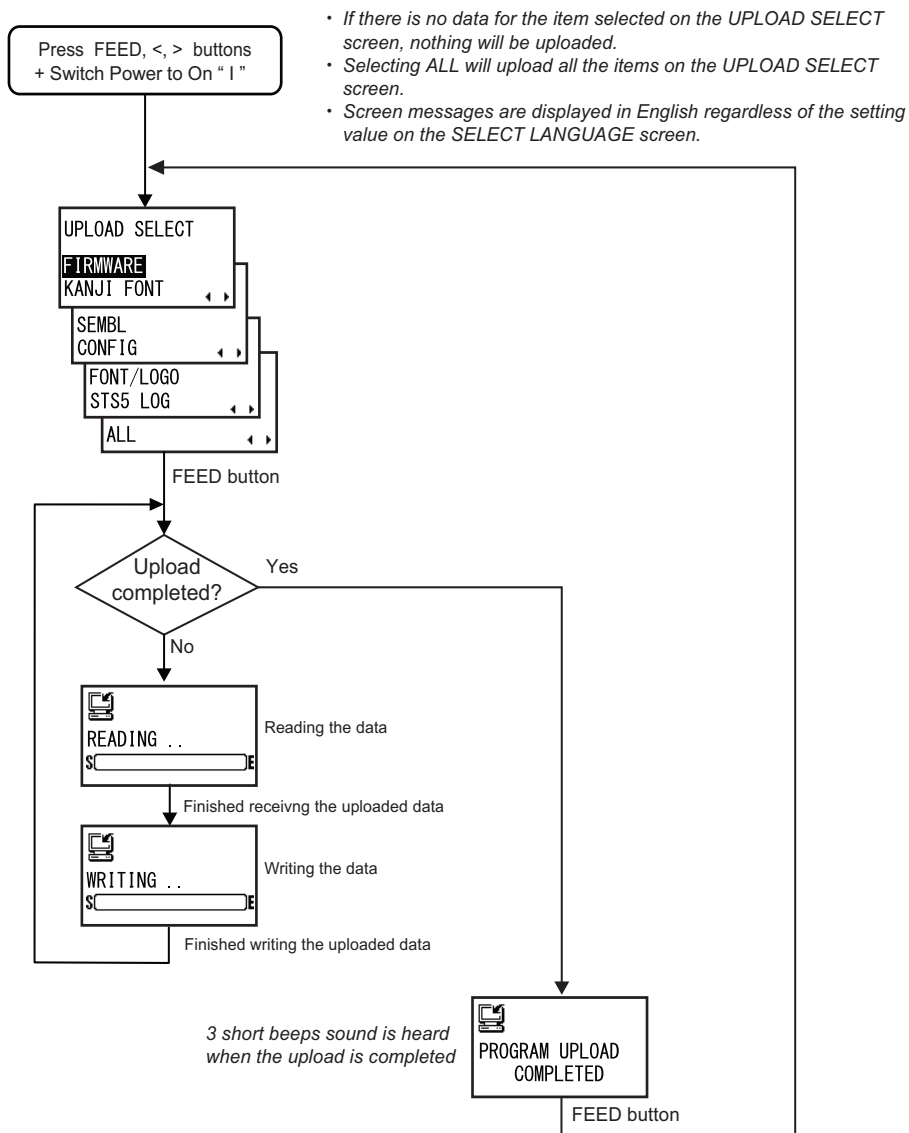

### 3.18 UPLOAD MODE (Cont'd)

Preparation:

Load the SD card to the printer.

1. Make sure the Power of the printer is turned off (O).
2. While pressing the **FEED**, <and > arrow buttons simultaneously, switch the Power to On (I).
3. The printer enters UPLOAD SELECT screen. Select the desired item and press **FEED** button.

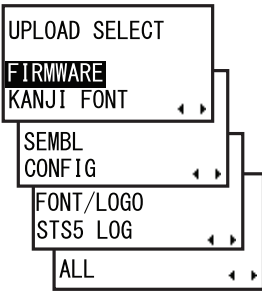
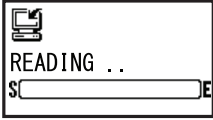
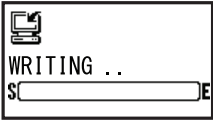
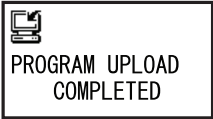
DOWNLOAD MODE	
Menu	Description
	<p>Selecting the item to be uploaded.</p> <p><b>FIRMWARE:</b> Uploading “Firmware”, “Kanji font”, “Kanji outline font”.</p> <p><b>KANJI FONT:</b> Uploading “Kanji font”, “Kanji outline font”.</p> <p><b>SEMBL:</b> SEMBL program data</p> <p><b>CONFIG:</b> Printer configuration</p> <p><b>FONT/LOGO:</b> Font/ Logo data</p> <p><b>STS5 LOG:</b> Status5 log</p> <p><b>ALL:</b> All</p> <p>The initial setting is FIRMWARE.</p>
	<p>Reading in the data for upload.</p> <p>The gauge shown on the lower portion of screen indicates data reception status.</p> <p>After receiving the data, it goes to WRITING... screen.</p>
	<p>Writing the data for upload.</p> <p>The gauge shown on the lower portion of screen indicates writing status of the data.</p>
	<p>Completion of upload.</p> <p>Emitting three short beeps when program upload is completed. Press <b>FEED</b> button to go back to UPLOAD SELECT screen.</p>

### 3.18 UPLOAD MODE (Cont'd)

---

List of items for uploading:

Yes: Available / No: Not available

Item	SD Card	Interface	Note
Firmware	Yes	No	
Font	Yes	No	
LCD data	Yes	No	
Kanji outline font	Yes	No	
Kanji font	Yes	No	NEC font is invalid.
Printer setting information	Yes	No	
SEMBL program	Yes	No	
Font/Logo	Yes	No	
Receive buffer	No	No	Received data saving mode only.
STATUS5 history	Yes	No	
All	Yes	No	All above items except for receive buffer, and FRAM

**Notes:**

1. When folder is not found, folder is created automatically.
2. When SD card is in the state of “write protection”, it becomes error. Upload data after clear write protection.
3. When there aren't enough area in SD card, error occurs during uploading.
4. Printer doesn't have calendar, so that firmware release data is given to the uploaded file as creation date.



# 4

## CLEANING AND MAINTENANCE

---

This section provides information on user maintenance for the HR2 series printer.

The following information is covered here:

- 4.1 Cleaning The Print Head, Platen and Rollers
- 4.2 How To Clean The Printer (Cleaning Kit)
- 4.3 How To Clean The Printer (Cleaning Sheet)
- 4.4 Adjusting Print Quality



### **Caution**

- When cleaning the print head, bear in mind that the print head and its surroundings may be hot. Wait until the printer cools down before proceeding to clean the printer.
- Be sure to turn off the power before cleaning.
- The suggested cleaning schedules here are just guidelines. If necessary, clean as appropriate, depending on the degree of contamination.
- Use a cleaning pen, cotton swab or cotton cloth, from an approved cleaning kit, to clean the printer units.
- Use only soft, lint-free materials for cleaning. Avoid using hard objects for the cleaning process, as they will damage the components.

## 4.1 CLEANING THE PRINT HEAD, PLATEN AND ROLLERS

---

The print head not only generates printouts of barcodes, but also graphics and text. To produce optimal printing, it must be kept clean in spite of the dirt and adhesive that constantly accumulates on its print surface. Furthermore, dirt can accumulate along the label path, affecting parts like sensors and guides, and reducing their performance.

Therefore, it is important to clean these important components periodically. The printer cleaning kit and cleaning sheets can be purchased from your authorized SATO representative.

### When to clean with a cleaning kit

- ◆ For the printer head, platen roller, paper sensor, and label guide: clean after using up every other roll of media.
- ◆ For other parts: clean after finishing every six rolls of media.

### When to clean with the cleaning sheet

- ◆ For print head: clean after using every six rolls of media, or when you find any burned glaze on the surface of the print head.

## 4.2 HOW TO CLEAN THE PRINTER (CLEANING KIT)

---

If you are using a carbon ribbon, be sure to remove it before cleaning. Follow the instructions supplied with the cleaning kit. Use the items to clean the following parts.

1. Before starting, get ready an approved cleaning kit from your SATO representative. Make sure the printer is powered off, and remove the power cable.
2. Lift up the **top cover**.  
The **print head** is now accessible.
3. Wipe off the dirt on the **print head** using a cleaning pen or a cotton swab dabbed with the cleaning liquid. (See figure on the right)

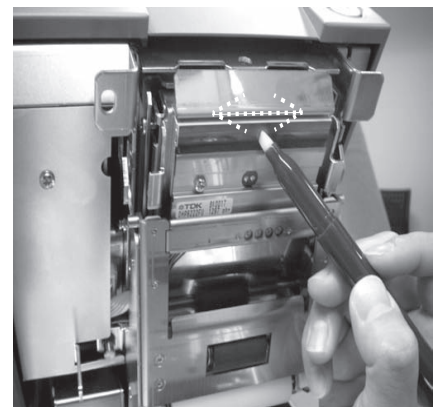
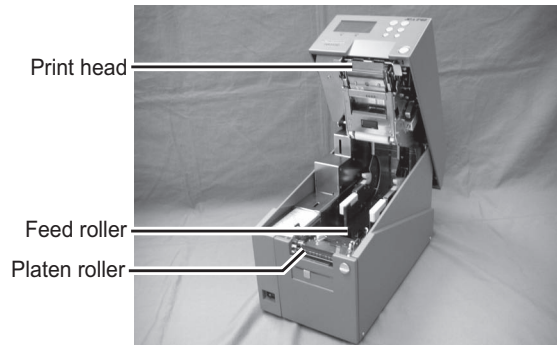

### 4.2 HOW TO CLEAN THE PRINTER (CLEANING KIT) (Cont'd)

---

4. Wipe off the dirt on the **feed roller** using a cleaning cloth dabbed with the cleaning liquid. (See figure on the right).

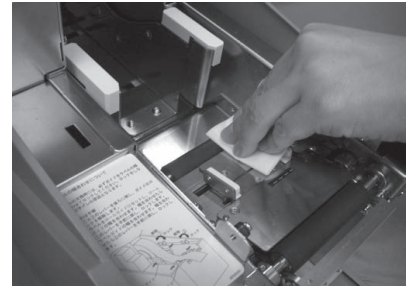

5. Wipe off the dirt on the **platen roller** using a cleaning cloth dabbed with the cleaning liquid. (See figure on the right).

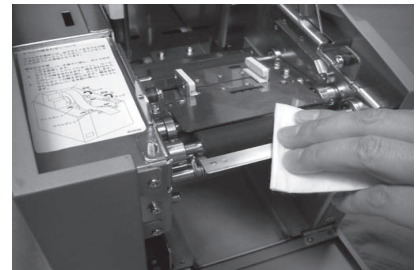

### 4.3 HOW TO CLEAN THE PRINTER (CLEANING SHEET)

---

If certain stains on the print head cannot be removed easily with cotton swabs dabbed in cleaning solution, the cleaning sheet is used for clearing such stubborn debris on the print head.

1. Make sure the printer is powered off and remove the power cable.
2. Lift up the **top cover**. The **print head** is now accessible.
3. Remove the media and the ribbon.
4. Put the head **cleaning sheet** between the **print head** and the **platen roller**. The coarse side of the cleaning sheet should face the surface of the **print head elements**.
5. Close the **top cover**. The print head should lock into place firmly.
6. Using both hands, pull the **cleaning sheet** outwards, toward your body. This will remove any dirt stuck to the print head.

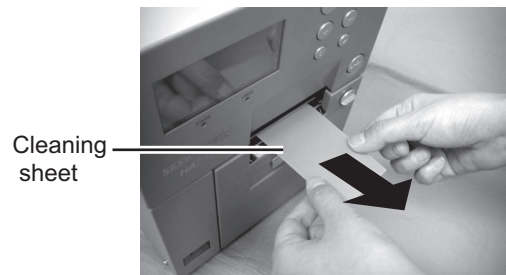

### 4.3 HOW TO CLEAN THE PRINTER (CLEANING SHEET) (Cont'd)

---

7. When the cleaning sheet has been removed, perform steps 4 to 6 to repeat the cleaning procedure one or two more times.
8. When no more additional dirt appears on the cleaning sheet after it has been pulled out, you can stop cleaning with the sheet.
9. Use the cleaning pen from the cleaning kit to gently remove any remaining dirt from the print head.

### 4.4 ADJUSTING PRINT QUALITY

---

Print quality can be optimized with regular cleaning and maintenance of the print head and components along the label path. Additionally, you can fine-tune print quality by adjusting print darkness and print speed settings.

#### 4.4.1 Adjusting Print Darkness

This adjustment allows the user to control (within a specified range) the amount of power applied to the individual print head heat elements. It is important to find a proper print darkness level based on your particular label and ribbon combination. The printed images should not be too light nor should the ink from the ribbon “bleed.” The edges of each image should be crisp and well defined.

**Print Darkness** — The Print Darkness can be set from the USER Mode menu or by sending the Print Darkness software command from the host computer. There are three settings, from 1 (lightest) to 5 (darkest). The default setting is 3.

Once the range has been selected, the Darkness Setting of the Adjustment screen can be used to make finer adjustments. For instructions on setting Print Darkness, refer to **Section 3.6 User Mode**.



**Darkness** — The fine adjustment for Print Darkness is the Darkness adjustment on Adjustment screen. It provides a continuous range of adjustment, allowing you to make precise changes. See **Section 3.4 Adjustment Screen** for instructions on performing Darkness adjustments.

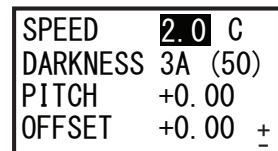

**Note:**

The DARKNESS adjustment will affect the darkness in all of the command code speed ranges, i.e., if the DARKNESS is adjusted for lighter print, the darkness will be lighter in all speed ranges selected by the command code.

#### 4.4.2 Adjusting Print Speed

Besides varying the rate at which labels are printed, this adjustment can be used to regulate any changes in print quality.

**Print Speed**— Print Speed can be set from the USER Mode menu or by sending the Print Speed software command from the host computer. There are 4 settings, from 1 ips (slowest) to 4 ips (faster). The default setting is 2 ips. For instructions on setting Print Speed, refer to **Section 3.6 User Mode**.

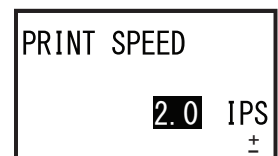

# 5

## **TROUBLESHOOTING**

---







If you are unable to produce printouts on the HR2 series printer, use this section to make sure the basics have been checked, before deciding you are unable to proceed any further.

The section is divided into four parts:





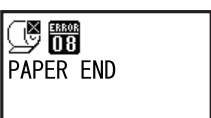

- 5.1 Error signal Troubleshooting
- 5.2 Troubleshooting Table
- 5.3 Interface Troubleshooting
- 5.4 Test Print Troubleshooting

## 5.1 ERROR SIGNAL TROUBLESHOOTING





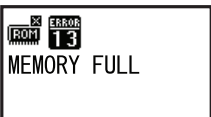

### 5.1.1 Error Message

No.	ERROR DISPLAY	LED	BUZZER	ERROR CONDITION	CORRECTIVE ACTION
01	<b>MACHINE ERROR</b> 	<b>STATUS:</b> Off <b>ERROR:</b> On	1 Long Beep	1) Defective PCB board  To clear error: Power Off	1) Consult your SATO reseller or technical support center to replace the PCB board
02	<b>FLASHROM ERROR</b> 	<b>STATUS:</b> Off <b>ERROR:</b> On	1 Long Beep	1) Access failure to Flash ROM 2) Exceeding maximum times of writing to Flash ROM.  To clear error: Power Off	1) Consult your SATO reseller or technical support center to replace the PCB board
03	<b>PARITY ERROR</b> 	<b>STATUS:</b> Blinks <b>ERROR:</b> On	3 short Beeps	1) Improper communication settings 2) Improper cable connection  To clear error: Power Off	1) Correct the Parity Settings 2) Check the cable connection
04	<b>OVERRUN ERROR</b> 	<b>STATUS:</b> Blinks <b>ERROR:</b> On	3 short Beeps	1) Improper communication settings 2) Improper cable connection  To clear error: Power Off	1) Check and correct the flow control settings and retry 2) Check the cable connection
05	<b>FRAMING ERROR</b> 	<b>STATUS:</b> Blinks <b>ERROR:</b> On	3 short Beeps	1) Improper communication settings 2) Improper cable connection  To clear error: Power Off	1) Check and correct the data bit setting and retry 2) Check the cable connection
06	<b>BUFFER OVER</b> 	<b>STATUS:</b> Blinks <b>ERROR:</b> On	3 short Beeps	1) Receiving oversized data for buffer capacity 2) Wrong protocol selected  To clear error: Power Off	1) Change the host program not to send data exceeding buffer capacity 2) Adjust the host program to correct communication protocol
07	<b>COVER OPEN</b> 	<b>STATUS:</b> Off <b>ERROR:</b> Blinks	3 short Beeps	1) Top cover is not closed. 2) Open/close micro-switch of head defect.  To clear error: Close top cover	1) Close top cover securely. 2) Adjust the micro-switch.
08	<b>PAPER END</b> 	<b>STATUS:</b> Off <b>ERROR:</b> Blinks	3 short Beeps	1) Out of Paper (media) 2) Media is not properly set  To clear error: Head open and then close	1) Replenish media supply 2) Route media through sensor correctly

## 5.1 ERROR SIGNAL TROUBLESHOOTING (Cont'd)

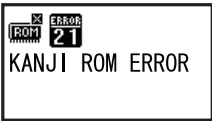
No.	ERROR DISPLAY	LED	BUZZER	ERROR CONDITION	CORRECTIVE ACTION
09	<b>RIBBON END</b> 	<b>STATUS:</b> Off <b>ERROR:</b> Blinks	3 short Beeps	1) No ribbon 2) Ribbon torn To clear error: Head open and then close	1) Check ribbon loading and/or load a new ribbon roll 2) Clean or adjust the ribbon route
10	<b>SENSOR ERROR</b> 	<b>STATUS:</b> Off <b>ERROR:</b> On	3 short Beeps	1) Improper pitch sensor level 2) Media meandering To clear error: Head open and then close	1) Adjust pitch sensor level 2) Clean and adjust the media route
11	<b>HEAD ERROR</b> 	<b>STATUS:</b> Off <b>ERROR:</b> On	1 long Beep	1) Print head damage • Error will be detected only when head check is enabled To clear error: Hold down FEED button or the combination of LINE + FEED more than 5 sec. to disable head check	1) Replace Print head or consult your SATO reseller or technical support center
12	<b>MEMORY R/W ERROR</b> 	<b>STATUS:</b> Off <b>ERROR:</b> Blinks	1 long Beep	1) Memory writing error To clear error: Power Off	1) Confirm if Flash ROM memory is installed 2) Replace the memory board. 3) Check download data.
13	<b>MEMORY FULL</b> 	<b>STATUS:</b> Off <b>ERROR:</b> Blinks	1 long Beep	1) Memory over capacity To clear error: Power Off	1) Delete unnecessary data
14	<b>DOWNLOAD DATA ERROR</b> 	<b>STATUS:</b> Off <b>ERROR:</b> On	1 long Beep	1) Reception of unauthorized download data 2) No download area To clear error: Press FEED button	1) Check download data 2) Check download data size
15	<b>BCC CHECK ERROR</b> 	<b>STATUS:</b> Off <b>ERROR:</b> Blinks	3 short Beeps	1) BCC that is added to send data (for 1 item) differs. To clear error: Press LINE button or cancel job.	1) Check host data and communication settings

## 5.1 ERROR SIGNAL TROUBLESHOOTING (Cont'd)

No.	ERROR DISPLAY	LED	BUZZER	ERROR CONDITION	CORRECTIVE ACTION
16	<b>ITEM NO ERROR</b> 	<b>STATUS:</b> Off <b>ERROR:</b> Blinks	3 short Beeps	1) Sequence number of print data (for 1 item) is not incrementing by one. <ul style="list-style-type: none"> <li>• Sequence number is not consecutive.</li> </ul> To clear error: Press LINE button or cancel job.	1) Check host data and communication settings.
17	<b>MEDIA ERROR</b> 	<b>STATUS:</b> Off <b>ERROR:</b> Blinks	3 short Beeps	1) Rewinder is full.  To clear error: Head open and then close or press FEED button.	1) Remove paper from rewinder.
18	<b>KANJI ROM ERROR</b> 	<b>STATUS:</b> Off <b>ERROR:</b> Blinks	3 short Beeps	1) Reading improper Kanji data through Kanji ROM.  To clear error: Head open and then close	1) Download Kanji data. 2) Board replacement.
19	<b>COMMAND ERROR</b>  <p>Caaa:&lt;bb&gt;:cc</p> <ul style="list-style-type: none"> <li>• Command information of detected error will be shown at the bottom of LCD.</li> </ul>	<b>STATUS:</b> Off <b>ERROR:</b> Blinks	3 short Beeps	1) Detecting improper command or parameter while printing. <ul style="list-style-type: none"> <li>• This screen appears only when command error display is enabled in Advanced Mode.</li> </ul> To clear error: Press LINE button.	1) Check print data.
20	<b>SD CARD ACCESS ERROR</b> 	<b>STATUS:</b> Off <b>ERROR:</b> Blinks	1 long Beep	1) SD card is not set in the printer 2) SD card is not set in the printer correctly 3) SD card is removed from the printer while accessing to SD card 4) SD card read / write failure 5) Unformatted SD card is used 6) Write protect SD card is used	1) Set SD card in the printer 2) Insert and remove SD card from the printer 3) Insert SD card 4) Replace SD card 5) Format SD card via CARTRIDGE mode 6) Remove write protect of SD card
21	<b>SD CARD FULL</b> 	<b>STATUS:</b> Off <b>ERROR:</b> Blinks	1 long Beep	1) SD card is full.  To clear error: Power off	1) Reserve free space in SD card.



## 5.1 ERROR SIGNAL TROUBLESHOOTING (Cont'd)

No.	ERROR DISPLAY	LED	BUZZER	ERROR CONDITION	CORRECTIVE ACTION
22	<b>HEAD LIFT ERROR</b> 	<b>STATUS:</b> Off <b>ERROR:</b> On	1 long Beep	1) Head lift sensor malfunctions. 2) Thermal head installation error. To clear error: Power Off	1) Replace head lift sensor. 2) Check thermal head installation status.

## 5.1 ERROR SIGNAL TROUBLESHOOTING (Cont'd)

### 5.1.2 More information about Command Error

#### Printer Motion when detecting Command Error

When COMMAND ERROR DISPLAY is set to YES in Advanced Mode, the information of a command in which a command error was detected will be shown at the bottom of the screen, and the print operation will be paused. This error can be cleared by pressing the **LINE** button, but the data in which an error was detected will be dumped and print operation will not be performed.

#### Position of Error Occurrence

The location of command error is shown in "Caaa" where an error is being displayed.

The number of ESC commands from ESC+A will be shown in "aaa". Note that ESC+A is not included in the number of ESC commands, which can be displayed up to 999. If the number of ESC commands exceeds 999, it will be shown as "999".



Command information in which a command error was detected

#### Example)

When a command error is detected by Horizontal Print Position <H>.

```

-----: [ESC]A
C001:   [ESC]V100
C002:   [ESC]H99999      -> Location of command error
C003:   [ESC]L0202
C004:   [ESC]X2,ABCDEF
C005:   [ESC]Q1
C006:   [ESC]Z
    
```

In this case, **C002** is the location of error.

#### Error Command Name

Command name, in which an error was detected, will be shown in "<bb>" where an error is being displayed.

\* When it is 1 byte command, it will be left aligned.

#### Error Code

Cause of command error will be indicated in code in "cc" where an error being displayed.

Code <cc>	Cause
01	Analyzed improper command
02	Received improper parameter
03	Analyzed improper graphic and external character data
04	Specified card slot is inappropriate
05	Number specified by registration command is already taken
06	Outside the registration area
07	Data is not registered
08	Specified print start position is outside the printable area
09	Printing image is outside the printable area (Barcode only)

## 5.1 ERROR SIGNAL TROUBLESHOOTING (Cont'd)

### 5.1.3 Warning Message

Note that the printer will continue issuing label while detecting a warning message.

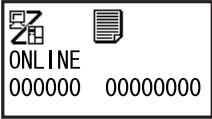
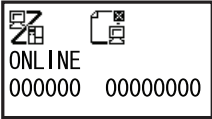
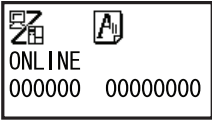
No.	WARNING DISPLAY	LED	BUZZER	ERROR CONDITION	CORRECTIVE ACTION
01	<b>BUFFER NEAR FULL</b> 	<b>STATUS:</b> On <b>ERROR:</b> Off	-	1) Free space for receive buffer is low. To clear error: Cancel print operation or Data to create more than 1.95MB free space in receive buffer	1) Cancel print operation or data to create more than 1.95MB free space in receive buffer to clear an error.
02	<b>COMMAND ERROR</b> 	<b>STATUS:</b> On <b>ERROR:</b> Off	1 short Beep	1) Detecting improper command in print data. 2) Print data is outside the printable area. • This screen appears only when command error display is disabled in Advanced Mode. To clear error: Normal data reception	1) Check data 2) Adjust print data and base reference point offset not to exceed the printable area.
03	<b>HEAD ERROR</b> 	<b>STATUS:</b> On <b>ERROR:</b> Off	-	1) This message will be displayed after detecting and clearing an electrical disconnection error of print head temporarily with the FEED button. To clear error: Power Off (Print head replacement)	1) Print head replacement

**5.2 TROUBLESHOOTING TABLE**

<b>TROUBLESHOOTING TABLE</b>	
<b>IMAGE VOIDS</b>	
Dirty print head.	Clean print head.
Defective print head.	Replace print head.
Defective main circuit board.	Have SATO authorised servicing personnel replace main board.
Damaged or worn platen roller.	Replace platen roller.
Poor label quality.	Use higher quality media. Use only SATO-certified media.
Ribbon stock and media are mismatched.	Consult with media supplier. Use only SATO-certified media.
<b>RIBBON WRINKLING</b>	
Poor head alignment.	Adjust head balance and alignment.
Poor ribbon tension.	Adjust tension as required.
Damaged or worn platen roller.	Replace platen roller.
Foreign material on print head and/or rollers.	Clean as required.
Foreign material on labels.	Use higher quality media. Use only SATO-certified media.
Defective print head.	Replace print head as required.
<b>LIGHT PRINT IMAGES</b>	
Low print head darkness.	Adjust darkness level setting.
Low print head pressure.	Adjust head pressure and/or balance.
Foreign material on print head.	Clean print head and platen roller.
Improper head alignment.	Align print head as required.
Excessive print speed.	Reduce print speed setting.
<b>UNEVEN PRINT DARKNESS</b>	
Unbalanced print head.	Adjust head balance.
Damaged or worn platen roller.	Replace platen rollers as required.
Dirty print head.	Clean print head as necessary.
<b>MEANDERING MEDIA</b>	
Incorrectly loaded media.	Ensure correct loading.
Improperly adjusted media guides.	Adjust as required.
Unbalanced print head.	Adjust as required.
Damaged or worn platen roller.	Replace platen roller as required.
<b>SMEARED PRINT IMAGES</b>	
Poor media quality	Use higher quality media. Use only SATO-certified media.
Foreign material on print head and platen roller	Clean print head and platen roller.
Foreign material on labels	Use higher quality media. Use only SATO-certified media.
Excessive print head energy	Adjust darkness level setting.
Excessive print speed	Adjust print speed as required.
Excessive print head pressure.	Adjust head balance.

**5.2 TROUBLESHOOTING TABLE (Cont'd)**

<b>TROUBLESHOOTING TABLE</b>	
<b>NO LABEL MOVEMENT</b>	
Loose or broken timing belt.	Replace or adjust as required.
Incorrect label sensor selected.	Check printer configuration for proper sensor selection.
No voltage output.	Replace fuse. Test power supply and replace as required.
Drive motor not operating.	Ensure wiring harness connection. Replace as necessary.
<b>INCORRECT LABEL POSITIONING</b>	
Incorrect label sensor selection.	Ensure the correct sensor is selected.
Improper sensor adjustment.	Adjust sensor sensitivity as required.
Data input error.	Ensure correct data stream.
Incorrect offset settings.	Adjust offset settings as required.
<b>PRINTER CREATES A BLANK LABEL</b>	
Data input error.	Ensure correct data stream.
Incorrect label sensor selection.	Set the sensor correctly.
Print head is disconnected.	Power off the printer and ensure a proper connection.
Defective print head.	Replace print head as required.
Defective main circuit board.	Have SATO authorised servicing personnel replace main board.
<b>LCD FIELD ILLUMINATED BUT WITHOUT WORDS OR NO DISPLAY AT ALL</b>	
Power supply issues.	Ensure cable properly connected. Check/replace power supply.
Screen contrast is incorrectly adjusted.	Adjust as required.

### 5.3 INTERFACE TROUBLESHOOTING

This chapter provides a checklist for the various interface types. Locate the checklist relative to the interface used and perform each of the troubleshooting tasks until the problem has been isolated.

<b>RS232 SERIAL INTERFACE</b>	
<b>CHK</b>	<b>TROUBLESHOOTING STEP</b>
	Ensure the correct interface module is correctly installed. Run self-test to verify.
	Ensure the serial cable (Null Modem) meets specifications and is correctly connected at each end.
	Ensure the serial cable is not defective.
	Ensure the communication parameters for the baud rate, parity, data bits and stop bits are consistent with those being sent from the host computer.
	Ensure the printer is receiving information from the computer using the Receive Buffer Hex Dump mode. Refer to that procedure within this manual for instructions. The command stream should be continuous and possess 0Dhex and/or 0Ahex (carriage return and line feed) characters throughout. However, there should not be either located between the start (<ESC>A) and the stop (<ESC>Z) commands.
	Try another port to isolate the problem.
	Replace the main circuit board if determined to be the problem.

<b>UNIVERSAL SERIAL BUS (USB) INTERFACE</b>	
If nothing prints during a test print, verify the device drivers have been successively installed by performing the following:	
<b>CHK</b>	<b>TROUBLESHOOTING STEP</b>
	Click on Start, Settings, and then Control Panel.
	Click on System within the new window.
	Click on the Device Manager tab.
	Ensure that the View Device By Type is checked.
	Scroll to SATO-USB Device and ensure that errors do not exist. Reinstall as required.
	Reboot the PC and the printer.

<b>LAN ETHERNET INTERFACE</b>	
<b>CHK</b>	<b>TROUBLESHOOTING STEP</b>
	Ensure the interface has been correctly configured. Wait two minutes and run self-test to verify. If a test label does not print, there may be a hardware problem.
	Ensure the cable and its ports are not defective.
	Ensure that a faulty print server or other protocol related scenarios are not creating a queue setup issue. Systematically perform checks and tests to isolate the cause.
	If using TCP/IP, ensure that a valid IP address is specified and that all parameters are correct (subnet mask, gateway, etc.). Attempt to PING the IP address assigned to the network interface.
	If using a repeater or hub, ensure the SQE is turned off. Also ensure the repeater port is not defective by trying the print server on another port.
	Install the IPX/SPX protocol on a workstation to determine if the network device can be discovered via the MAC address. If able, configure the appropriate protocols and retest connectivity.
	Use a crossover cable to isolate the printer from the network by connecting from the interface and workstation. Verify that the parameters match on each. Test connectivity.

## 5.4 TEST PRINT TROUBLESHOOTING

---

Chapter provides instruction on special printing to identify and resolve specific print problems.

### 5.4.1 Hex Dump

Allows the operator to determine if there were problems in the downloading of data. The contents of the print buffer can be examined using the Hex Dump Mode. In the left column, each line of data received is numbered. The center column provides the data in hexadecimal format. And in the right column, the same data is provided in the ASCII format. Refer to **Section 3.11 HEX Dump Mode** for more details to perform this activity.

### 5.4.2 Test label printing

Allows the operator to identify specific problems regarding mechanical performance and setup. The test label is designed to assist in the identification of print problems. Refer to **Section 3.12 Received Data Saving Mode** for more details to perform this activity.

**This page is intentionally left blank**



# 6

## BASIC SPECIFICATIONS

### 6.1 PRINTER BASIC SPECIFICATIONS

<b>MODEL NAME</b>	HR212 / HR224
-------------------	---------------

<b>PHYSICAL CHARACTERISTICS</b>	
Width	197 mm (7.75")
Height	285 mm (11.22")
Depth	365 mm (14.37")
Weight	16.4Kg (36.16 lbs.)

<b>POWER SUPPLY</b>		
Input Voltage	Input power voltage: AC 100V - 240V, +/-10% (Full range) Rated input voltage: AC 100V - 240V (Full range)	
Power Consumption	HR212:	At peak: 95W / 95VA (Print ratio 30%) In standby: 26W / 27VA
	HR224:	At peak: 115W / 115VA (Print ratio 30%) In standby: 26W / 27VA

<b>ENVIRONMENTAL (EXCLUDING MEDIA)</b>	
Operating Temperature	0° to 40°C (32 to 104 F)
Storage Temperature	-5° to 60°C (23 to 140 F)
Operating Humidity	10 to 80% RH, Non-condensing
Storage Humidity	10 to 90% RH, Non-condensing

<b>PRINT</b>	
Method	Thermal Transfer
Print Speed (selectable)	25 to 100 mm/sec (1 to 4"/sec) (Setting value: 0.5"/sec increments) *Print speed varies depending on the media used.
Resolution	HR212: 12 dots/mm (305 Dots Per Inch) HR224: 24 dots/mm (609 Dots Per Inch)
Maximum Print Width	56 mm (2.2")
Maximum Print Length	200 mm (7.9")
Print darkness	Darkness range: A to B Darkness level: 1 to 5

Section 6: Basic Specifications

PRINT		
Precision of print position	Dispenser mode	Print start position: [GAP sensor] Within $\pm 0.3$ mm (0.012") [I-Mark sensor] Within $\pm 1.5$ mm (0.059") Width direction: Within $\pm 0.3$ mm (0.012")
	Continuous mode	Print start position: [GAP sensor] Within $\pm 0.3$ mm (0.012") [I-Mark sensor] Within $\pm 1.0$ mm (0.039") Width direction: Within $\pm 0.3$ mm (0.012")
	Tear-off mode	Print start position: [GAP sensor] Within $\pm 0.5$ mm (0.019") [I-Mark sensor] Within $\pm 1.5$ mm (0.059") Width direction: Within $\pm 0.3$ mm (0.012")
	Operating environment: Temperature 0 to 40°C (32 to 104 F)/Humidity 10 to 80%RH (Non-condensing)  *Using the Gap sensor will provide better print start position accuracy as compared to using the I-Mark sensor. The difference in label processing accuracy, label pitch and label detection motion may influence the accuracy of print start position. *The print accuracy above is tested based on specific conditions and is not guaranteed. Depending on label, ribbon and label size conditions, it may not be possible to obtain the value above. Also, it excludes the label tolerance. Using SATO precise measurement labels with $\pm 0.2$ mm tolerance is recommended.	
Precision of print expansion	Within the range of $\pm 1\%$ toward paper feed direction	
Unprintable area	Pitch direction	Top: 0.5 mm (0.019"), Bottom: 0.5 mm (0.019") (Not including liner)
	Width direction	Left: 0.5 mm (0.019"), Right: 0.5 mm (0.019") (Not including liner)

MEDIA (Be sure to use media manufactured or certified by SATO)		
Size	Label	Continuous Width: 7 to 58 mm (0.3" to 2.3") Width including liner: 10 to 61 mm (0.4" to 2.4") Pitch: 3 to 197 mm (0.1" to 7.7") Pitch including liner: 6 to 200 mm (0.2" to 7.8")
		Tear-off Width: 7 to 58 mm (0.3" to 2.3") Width including liner: 10 to 61 mm (0.4" to 2.4") Pitch: 3 to 197 mm (0.1" to 7.7") Pitch including liner: 6 to 200 mm (0.2" to 7.8")
		Dispenser Width: 7 to 58 mm (0.3" to 2.3") Width including liner: 10 to 61 mm (0.4" to 2.4") Pitch: 3 to 197 mm (0.1" to 7.7") Pitch including liner: 6 to 200 mm (0.2" to 7.8")
** The above sizes are structurally possible; however, some restrictions may apply depending on paper types, use environment and usage. Make sure to check the paper size and corresponding print mode before operations.		
Type	Thermal Transfer Use roll media specified by SATO.	
Roll Diameter	Maximum outer diameter: 185 mm (7.3")	
Core Diameter	Inner core diameter: 76.4 mm (3.0")	
Thickness	Label: 0.13 to 0.220 mm (0.005" to 0.008")	

<b>MEDIA (Be sure to use media manufactured or certified by SATO)</b>	
Wind Direction	Face-Out
Paper setting position	Drop-in position, Center position after loading the label roll on the holder

<b>RIBBON (Be sure to use ribbon manufactured or certified by SATO)</b>	
Width	Max. 65 mm (2.55")
Length	Max. 150 m (492.1ft.)
Wind Direction	Face-In
Winding Method	Wind on roll (Roll inner diameter: $\phi$ 1", supporting paper roll only)
Max Roll outer diameter	51 mm (2.0")

<b>PROCESSING</b>	
CPU	32 Bit RISC-CPU
Flash ROM	32 Megabytes
SDRAM	16 Megabytes
Communication buffer	Max. 2.95 MB (Near full 2 MB)
External memory	SD card (1 GB / Max 2 GB recommended)

<b>PRINTER LANGUAGE</b>	
Standard	SATO Barcode Printer Language (SBPL)

<b>INTERFACES</b>	
Interface	(1) USB 2.0 (2) LAN (10BASE-T/100BASE-TX Auto detection) (3) RS-232C (DSUB9 pin-female) *For data transmission or connection to the SATO Keypad (4) EXT Port (Amphenol 14 pin-female) (5) SD card slot (1 slot)

<b>SENSING</b>	
Gap (Transmissive)	Sensitivity Adjustable
I-Mark (Reflective)	Sensitivity Adjustable
Cover Open	Fixed
Dispense	Position Adjustable
Ribbon End	Fixed
Rewinder Full	Fixed
Head Lift	Fixed

<b>SELF-DIAGNOSIS FUNCTION</b>	
	(1) Thermal head burnout check (2) Paper end detection (3) Ribbon end detection (4) Cover open detection (5) Test print (6) Re-winder full detection (7) Head Lift detection

<b>CHARACTER FONT CAPABILITIES</b>	
<b>MATRIX FONTS</b>	
X20	5× 9dot (Alphanumeric, Symbols)
X21	17×17dot (Alphanumeric, Symbols)
X22	24×24dot (Alphanumeric, Symbols)
X23	48×48dot (Alphanumeric, Symbols)
X24	48×48dot (Alphanumeric, Symbols)
U font	5× 9dot (Alphanumeric, Symbols)
S font	8×15dot (Alphanumeric, Symbols)
M font	13×20dot (Alphanumeric, Symbols)
WB font	18×30dot (Alphanumeric, Symbols)
WL font	28×52dot (Alphanumeric, Symbols)
OCR-A (HR212)	22×33dot (Alphanumeric, Symbols)
OCR-B (HR212)	30×36dot (Alphanumeric, Symbols)
OCR-A (HR224)	44×66dot (Alphanumeric, Symbols)
OCR-B (HR224)	60×72dot (Alphanumeric, Symbols)
<b>RASTERIZED FONTS</b>	
	CG Times (Alphanumeric, Symbols) CG Triumvirate (Alphanumeric, Symbols)

<b>CHARACTER FONT CAPABILITIES</b>	
<b>OUTLINE FONTS</b>	
	Alphanumeric, Symbols
<b>CHARACTER CONTROL</b>	
Magnification	Expansion up to 12 x in either the vertical or horizontal
Rotation	0°, 90°, 180°, 270°

<b>BARCODE CAPABILITIES</b>	
Linear Bar Codes	UPC-A, UPC-E, JAN 13, JAN 8, EAN-13, EAN-8, CODE39, CODE93, CODE128 (128A,128B,128C), GS1-128 (UCC/EAN128) (Character set: Set-A, Set-B, Set-C), CODABAR (NW-7), ITF, Industrial 2of5, Matrix 2of5, Customer barcode, UPC add-on barcode, GS1 Databar (RSS) GS1 DataBar Omni-directional,GS1 DataBar Truncated,GS1 DataBar Stacked, GS1 DataBar Stacked Omni-Directional,GS1 DataBar Limited, GS1 DataBar Expanded,GS1 DataBar Expanded Stacked
Two Dimensional	QR code, MicroQR, PDF417, MicroPDF MAXI code, DataMatrix (ECC200), Security QR code

BARCODE CAPABILITIES	
Composite Symbols	EAN-13 Composite (CC-A/CC-B) EAN-8 Composite (CC-A/CC-B) UPC-A Composite (CC-A/CC-B) UPC-E Composite (CC-A/CC-B) GS1 DataBar Composite (CC-A/CC-B) GS1 DataBar Truncated Composite (CC-A/CC-B) GS1 DataBar Stacked Composite (CC-A/CC-B) GS1 DataBar Stacked Omni-Directional Composite (CC-A/CC-B) GS1 DataBar Limited Composite (CC-A/CC-B) GS1 DataBar Expanded Composite (CC-A/CC-B) GS1 DataBar Expanded Stacked Composite (CC-A/CC-B) GS1-128 Composite (CC-A/CC-B/CC-C)
Ratios	1:2, 1:3, 2:5, User definable bar widths
Rotation	Parallel 1 (0°), Parallel 2 (180°), Serial 1 (90°) and Serial 2 (270°)
Magnification	1 to 12 times

VERSATILE FUNCTIONS	
	(1) Status return function (2) Graphic function (3) Sequential number function (4) Form overlay function (5) Custom character registration function (6) Character correction function (7) Black/white inversion function (8) Ruled line function (9) Dump list function (10) Format registration function (11) Outline function (12) Outline modification function (13) Label skip function (14) Zero slash switching function (15) Circular arc function

HARDWARE AND RELATED	
Operation keys	1) Power switch 2) <b>LINE</b> button 3) <b>FEED</b> button 4) + button 5) - button 6) < button 7) > button
Indicators	STATUS: Green LED ERROR: Red LED
Buzzer	Built-in buzzer * Buzzer can be disabled by the command.

Section 6: Basic Specifications

<b>OPTIONS</b>	
	Keypad SD card

<b>DURABILITY</b>		
Mechanical durability	Print head	60 km (37.3 miles)
	Platen roller	30 km (18.6 miles)
	Belt	50 km (31.1 miles)
	Motor	50,000 hrs
Product life	300 km (186.4 miles)	
Operating life	5 years	

<b>REGULATORY COMPLIANCE</b>	
Safety regulation	IEC/ EN60950-1 2nd (Europe) CCC (GE4943) (China)
EMC regulation	CE (EN55022B, EN55024, En61000) (Europe) CCC (GB4943-(2001)) (-2nd)
Packaging Drop Standard	ISTA-2A
Environmental (RoHS)	The RoHS directive restricts the use of six hazardous materials listed below. Hexavalent chromium-----Max. 0.1% Lead and lead compounds-----Max. 0.1% Mercury and mercury compounds-----Max. 0.1% Cadmium and cadmium compounds -----Max. 0.01% Polybrominated biphenyls (PBB)-----Max. 0.1% Polybrominated diphenyl ethers (PBDE)----Max. 0.1%

# 7

## INTERFACE SPECIFICATIONS

---

This section presents the interface types and their specifications for the HR2 series printers. These specifications include detailed information to assist in the selection of the most appropriate method for the printer to interface with the host.

The following information is presented in this section:

- 7.1 Interface Types
- 7.2 RS232C High Speed Serial Interface
- 7.3 Universal Serial Bus (USB) Interface
- 7.4 Local Area Network (LAN) Ethernet
- 7.5 External Signal Interface (EXT)

### 7.1 INTERFACE TYPES

---

HR2 series printers are equipped with multiple interfaces to perform data communication with the host, an external signal interface to connect peripheral devices to the printer, and an interface to connect a keypad to the printer.

The following built-in interfaces are available.



- 1) RS-232C interface (can be used for Keypad)
- 2) USB interface
- 3) LAN interface
- 4) External signal interface (Amphenol 14 pin-female)

**Caution**

- Never connect or disconnect interface cables (or use a switch box) with power applied to either the host or printer. This may cause damage to the interface circuitry in the printer/ host and is not covered by warranty.

## 7.2 RS232C HIGH SPEED SERIAL INTERFACE

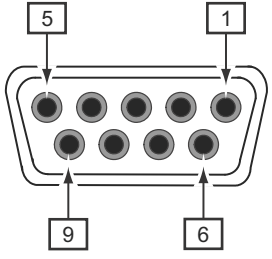
### 7.2.1 Basic Specifications

Interface connector												
Synchro system	Asynchronous method											
Maximum receive buffer capacity	<p>2.95MB</p> <p style="text-align: center;">0MB <span style="float: right;">2.95MB</span></p> <p>Buffer near full occurred  Remaining 0.95MB</p> <p>Buffer near full released  Remaining 1.95MB</p>											
Code	ASCII (7 bits), Graphic (8 bits)											
Connectors	Printer side Cable side Cable length	DSUB9 pin (female) DSUB9 pin (male) less than 5m										
Transmission form	<table border="1" style="width: 100%; text-align: center;"> <tr> <td>Start</td> <td>b1</td> <td>b2</td> <td>b3</td> <td>b4</td> <td>b5</td> <td>b6</td> <td>b7</td> <td>b8</td> <td>Stop</td> </tr> </table> <p>[Note] If using 7 bits, b8 will be omitted.</p>		Start	b1	b2	b3	b4	b5	b6	b7	b8	Stop
Start	b1	b2	b3	b4	b5	b6	b7	b8	Stop			
Signal level	<p>High level : +5 to +12V</p> <p>Low level : -5 to -12V</p>											



## 7.2 RS232C HIGH SPEED SERIAL INTERFACE (Cont'd)

### 7.2.2 Ready/Busy

Ready / Busy is the hardware flow control method for the serial interface on the printer. Single item buffer and multi buffer can be toggled in the Interface Mode of the printer.

When the print data (STX ESC+"A"~ ESC+"Z" ETX) is sent from the host in the conditions below, received data may be incorrect.

- 1) When the printer is in Offline state
- 2) When an error has occurred in the printer

### Pin Assignments

Printer		Host computer	
CD	1	—————	1 CD
RD	2	←————	3 SD
SD	3	————→	2 RD
ER	4	————→	6 ER
SG	5	—————	5 SG
DR	6	←————	4 DR
RS	7	————→	8 CS
CS	8	←————	7 RS
RI	9	←————	9 RI

### Interface Signals

Pin no.	Signal Type	Direction	Description
2	RD	Input	Data transferred from the host to the printer.
3	SD	Output	Data transferred from the printer to the host.
4	ER	Output	Data device ready. It goes "High" when the printer is ready to receive data. It goes "Low" when an error has occurred in the printer or when the printer is in offline state.
5	SG	-	Signal ground
6	DR	Input	Data set ready.
7	RS	Output	Transmission request.
8	CS	Input	Transmission available
9	RI	Input	Call

**7.2 RS232C HIGH SPEED SERIAL INTERFACE (Cont'd)**

---

**7.2.3 X-ON/X-OFF**

This transmission protocol informs the host if the printer can receive data or not, by sending the "XON" (Hex 11H) or "XOFF" (Hex 13H) code to SD line.

Single-item buffer and multiple buffers are switchable in the interface mode of the printer.

When the print data (STX ESC+"A"~ ESC+"Z" ETX) is sent from the host in the conditions below, received data may be incorrect.

- 1) When the printer is in Offline state
- 2) When an error has occurred in the printer

**Pin Assignments**

1)DB-9P

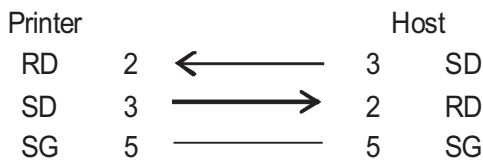

**Note:**

Depending on the host used, it may need to loop CS and RS (maintaining at "High" level) on the host side. Therefore, make sure to re-check the host before use.



**Input/Output Signals**

Pin no.	Signal Type	Direction	Description
2	RD	Input	Data transferred from the host to the printer
3	SD	Output	Data transferred from the printer to the host
5	SG	-	Signal ground

### 7.3 UNIVERSAL SERIAL BUS (USB) INTERFACE

The Universal Serial Bus (USB) interface of the print complies with USB2.0 standard.

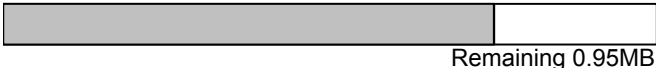
#### 7.3.1 Basic Specifications

Interface connector	<div style="text-align: center;">  </div> <p>Series B plug Cable length: 5m or less (Twisted Pair Shielded)</p>
Version	USB 2.0
Maximum receive buffer capacity	<p>2.95MB</p> <div style="display: flex; align-items: center;"> <div style="margin-right: 20px;"> <p>0MB</p> <p>Buffer near full occurred</p> </div> <div style="margin-right: 20px;">  </div> <div style="margin-left: 20px;"> <p>2.95MB</p> </div> </div> <div style="display: flex; align-items: center; margin-top: 10px;"> <div style="margin-right: 20px;"> <p>Buffer near full released</p> </div> <div style="margin-right: 20px;">  </div> <div style="margin-left: 20px;"> <p>Remaining 1.95MB</p> </div> </div>

#### 7.3.2 Pin Assignments

Pin No.	Description
1	VBus
2	-Data(D-)
3	+Data(D+)
4	GND

## 7.4 LOCAL AREA NETWORK (LAN) ETHERNET

### 7.4.1 Basic Specifications

Interface connector	<div style="text-align: center;">  </div> <p>Cable type: For 10BASE-T and 100BASE-TX Cable length: 100m or less</p>									
Link/Status LED	<p>Status LED lights up when establishing the LINK with Ethernet device or when receiving the packets.</p> <table border="1" data-bbox="520 891 1380 1093"> <thead> <tr> <th>LED</th> <th>Color</th> <th>Description</th> </tr> </thead> <tbody> <tr> <td>LINK</td> <td>Green</td> <td>Lights up when establishing LINK</td> </tr> <tr> <td>SPEED</td> <td>Yellow</td> <td>Lights off when recognizing the connection to 10BASE-T. Lights up when recognizing 100BASE-TX.</td> </tr> </tbody> </table>	LED	Color	Description	LINK	Green	Lights up when establishing LINK	SPEED	Yellow	Lights off when recognizing the connection to 10BASE-T. Lights up when recognizing 100BASE-TX.
LED	Color	Description								
LINK	Green	Lights up when establishing LINK								
SPEED	Yellow	Lights off when recognizing the connection to 10BASE-T. Lights up when recognizing 100BASE-TX.								

**7.4.1 Basic Specifications (Cont'd)**

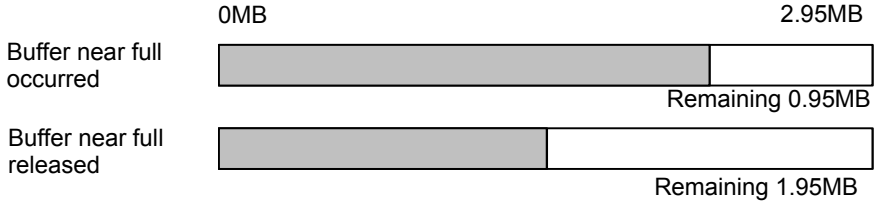
<p>Communication setup</p>	<p>The following communication settings are available in the Interface Mode of the printer.</p> <table border="1" data-bbox="518 358 1380 896"> <thead> <tr> <th>Item</th> <th>Setting range</th> </tr> </thead> <tbody> <tr> <td>Protocol</td> <td>STATUS3 STATUS4 (Cyclic response mode) STATUS4 (ENQ response mode) STATUS5</td> </tr> <tr> <td>IP address</td> <td>0.0.0.0 ~ 255.255.255.255</td> </tr> <tr> <td>Subnet mask</td> <td>0.0.0.0 ~ 255.255.255.255</td> </tr> <tr> <td>Gateway address</td> <td>0.0.0.0 ~ 255.255.255.255</td> </tr> <tr> <td>IP address setting</td> <td>DHCP Disable (Set by manual) DHCP Enable Default: Disable (Set by manual)</td> </tr> <tr> <td>RARP setting</td> <td>RARP Disable RARP Enable Default: Disable</td> </tr> </tbody> </table> <p>* IP address, Subnet mask, Gateway address can be set by printer setting tool in the accessory CD.</p>	Item	Setting range	Protocol	STATUS3 STATUS4 (Cyclic response mode) STATUS4 (ENQ response mode) STATUS5	IP address	0.0.0.0 ~ 255.255.255.255	Subnet mask	0.0.0.0 ~ 255.255.255.255	Gateway address	0.0.0.0 ~ 255.255.255.255	IP address setting	DHCP Disable (Set by manual) DHCP Enable Default: Disable (Set by manual)	RARP setting	RARP Disable RARP Enable Default: Disable
Item	Setting range														
Protocol	STATUS3 STATUS4 (Cyclic response mode) STATUS4 (ENQ response mode) STATUS5														
IP address	0.0.0.0 ~ 255.255.255.255														
Subnet mask	0.0.0.0 ~ 255.255.255.255														
Gateway address	0.0.0.0 ~ 255.255.255.255														
IP address setting	DHCP Disable (Set by manual) DHCP Enable Default: Disable (Set by manual)														
RARP setting	RARP Disable RARP Enable Default: Disable														
<p>Maximum receive buffer capacity</p>	<p>2.95MB</p> 														

## 7.4 LOCAL AREA NETWORK (LAN) ETHERNET (Cont'd)

---

### 7.4.2 Software Specifications

Protocol	TCP/IP
Network layer	ARP, RARP, IP, ICMP
Session layer	TCP, UDP
Application layer	LPD, FTP, TELNET, DHCP

#### Notes

- Send the print data by LPR and FTP of TCP/IP and dedicated socket protocol.
- Use socket connection to get the printer status.

### 7.4.3 TCP/IP Specifications

In TCP/IP protocol environment, LPD and FTP are provided for printing. TELNET for the setup of variable, and RARP and DHCP for the setup of each address are available.

In socket connection, the transmission of print data and the printer status can be monitored. Note that multiple sessions cannot be established at the same time.

Windows2000/XP/Server2003/Vista operating systems support LPD of TCP/IP that enables you to print.

In Windows2000(excluding Advanced Server)/XP/Server2003(R2 is yet to be verified)/Vista environments, IP address and various items are settable by the utility [Network setting tool].

### 7.4.4 LPD Specifications

LPD protocol complies with RFC1179 and handles the list of logical printer name as queue name such as lp, sjis and euc.

Queue name	Kanji filter applied	Input Kanji code
lp	Not available	N/A
sjis	Available	Shift JIS
euc	Available	EUC

When sending a job by LPR, the transmission order of data file/control file within the job does not affect the printing operation.

#### Notes

- A job deletion by LPR is not supported.
- LPD can be used for STATUS4 only
- When large quantity printing is performed by LPD, data may be lost caused by Windows specification.
- Banner page print is not supported.

### 7.4.5 FTP Specifications

FTP protocol complies with RFC959 and handles the list of logical printer name as transfer directory. File transfer to this directory executes print operation. Note that it is possible to specify ASCII(A), BINARY(I), and TENEX(L8) as transfer modes, although mode difference is dependent on the client side.

There are three directory names such as lp, sjis and euc.

## 7.4 LOCAL AREA NETWORK (LAN) ETHERNET (Cont'd)

---

Queue name	Kanji filter applied	Input Kanji code
lp	Not available	N/A
sjis	Available	Shift JIS
euc	Available	EUC

### Note

- Banner page print is not supported.

### 7.4.6 TELNET Specifications

TELNET complies with RFC854. This consists of an interactive menu form, and it enables you to change and refer internal setup and to display status. To change the setting details, enter 'root' user name and password at the time of login. Default value of root password is set to null (line feed only).

<Example of TELNET command>

In MS-DOS command prompt, type in [TELNET xxx.xxx.xxx.xxx (IP address)] and enter user name and password to advance to the display below.

#### For Local Area Network (LAN) Ethernet

```
SATO PRINTER ModelName TELNET server.
Copyright 2010(C) SATO Corporation.
login: root
'root' user needs password to login
password:
User 'root' logged in
```

```
No. Item Value (level.1)
```

---

```
1: Setup TCP/IP
2: Display status
99: Exit setup
Please select(1-99)?
```

1. Printer name is enter in [ModelName].
2. For the detailed settings of [1:Setup TCP/IP], refer to [Section 7.4.7 Setting/Displayed Items].

**7.4 LOCAL AREA NETWORK (LAN) ETHERNET (Cont'd)**

**7.4.7 Setting/Displayed Items**

The following table shows the settings and referable sections as well as various variables.

TCP/IP related settings

Variable identifier	Setting range	Default (Factory setting)
IP address	0.0.0.0 ~ 255.255.255.255	0.0.0.0 (Externally obtained)
Subnet mask	0.0.0.0 ~ 255.255.255.255	0.0.0.0 (Derived from IP address)
Gateway address	0.0.0.0 ~ 255.255.255.255	0.0.0.0 (Invalid)
RARP protocol	ENABLE/ DISABLE	ENABLE
DHCP protocol	ENABLE/ DISABLE	ENABLE
Keep alive time	30 ~ 300	180 seconds
Socket cancel	Normal / compatible	Normal
ROOT password	Up to 16 random alphanumeric characters	NULL (No password)

**7.4.8 Socket Connection**

In socket server of TCP/IP, using Port1024 for receiving print data and Port1025 for returning printer status. In this case, port number cannot be changed.

For each socket, multiple sessions cannot be established simultaneously.

LPR and FTP can be used for sending print data other than socket connection. When LPR or FTP is used, the connection to Port1024 cannot be established.

**1. Print operation by 2-port connection/Socket(STATUS4)**

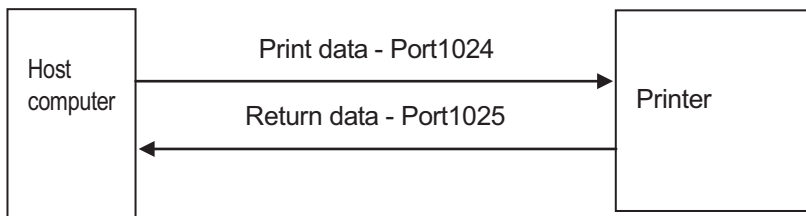

**2. Print operation by 1-port connection/Socket (STATUS3, STATUS5 return)**

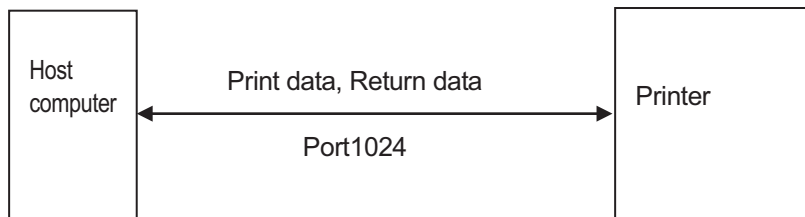



## 7.4 LOCAL AREA NETWORK (LAN) ETHERNET (Cont'd)

---

### 3. Print operation by LPR and FTP

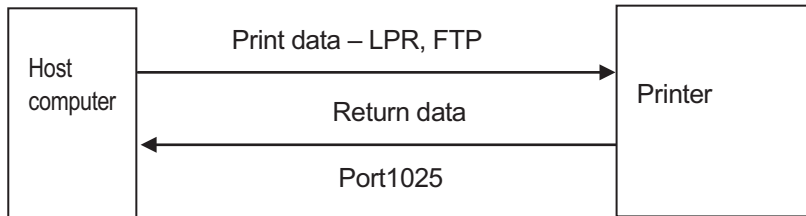

### 7.4.9 Operating Suggestions

#### Onboard LAN

1. For the onboard LAN settings, refer to the attached [Setup Guide] and the network setting tool instructions included in the accessory CD-ROM.

When opening and closing the print data port (Port1024) and the status port (Port1025), wait for 150ms and 200ms from the closing to the opening of the port to avoid a double connection.

If the [CONNECT] request is sent to the port already connected (Port1024, Port1025), that request will be rejected (Socket CLOSE).

#### Onboard LAN Interface

1. Connecting and disconnecting the LAN cable while the computer is connected may result in a communication failure.

Do not connect and disconnect the LAN cable while starting up the printer. Doing so may result in a communication failure. Please restart the printer to recover from such an error.

## 7.5 EXTERNAL SIGNAL INTERFACE (EXT)

---

External signal interface is designed to connect the printer to external peripheral devices.

External signal interface works in continuous mode or pulse input mode of cutter (print by external signal input). When error has occurred on the printer, error signal is output in any mode.

External signal setting is set in the advanced mode of the printer.

**7.5 EXTERNAL SIGNAL INTERFACE (EXT) (Cont'd)**

**7.5.1 Basic Specifications**

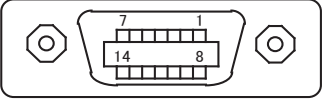
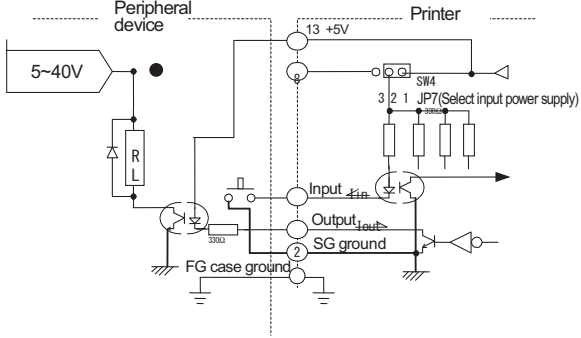
<p>Connector terminal</p>	<p>14-pin external signal interface</p> 										
<p>Input/output circuit diagram</p>	<p>14 pin type e.g.) Input/output connection</p> 										
<p>Signal level</p>	<p>High +4.2 ~ 5V:      Input terminal <math>I_{in} \cong 0\text{mA}</math>    Output terminal <math>I_{out} \cong 0\text{mA}</math>          Low 0 ~ 0.7V or less:    Input terminal <math>I_{in} \cong 10\text{mA}</math>    Output terminal <math>I_{out} \cong 10\text{mA}</math></p>										
<p>External signal</p>	<p>Select "ENABLE" or "DISABLE" in the advanced mode.</p>										
<p>External signal type</p>	<p>Signal type can be selected in the advanced mode.</p> <table border="1" data-bbox="576 1196 1326 1626"> <thead> <tr> <th>Type</th> <th>Description</th> </tr> </thead> <tbody> <tr> <td>TYPE 1</td> <td>Print end signal (PREND) remains "Low" before issuing labels. Signal level becomes "High" after print operation. 20ms later, the signal level becomes "Low" again.</td> </tr> <tr> <td>TYPE 2</td> <td>Print end signal (PREND) remains "High" before issuing labels. Signal level becomes "Low" after print operation. 20ms later, the signal level becomes "High" again.</td> </tr> <tr> <td>TYPE 3</td> <td>Print end signal remains (PREND) "Low" before issuing labels. Signal level remains "High" from the print start to the end, and then goes back to "Low" after print operation.</td> </tr> <tr> <td>TYPE 4</td> <td>Print end signal remain(PREND) remains "High" before issuing labels. Signal level remains "Low" from the print start to the end, and then goes back to "High" after print operation.</td> </tr> </tbody> </table>	Type	Description	TYPE 1	Print end signal (PREND) remains "Low" before issuing labels. Signal level becomes "High" after print operation. 20ms later, the signal level becomes "Low" again.	TYPE 2	Print end signal (PREND) remains "High" before issuing labels. Signal level becomes "Low" after print operation. 20ms later, the signal level becomes "High" again.	TYPE 3	Print end signal remains (PREND) "Low" before issuing labels. Signal level remains "High" from the print start to the end, and then goes back to "Low" after print operation.	TYPE 4	Print end signal remain(PREND) remains "High" before issuing labels. Signal level remains "Low" from the print start to the end, and then goes back to "High" after print operation.
Type	Description										
TYPE 1	Print end signal (PREND) remains "Low" before issuing labels. Signal level becomes "High" after print operation. 20ms later, the signal level becomes "Low" again.										
TYPE 2	Print end signal (PREND) remains "High" before issuing labels. Signal level becomes "Low" after print operation. 20ms later, the signal level becomes "High" again.										
TYPE 3	Print end signal remains (PREND) "Low" before issuing labels. Signal level remains "High" from the print start to the end, and then goes back to "Low" after print operation.										
TYPE 4	Print end signal remain(PREND) remains "High" before issuing labels. Signal level remains "Low" from the print start to the end, and then goes back to "High" after print operation.										
<p>Reissuing external signal</p>	<p>The following can be set in the advanced mode.          ENABLE: Print the same label again.          DISABLE: No reprint.</p>										
<p>Waiting for the end of label dispensing</p>	<p>The following can be set in the advanced mode.          ENABLE: Signal level(*) maintains "High" while waiting for the end of label dispensing.          DISABLE: Signal level does not change while waiting for the end of label dispensing.          * Changes the signal output direction by the service mode setting. For more details, refer to <b>Section 7.5.2 Pin Assignments</b>.</p>										

## 7.5 EXTERNAL SIGNAL INTERFACE (EXT) (Cont'd)

### 7.5.2 Pin Assignments

Pin No.	Signal name	Description	I/O	Level	Electric conditions (voltage, current [MAX])
1	Paper end	Outputs a signal when paper end is detected	Output	Low	5V 400mA
2	GND	SIGNAL GROUND	—	—	—
3	Ribbon end	Outputs when ribbon end is detected	Output	High	5V 400mA
4	Machine error	Outputs a signal when cover open, head error or communication error occurs	Output	Low	5V 400mA
5	Print start signal (PRIN)	The printer prints out a single label whenever this signal is input	Input	Low	High: High impedance Low: -15mA or more,0V
6	Print end signal (PREND) *1	Outputs a signal by the printing motion of a single label	Output	Low	5V 400mA
7	Reprint signal (PRIN2)	Reprints a label by inputting this signal	Input	Low	High: High impedance Low: -15mA or more,0V
8	EXT5V_IN	For external power supply	Input	—	5V *2
9	Online *3	Outputs a signal when the printer goes online *4	Output	Low	5V 400mA
10	Wait for the end of label dispensing signal	Outputs a signal while waiting for label dispensing *4	Output	Low	5V 400mA
11	—	—	—	—	—
12	+24V	—	—	—	2A
13	+5V	—	—	—	500mA
14	—	—	—	—	—

- \*1. Pin 6: Select one of four [PREND] output signals (Refer to “External signal type” in [Section 7.5.1 Basic Specifications]).
- \*2. By setting SW4 to the side of [2-3], the printer operates by supplying power from EXT5V\_IN(Pin 8).  
By setting SW4 to the side of [1-2], the printer operates by supplying power internally.
- \*3. By setting SW3 to the side of [1-2], the printer operates as “output - offline”.  
By setting SW3 to the side of [2-3], pin 9 works as an input.
- \*4. In the service mode, the signal output direction can be changed to pin 9 or 10.  
If selecting pin 9 while the external signal and the output signal for the end of label dispensing are enabled, toggling online and offline statuses will not output a signal.

#### [Important]

External signal may become unstable for approximately 1 second after turning on the printer. Wait for 1 second or more before you start controlling the signal.

**This page is intentionally left blank**

# 8

## APPENDIX

---

The following information is provided:

- 8.1 Positions of Sensors and Options
- 8.2 Operation Mode Selection
- 8.3 Base Reference Point
- 8.4 Base Reference Point Adjustment
- 8.5 Paper End
- 8.6 Ribbon End
- 8.7 Rewinder Full

### 8.1 POSITIONS OF SENSORS AND OPTIONS

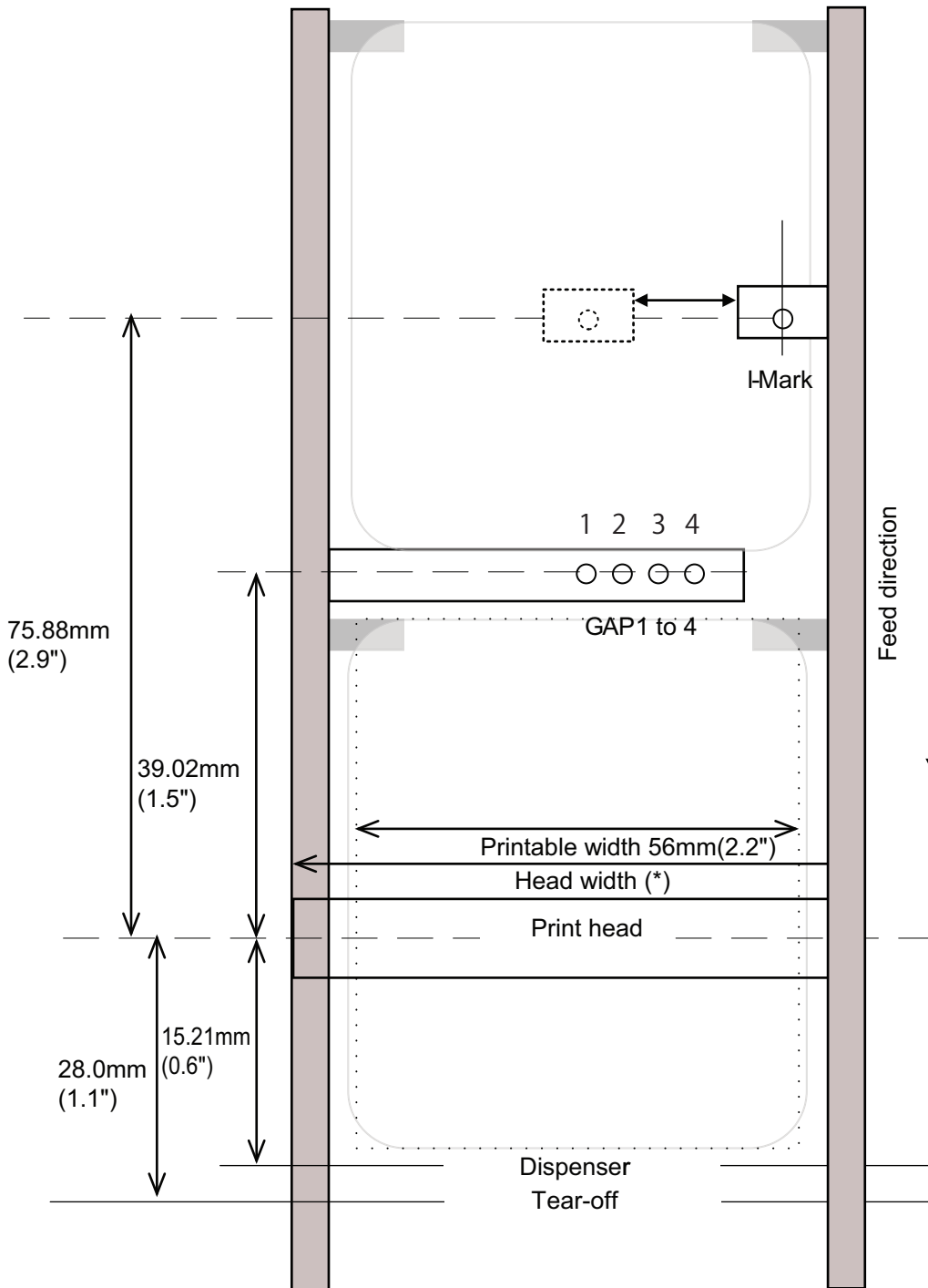

* Head width	
305 dpi	609 dpi
768 dot	1408 dot

## 8.2 OPERATION MODE SELECTION

---

There are three modes of printer operation: Continuous, Tear-off and Dispense mode. The differences are the ways in which the label and liner are ejected. Before printer configuration, one must determine which mode will be used. This section identifies the functional differences among the three.

### **CONTINUOUS MODE**

With this mode of operation, the media remains in position for printing at all times. To do so, means that the previous printed label is only available for removal when one to four additional labels have been printed (quantity depends on label size). This mode of operation is specifically suited for printing bulk quantities to be applied later on.

### **TEAR-OFF MODE**

With this mode of operation, after printing, the printer feeds the first (outermost) label so that it is fully extended out of the printer's front for removal. Printing of the next label will not begin until the prior printed label has been removed. This mode of operation is specifically suited for immediate application at the time of print.

Upon removal of the prior printed label, the printer retracts the media so that the next label in line may be printed, then the printer feeds it. This cycle repeats for each consecutive label.

### **DISPENSE MODE**

This mode of operation will peel the liner (paper backing) from the printed label as it is advanced to the printer's front. Once the printed label has been removed from the printer for application, the unprinted media will retract and position itself so the next label may be printed.

This operational mode is specifically applicable to print operations where the label is to be immediately adhered.

### 8.3 BASE REFERENCE POINT

---

The base reference point is the point at which one determines the print and cut positions. The base reference position differs, depending on the print mode or the label pitch sensor to be used.

#### 8.3.1 Continuous Mode

The base position for printing in continuous mode.

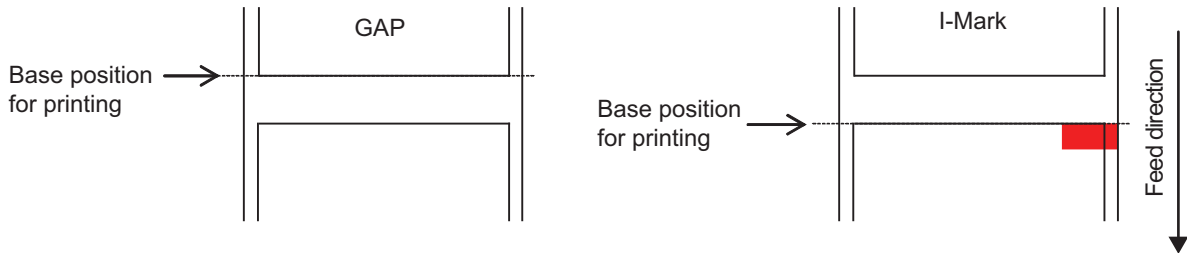

#### 8.3.2 Tear-off Mode

The base position for printing and manual cutting in Tear-off mode.

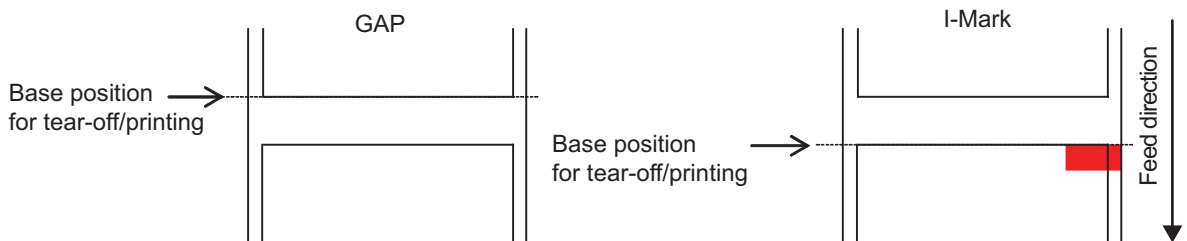

#### 8.3.3 Dispenser Mode

The base position for printing and dispensing in Dispenser mode.

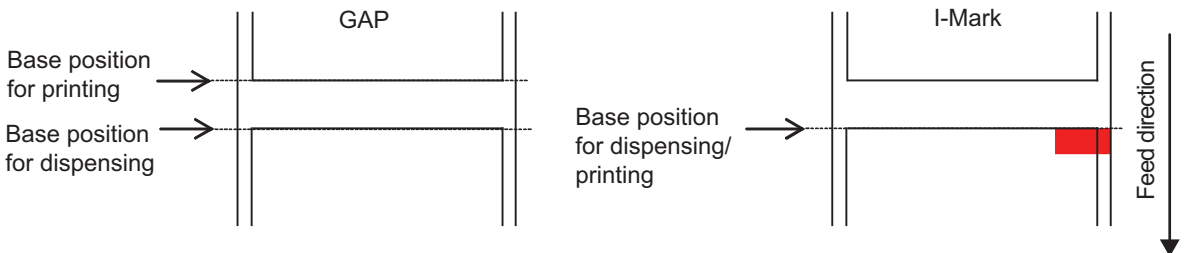



**8.4 BASE REFERENCE POINT ADJUSTMENT**

The offset function (print and stop) of the printer are as follows.

**8.4.1 Adjustment of Print Position**

Adjustments		
Base Position for Printing	Setup on LCD Adjustment mode: PITCH/ Test Print mode: PITCH POSITION	+3.75mm to -3.75mm (+0.15" to -0.15")

Label stop position (print position) is adjustable within the range of +3.75mm to -3.75mm (+0.15" to -0.15") due to the above settings on LCD screen.

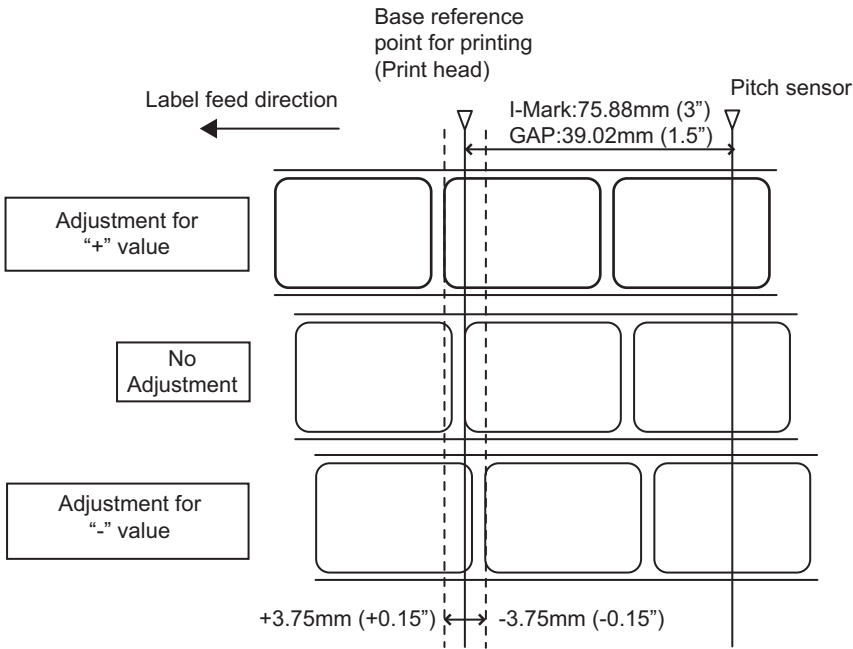

**Note**

The above base position for printing will be the stop position when the GAP sensor is selected.

## 8.4 BASE REFERENCE POINT ADJUSTMENT (Cont'd)

### 8.4.2 Adjustment of Stop Position When Using Dispenser/ Tear-off

Adjustments for Dispenser / Tear-off		
Stop position for Dispense/ Tear-off mode	Setup on LCD Adjustment mode: OFFSET / Test Print mode: OFFSET POSITION	+3.75mm to -3.75mm (+0.15" to -0.15")

Label stop position for optional devices is adjustable within the range of +3.75mm to -3.75mm (+0.15" to -0.15") due to the above settings on LCD screen

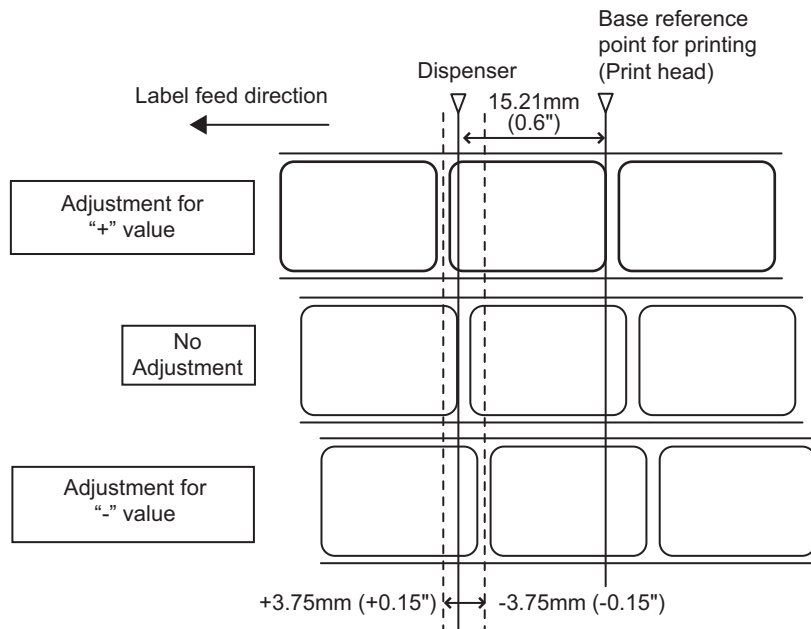

#### Notes

- The above dispense position will be the stop position when the GAP sensor is selected.
- Tear-off position is adjustable in the same manner.

**8.4 BASE REFERENCE POINT ADJUSTMENT (Cont'd)**

**8.4.3 Adjustment of Stop Position in Tear-off Mode (only for the first label)**

Adjustments		
Stop position in Tear-off mode (only for first label)	Set up on LCD Small pitch test print in Tear-off mode: TEAR OFF TOP POS	+3.75mm to -3.75mm (+0.15" to -0.15")
Stop position for Dispense/ Tear-off mode	Set up on LCD Adjustment mode: OFFSET/ Test Print mode: OFFSET POSITION	+3.75mm to -3.75mm (+0.15" to -0.15")

Label stop position (first label) for Tear-off mode is adjustable within the range of +7.5mm to -7.5mm (+0.15" to -0.15") due to the above settings on LCD screen

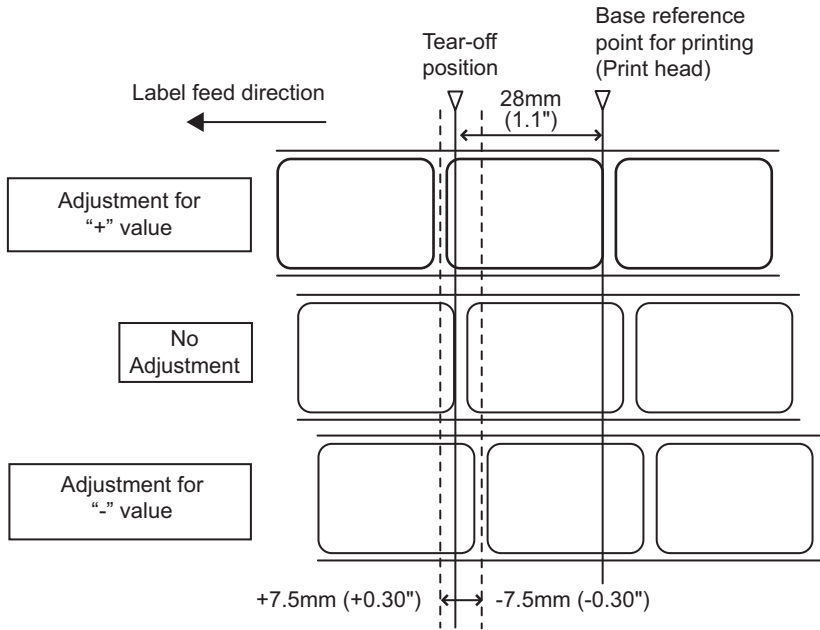

**Notes**

- Adjustment of first label stop position is available only in Tear-off mode.
- The above Tear-off position will be the stop position when the GAP sensor is selected.
- Tear-off stop position will be adjusted if the criteria listed below are satisfied.  
Power ON (when cover opened/closed just before powering off)  
Cover open/close  
Switching of sensor type (GAP<->I-MARK)  
Changing of GAP sensor number

## 8.5 PAPER END

### 8.5.1 Paper End Detection during Paper Feed

The Paper end switch detects “No paper” state and notifies paper end error after feeding 15mm.

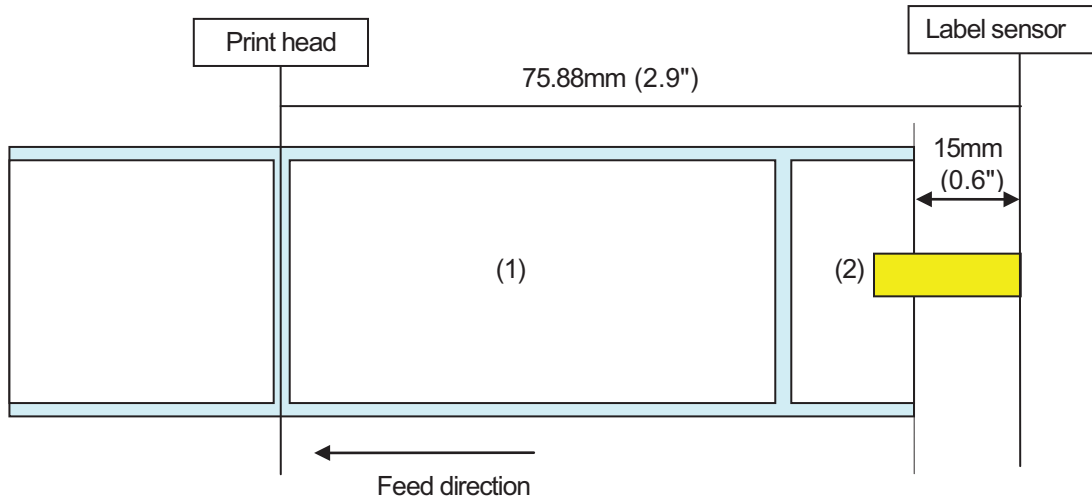

### 8.5.2 Paper end detection in print motion

When the Label End is less than 15mm (0.6") from the head position to the paper end sensor.

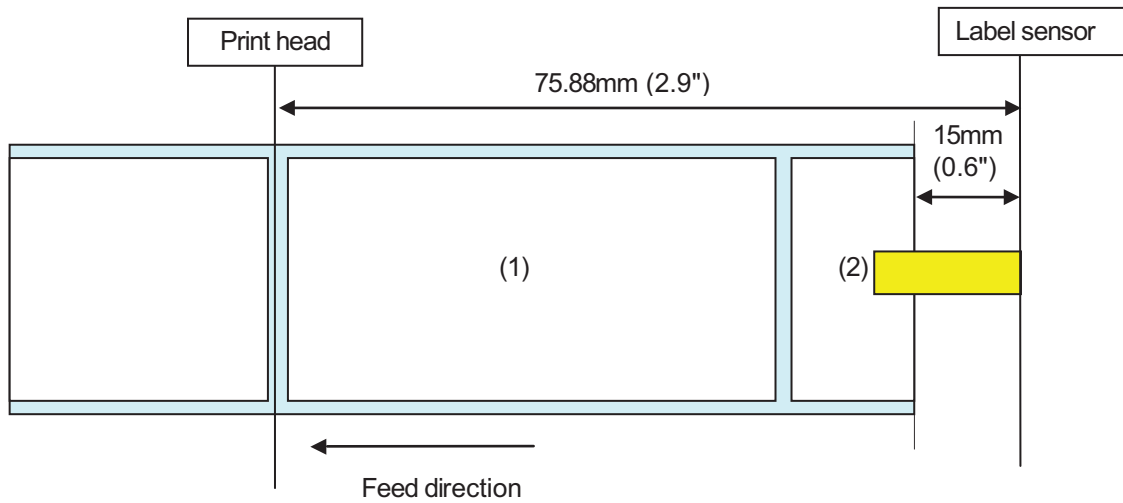

8.5 PAPER END (Cont'd)

Printing step between print head and label sensor: 75.88mm (2.9")-15mm (0.6") or less

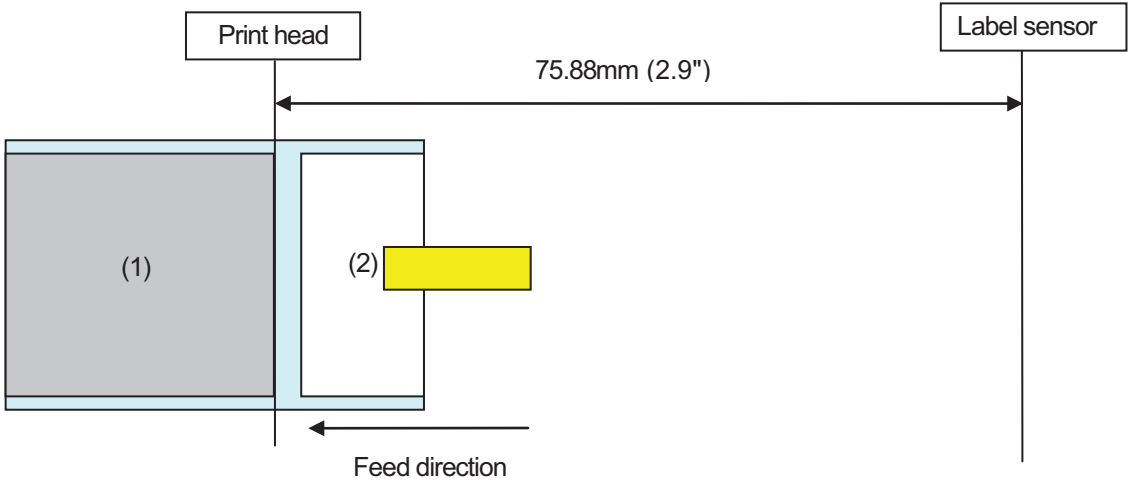

Printing step between print head and label sensor: 75.88mm (2.9")-15mm (0.6") or more

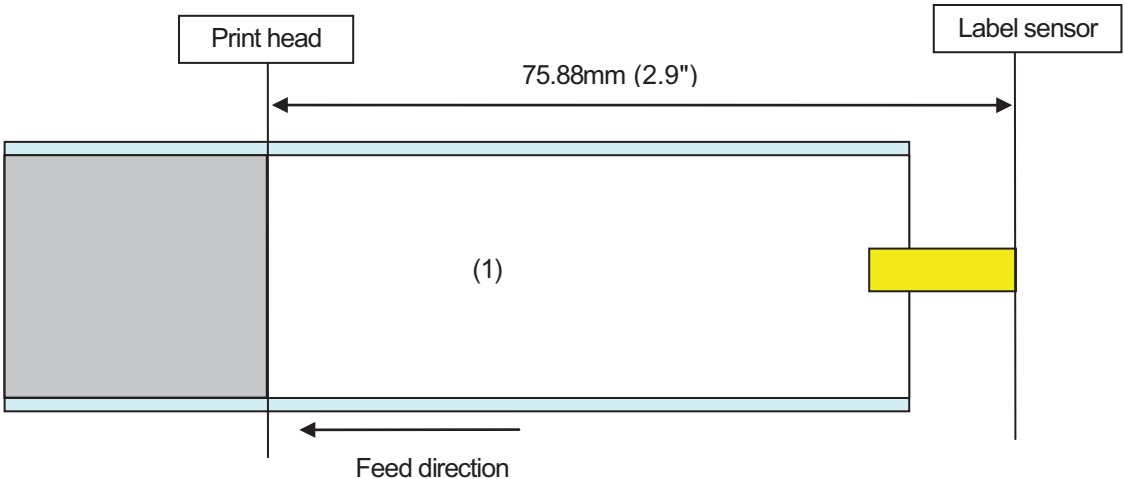

**Notes:**

- 1. Label sensor detects the status of "no paper" for 15mm (0.6") of paper feed.
- 2. If the printing step between print head and label sensor (75.88mm, 2.9") is 15mm (0.6") or less, the printer will indicate "Paper end" error after (1) has been printed.  
If the label pitch size between print head and label sensor (75.88mm, 2.9") is 15mm (0.6") or more, the printer will indicate "paper end" error soon after "paper end" is detected. Release the error to resume printing.

## 8.6 RIBBON END

---

The printer will indicate the ribbon end error after the ribbon slit sensor detection of the error and 5mm (0.2") feeding.

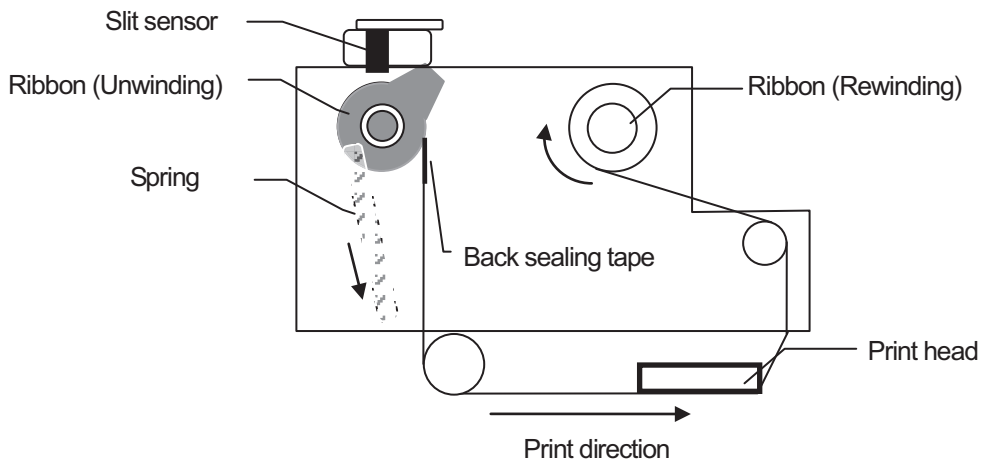
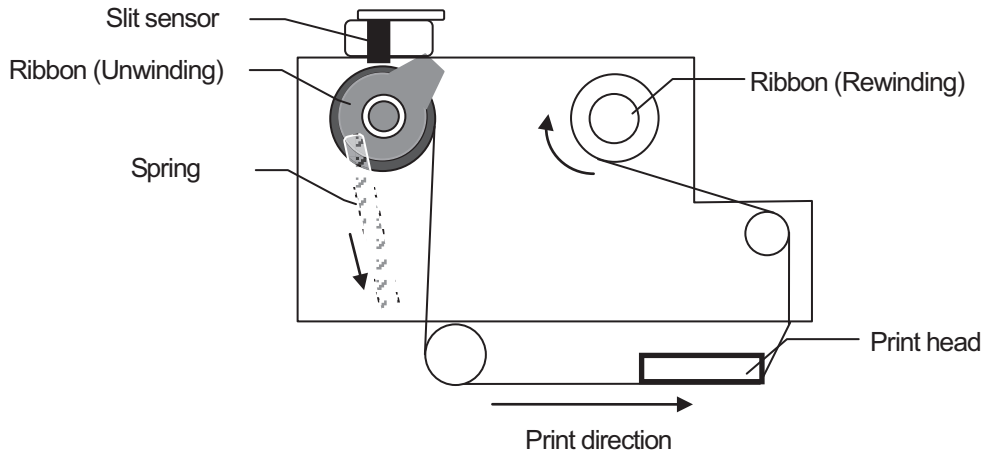

## 8.6 RIBBON END (Cont'd)

---

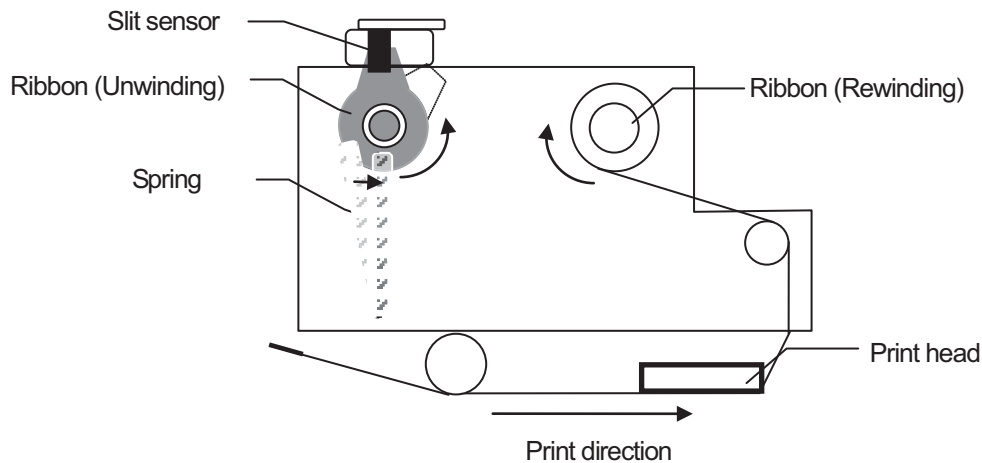

### Notes:

- The printer will not reprint even after the error is released if the printing has been completed during “ribbon end” error occurred.
- The printer will reprint after the error is released if the error is detected while printing.

## 8.7 REWINDER FULL

---

### 8.7.1 Detection of Rewinder Full

The printer checks rewinding sensor at 5msec cycle, however, it will not detect rewriter full error while controlling the print motion.

The printer will indicate “rewinder full” error when the state of “rewinder full” continues for approximately 50 msec. If the error occurs while printing, the printer will indicate “rewinder full” error after the printing is completed.

Rewinding capability is approximately 75m (246 feet) (with 100 $\mu$  liner).

### 8.7.2 Release of Rewinder Full Error

Press **FEED** button to release the error (move into Offline) and ignore the error state temporarily.

The printer can print 10 labels after the error is released. After 10 labels printed, the printer will indicate an error “to rewind”. The labels that have been fed will not be counted.



Extensive contact information of worldwide SATO operations can be found on the Internet at **[www.satoworldwide.com](http://www.satoworldwide.com)**