



# Quick Guide

for



## RWG500

rewinder for barcode printers

<http://www.satoworldwide.com>

---

## Introduction

---

Thank you for your purchase of the SATO RWG500 new generation rewinder for SATO barcode printers.

This quick reference guide will lead you on a familiarization tour to help you start using the machine as soon as possible.

To get the most out of the RWG500's intelligent features, make sure to read this manual carefully before using the machine.

## Table of Contents

---

Introduction .....	2
Safety Symbols .....	3
Safety Precautions .....	4
FCC Notice .....	6
What's In the Box .....	7
Parts Identification .....	8
Parts Identification .....	9
Preparing the Joint Plate .....	10
Adjusting the Roller Height .....	14
Installing the Joint Plate .....	15
Label Setup .....	17
Basic Operation .....	23
Winding 6" labels .....	25
Installing the 6" Expansion Kit .....	26
Basic Specifications.....	27



---

## Safety Symbols



---



### About warning symbols



As a preventive measure to ensure safe usage of this machine so as to safeguard against damage to yourself, other people or property, several symbols and icons are used in this guide. The following pages describe the significance of each symbol. Please take time to read and understand the content.

 <b>Warning</b>	If this display and its warning is ignored, any mishandling could result in death or serious injuries.
 <b>Caution</b>	If this display and its warning is ignored, any mishandling could result in serious injuries as well as damage to properties.





### Examples





  The triangle sign means 'Be careful'. The content within the triangle illustrates specific hazards. In this case, the sign on the left means 'beware of electric shock'.

  The circular sign means 'prohibited'. The content within the circle illustrates a specific prohibition. In this case the sign on the left means 'disassembly prohibited'.

  The black circular sign means 'must do'. The content within the sign illustrates specific items that must be carried out. In this case the sign on the left means 'the plug must be unplugged from the socket'.

## Safety Precautions

 <b>Warning</b>	<p>Do not place on an unstable place</p> <p>Do not place the rewinder on an unstable place such as an unsteady table, an inclined place or a place with vibration. The rewinder may drop or topple over and cause injuries.</p>
 <b>Caution</b>	<p>Liquids</p> <p>Do not place any containers with water or chemicals, such as flower vases or cups, as well as small metallic objects near the rewinder. Continued use creates the danger of fire or electrical shock.</p> <p>* If any of these should fall into the rewinder, immediately turn off the power and contact your nearest dealer or service center.</p>
 <b>Warning</b>	<p>Foreign Matter</p> <p>Do not drop or insert metallic or flammable objects into the openings on the rewinder. Continued use creates the danger of fire or electrical shock.</p> <p>* If any of these should fall into the rewinder, immediately turn off the power and contact your nearest dealer or service center.</p>
 <b>Caution</b>	<p>Dropping and Damage</p> <p>Do not use if the product has been dropped or damaged. Continued use creates the danger of fire and electrical shock.</p> <p>* Should the rewinder ever fall or otherwise become damaged, immediately turn off the power and contact your nearest dealer or service center. Continued use creates the danger of fire or electrical shock.</p>

 <b>Warning</b>	<p><b>Abnormal Conditions</b>  Do not use the rewinder if it is emitting smoke or strange odors. Continued use creates the danger of fire and electrical shock.  * Immediately turn off the power and contact your nearest dealer or service center for repairs. Do not try to service the rewinder by yourself.</p>
 <b>Caution</b>	<p><b>Disassembly</b>  Never try to take the unit apart or modify it in any way. Doing so creates the danger of fire or electrical shock. Contact your nearest dealer or service center for repairs.</p>
 <b>Warning</b>	<p><b>Location</b>  Do not locate the rewinder in areas subjected to high humidity or dew. Doing so creates the danger of electrical shock.  * If dew forms inside the rewinder, immediately turn off the power and do not use it until it has dried up.</p>
 <b>Caution</b>	<p><b>FOR CONTINUED PROTECTION AGAINST RISK OF FIRE.</b>  <b>REPLACE ONLY SAME TYPE AND RATING OF FUSE.</b>  <b>LOCATION : F1 , F2    RATING : 125V 3.5A</b></p>

---

The logo for the FCC Notice section, featuring the letters 'FC' in a stylized font with a circle around the 'C', followed by the text 'FCC Notice' in a bold, sans-serif font.

---

This equipment has been tested and found to comply with the limits for a Class B digital device, pursuant to Part 15 of the FCC Rules.

These limits are designed to provide reasonable protection against harmful interference in a residential installation.

This equipment generates use and can radiate radio frequency energy and, if not installed and used in accordance with instructions, may cause harmful interference to radio communications.

However, there is no guarantee that interference will not occur in a particular installation.

If this equipment does cause harmful interference to radio or television reception, which can be determined by turning the equipment off and on, the user is encouraged to try to correct the interference by one or more of the following measures:

- Reorient or re locate the receiving antenna.
- Increase the separation between the equipment and receiver.
- Connect the equipment into an outlet on a circuit different from that to which the receiver is connected.
- Consult the dealer or an experienced radio/TV technician for help.

---

## What's In the Box

---

RWG500 main unit



Joint plate



Label Clip



3-inch core x 2



EXT cable



Label Guide



Quick Guide

---

## Parts Identification

---

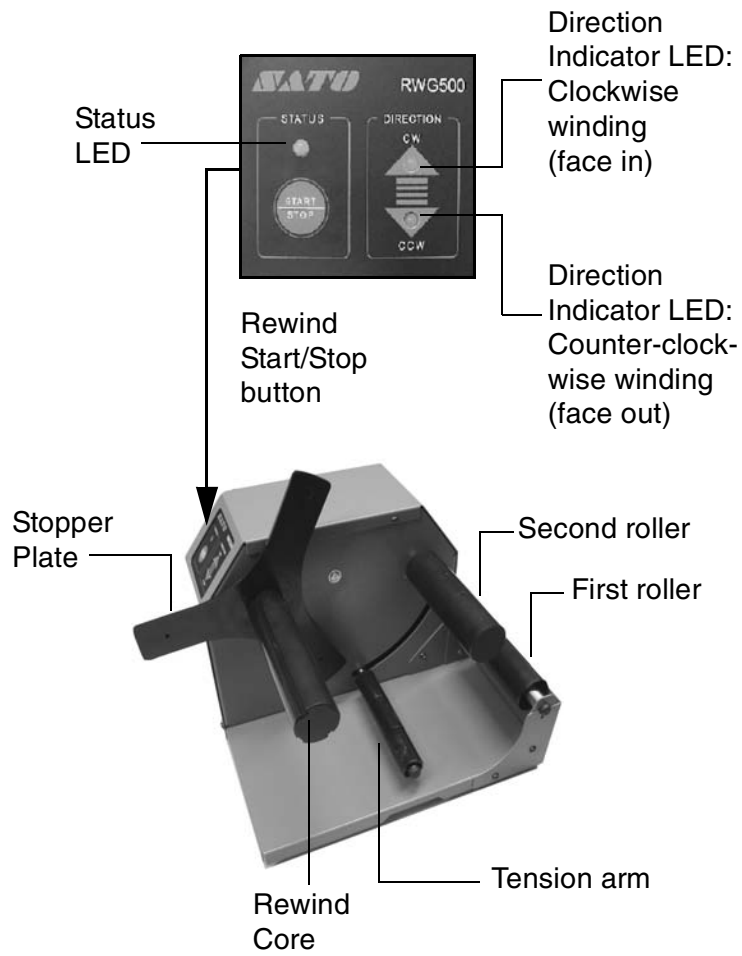



---

## Parts Identification

---

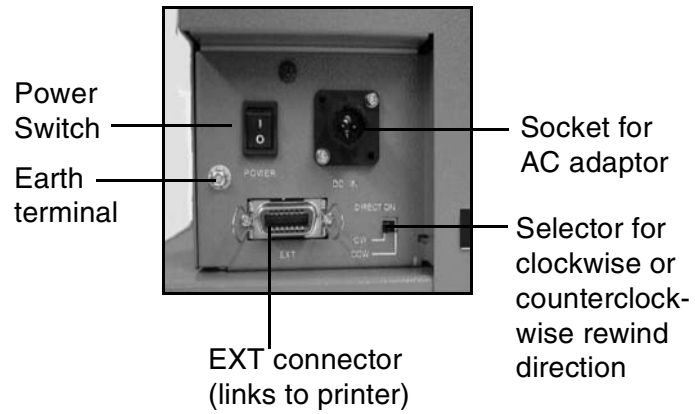

---

## Preparing the Joint Plate

---

The joint plate aligns the base of the RWG500 to the base of a SATO printer. This alignment ensures a smooth label path and prevents problems during long periods of continuous operation.

The following procedure adjusts the joint plate to suit the base of different SATO printers, as shown here:

- 1** Use a Phillips screwdriver to loosen the two screws that secure the movable portion of the joint plate.

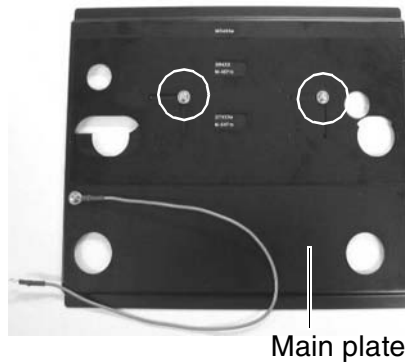

- 2** Slide the movable portion of the joint plate in various directions to reveal the names of various SATO printer models.

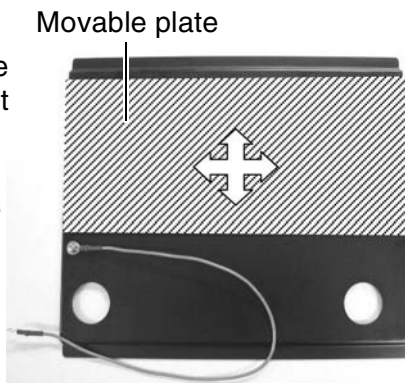

---

## Preparing the Joint Plate (cont'd)

---

To prepare the joint plate for a **GTx4XXe** or **M-84Pro** series printers:

When the movable plate reveals “GTx4XXe” and “M-84Pro”, adjust its position so that each protruding stub (called a boss) on the underside of the movable plate will fit neatly into two complementary holes on the main plate. The movable plate will not slide easily now. Tighten the two screws which were loosened in Step 1.

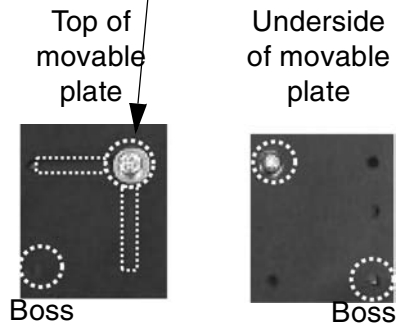
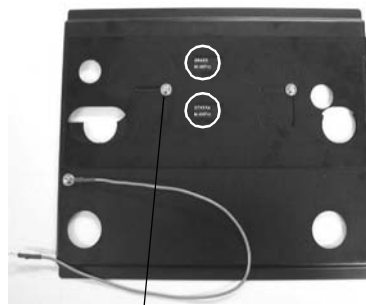

---

## Preparing the Joint Plate (cont'd)

---

To prepare the joint plate for the M-5900Rve printer:

When the movable plate reveals “MT4XXe” and “M-5900Rve”, adjust its position so that each protruding stub (called a boss) on the underside of the movable plate will fit neatly into two complementary holes on the main plate. The movable plate will not slide easily now. Tighten the two screws which were loosened in Step 1.

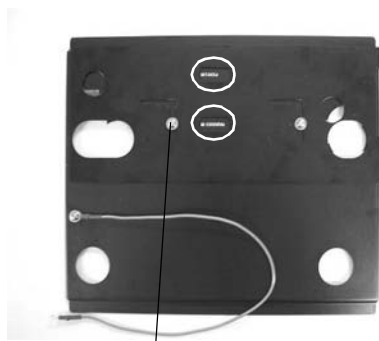

Top of  
movable  
plate

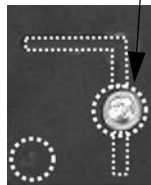

Boss

Underside  
of movable  
plate



Boss

---

## Preparing the Joint Plate (cont'd)

---

To prepare the joint plate for the CL6XXe series printers:

When the movable plate reveals “MR6XXe” and “CL6XXe”, adjust its position so that each protruding stub (called a boss) on the underside of the movable plate will fit neatly into two complementary holes on the main plate. The movable plate will not slide easily now. Tighten the two screws which were loosened in Step 1.

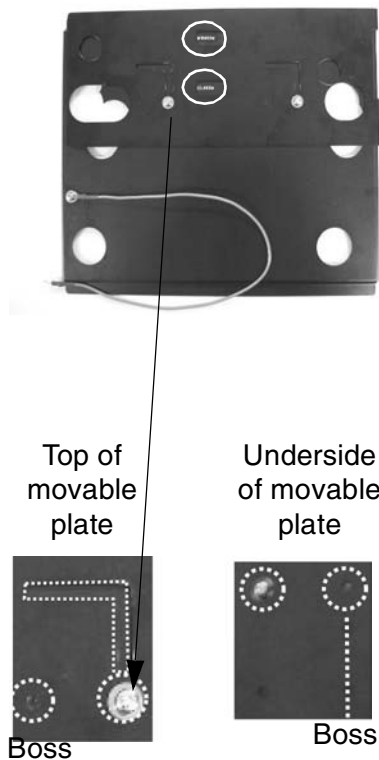

---

## Adjusting the Roller Height

---

Before the rewinder is guided into place in front of the printer, the height of its first roller has to be adjusted to one of two positions (upper or lower) to fit the printer, based on the table below:

### Roller Height settings for SATO Printers

Model	Roller Height
GTx4XXe	Lower position
CL6XXe	Lower position
CL4XXe	Upper position
M-84Pro	Upper position
M-5900Rve	Upper position

Roller in Upper position

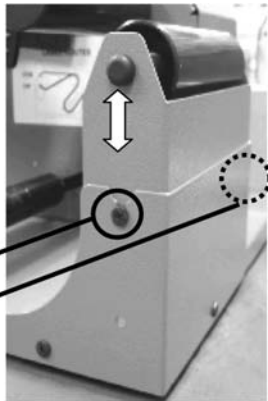

Install two locking screws here

Roller in lower position

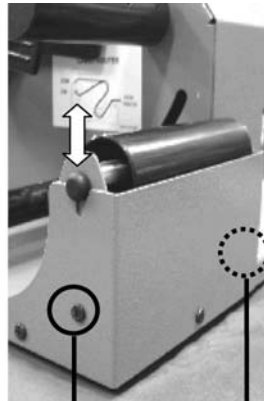

Install two locking screws here

---

## Installing the Joint Plate

---

To align the printer to the RWG500 using the joint plate:

- 1** Place the non-movable holes of the joint plate under the feet of the rewinder as shown. The holes of the movable plate should be facing away from the rewinder.



- 2** Connect the Frame Ground wire of the joint plate to the Earth terminal on the rewinder. Use a Phillips screwdriver if necessary.



Earthing completed

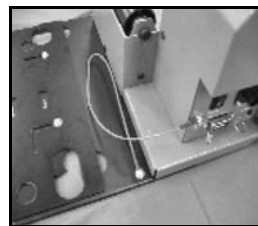

---

## Installing the Joint Plate (cont'd)

---

- 3** Now place the printer so that its feet at the label output side will fit into the positioning holes on the joint plate.

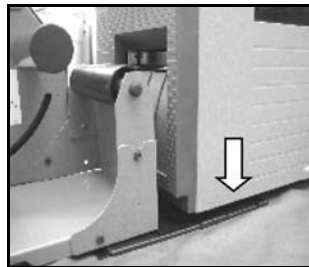

- 4** Make sure both the printer and the rewriter are turned OFF. Locate the EXT connector of the printer and use the supplied EXT cable to connect the printer to the rewriter's EXT connector.



 **Caution**

Make sure that the printer and rewriter are aligned properly using the joint plate. Otherwise rewinding errors may occur.

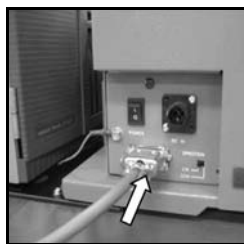



---

## Label Setup

---

The RWG500 offers two rewind directions and two types of rewind shafts, as follows:

**Rewinding Direction: Face in (CW) / Face Out (CCW)**  
**Rewinding Shaft: Direct rewind/3" paper core rewind**

### About Rewinding Direction

Counterclockwise  
winding (CCW)

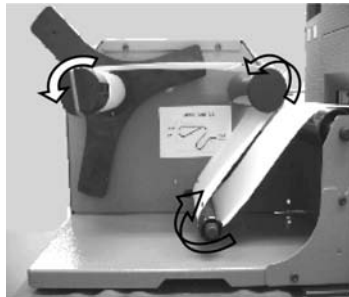

In a CCW winding direction, the printed surface of the label is always visible as it faces outwards.

Clockwise  
winding (CW)

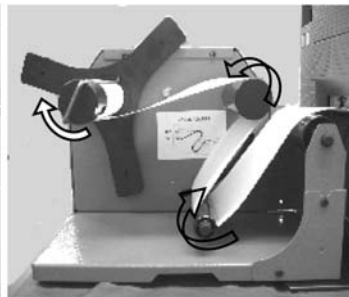

In a CW winding direction, the printed surface of the label faces inwards and is hidden from view. Only the backing sheet (label liner) faces outwards. The rewind is set by default to CW rewinding.

---

## Label Setup (cont'd)

---

To change the rewind direction, use the Direction switch found on the side panel of the rewinder. **The factory setting is CW rewinding by default.**

### Setting Rewind Direction

1. Before changing the rewind direction, make sure the rewinder is turned OFF, or make sure that the Status LED is blinking in green (rewinder in Idling state)
2. Locate the Direction switch at the side panel, and set it to either CW (clockwise, face in) or CCW (counterclockwise, face-out).
3. Check the control panel display to confirm that the appropriate CW or CCW LED is lit.

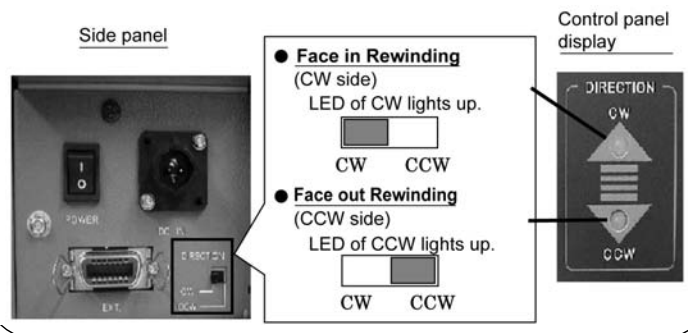

### Caution

Change the rewind direction only when the rewinder is in an idling state, or when it is turned OFF.

---

## Label Setup (cont'd)

---

Besides setting the rewind direction, you can set up the rewinder for direct rewinding or rewinding using a 3" paper core.

### About Direct Rewinding

Use direct rewinding when a paper core is not to be used, and the label being collected will not need reprinting or reprocessing in future.

**1** Set the rewinder for CW or CCW rewind direction and load the label accordingly. Wind the label at the rewinding shaft, and insert the provided label clip to fasten the label onto the shaft.

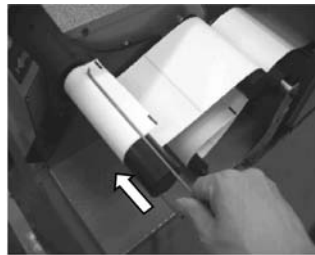

**2** Now insert the label guide. The label output from the printer is now set for direct rewinding.

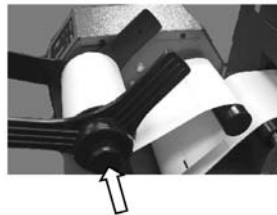

---

## Label Setup (cont'd)

---

You can collect output labels onto a 3" paper core for more consistent winding, and if the wound label needs to be unwound later for reprocessing/reprinting.

### Rewinding on a 3" paper core

**1**

If label width is below 65 mm, attach one of the provided 3" core adaptors to the rewinding shaft. Otherwise, use two adaptors. The adaptor(s) should be inserted so that the metal plate teeth faces in the same direction\* as the rewind direction. Screw the adaptor(s) into the narrow groove of the shaft.

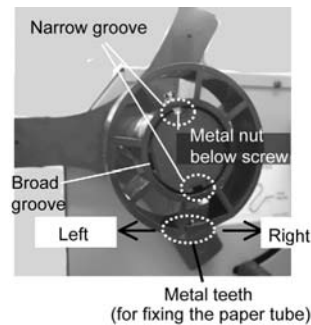

**\* For CW and CCW rewinding, the metal teeth must face left or right respectively.**

**2**

Space the adaptor(s) along the shaft to fit the label width, then tighten each locking screw. Make sure the screw fits into the metal nut sliding along the groove.

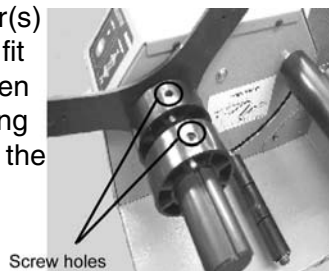

---

## Label Setup (cont'd)

---

After properly inserting the 3" core adaptor(s), follow the steps below to install the label.

- 3** Insert the 3" paper tube core into the rewind shaft. Affix the leading (front) portion of the output label to the paper core with some adhesive tape.

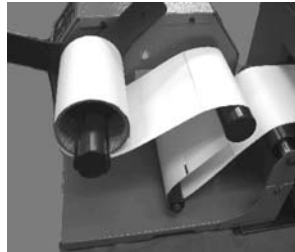

- 4** Finally, insert the label guide.

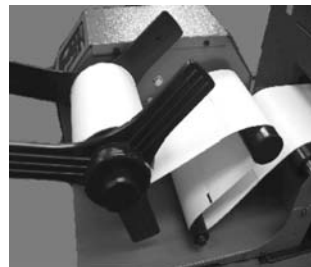

 **Caution**

Before installing any label, always make sure that the rewinder is OFF, or in an idling state (Status LED blinks green).

---

## Basic Operation

---

After setting up the rewinder to work with your SATO printer, rewinding can be performed.

**1** Turn on the rewinder. Wait for the status LED on the control panel to start blinking in green. The rewinder is now in idling status—ready to collect labels from the printer.

**2** Press and hold down the START/STOP button on the rewinder control panel. The rewind shaft starts rotating, and the tension arm rises and stops automatically. This process takes up any slack in the label path.



When the Status LED is lit in green continuously, release the Start/Stop button. The rewinder is now in operation.

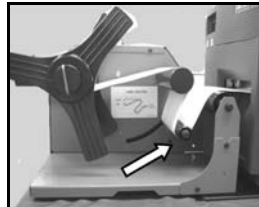

If you release the Start/Stop button before the Status LED lights up continuously in green, repeat Step 1.

---

## Basic Operation (cont'd)

---

**3**

Start the automatic rewinding by printing labels on the printer. Each time a label is printed, the rewinder automatically winds it outwards and takes up any slack in the winding process.

**4**

When the rewinding is completed, press the START/STOP button on the rewinder's control panel. The tension arm comes to rest and stops automatically. The Status LED blinks in green to signal the rewinder's **idling status**.

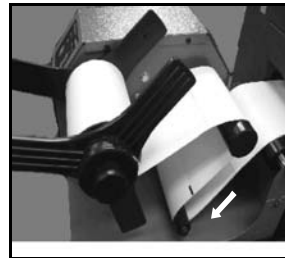

**5**

Remove the label on the printer, and then remove the wound label on the rewinder. The wound label can be removed easily because the tension arm is inactive.

---

## Winding 6" labels

---

To wind labels wider than 131 mm, the optional 6" Expansion Kit is required. The kit consists of the following:

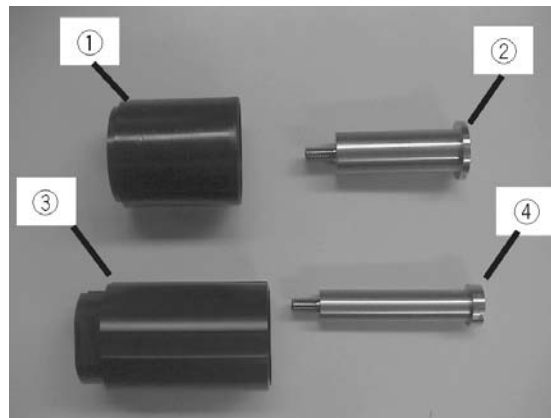

- ① Second roller joint
- ② Second roller shaft guide
- ③ Core joint
- ④ Core shaft guide



---

## Installing the 6" Expansion Kit

---

Follow the steps below to install the Expansion Kit.

- 1** Remove the cap covering the second roller of the rewinder.



- 2** Insert the kit's second-roller joint and second-roller shaft guide. Tighten the shaft guide in a counter-clockwise direction using a screwdriver.

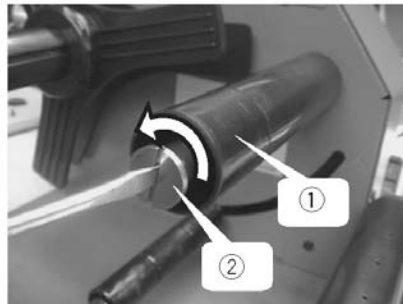

- 3** Reattach the cap.

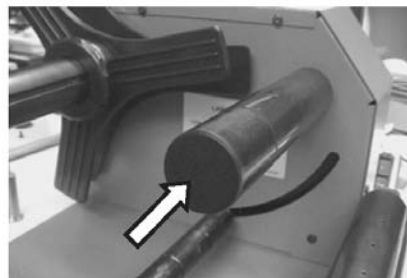

---

## Installing the 6" Expansion Kit (cont'd)

---

- 4** Remove the cap covering the rewinding shaft of the rewinder.

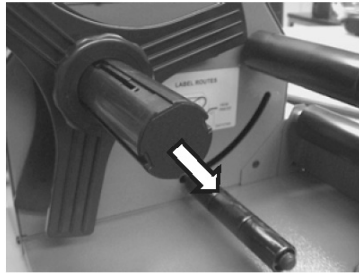

- 5** Insert the core joint and core shaft guide. Tighten the shaft guide in a counterclockwise direction using a screwdriver.

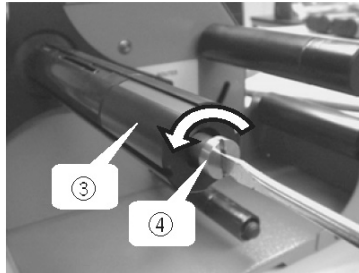

- 6** Reattach the cap to complete installation of the expansion kit.

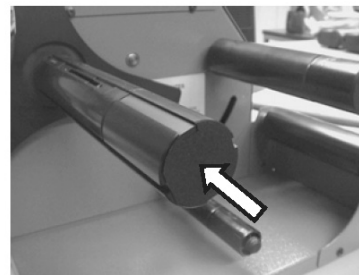

---

## Basic Specifications

---

<b>Rewinding method</b>	<ul style="list-style-type: none"> <li>• Ø 38.1 mm direct rewinding</li> <li>• 3" paper core rewinding</li> </ul>	
<b>Paper type</b>	Supports all genuine SATO labels printed on SATO printers, except linerless labels	
<b>Paper width</b>	Width: 25–131 mm (standard) Width: 25–180 mm w/optional expansion kit. Label thickness: 0.08–0.26 mm	
<b>Winding direction (selectable)</b>	<ul style="list-style-type: none"> <li>• Default setting: Face in (CW)</li> <li>• Face out (CCW)</li> </ul> <b>Note:</b> Rewind direction must match the winding direction of the label produced from the printer.	
<b>Rewind speed</b>	Auto speed setting, up to max of 381 mm/s	
<b>Rewind monitoring</b>	Tension arm detects paper slack, paper presence and incoming paper speed	
<b>Power Supply</b>	DC25V	<b>Standard:</b> Power tapped from SATO printer's EXT port <b>Option:</b> AC adaptor designed for RWG500
<b>External diameter</b>	Width (W) 280 mm Depth (D) 320 mm Height (H) 230 mm	
<b>Weight</b>	7.5kg	