

MB400//410i  
Direct Thermal  
Printer



---

**Operator's Manual**

© Copyright 2007. All rights reserved. No part of this document may be reproduced or issued to third parties in any form whatsoever without the express permission of SATO International. The materials in this document is provided for general information and is subject to change without notice. SATO International assumes no responsibilities for any errors that may appear.

**Warning:** This equipment complies with the requirements in Part 15 of FCC rules for a Class B computing device. Operation of this equipment in a residential area may cause unacceptable interference to radio and TV reception requiring the operator to take whatever steps are necessary to correct the interference.



**SATO International Pte Ltd  
438A Alexandra Road  
#05-01/02, Alexandra Technopark  
Singapore 119967  
Phone: +65 (6271) 2122  
Fax: +65 (6271) 2151  
[www.satoworldwide.com](http://www.satoworldwide.com)**

Version: SI-MB40xi-01rA-10-07-OM

## Safety Precautions

---

As a preventive measure to ensure safe usage of this machine so as to safeguard against damage to yourself, other people or property, there are many display diagrams used in this instruction manual and on this machine. The displays and their meanings are illustrated in the following pages. Please take time to read and understand the content.

 <b>Warning</b>	If this display and its warning is ignored, any mishandling could result in death or serious injuries.
 <b>Attention</b>	If this display and its warning is ignored, any mishandling could result in serious injuries as well as damage to properties.

# Safety Precautions

---

## Explanation of hazard symbols

 The triangle sign means 'Be careful'. The content within the triangle illustrates specific hazards. In this case, the sign on the left means 'beware of electric shock'.



 The circular sign means 'prohibited'. The content within the circle illustrates a specific prohibition. In this case the sign on the left means 'disassembly prohibited'.



 The black circular sign means 'must do'. The content within the sign illustrates specific items that must be carried out. In this case the sign on the left means 'the plug must be unplugged from the socket'.



## Warning

---

### **Liquids**

Do not place any liquids or small metallic objects near the printer. Should any of these fall into the printer, immediately turn off the power and contact your nearest dealer or service center. Continued use increases the risk of fire or electric shocks.

### **Foreign Matter**

Do not insert or drop metallic or flammable objects into the openings of the printer (such as outlets for cables). If this happens, immediately turn off the power and contact your nearest dealer or service center. Continued use increases the risk of fire or electric shocks.

### **Foreign Matter**

Should the printer be dropped or become damaged, immediately turn off the power and contact your nearest dealer or service center. Continued use increases the risk of fire or electric shocks.

## **Warning**

---

### **Abnormal Conditions**



Continued use of the printer while it is emitting smoke or strange odors increases the risk of fire or electric shocks. Immediately turn off the power and contact your nearest dealer or service center. Do not try to service the printer by yourself.

### **Disassembly**



Never try to take the unit apart or modify it in any way. Doing so increases the risk of fire or electric shocks. Contact your nearest dealer or service center for repairs.

### **Battery care**



Never try to take apart the battery pack or modify it in any way. Never expose the battery to direct heat or fire, or take any actions that may lead to physical damage. When charging the battery pack, be sure to use the printer or the specified battery charger.

## Warning

---

### **Power Supply Precautions**

- Use only the specified voltage and use only the specified battery charger.
- Never use the battery charger with any other battery pack except for the specified type. Doing so can rupture the battery, or cause leakage, fire or electric shocks.
- Never cut, damage or modify the power cord. Also, never place heavy objects on the power cord or heat or pull the power cord. Doing so may damage the cord.
- Should the power cord ever become seriously damaged (internal wiring exposed or shorted), contact your nearest dealer or service center for repair.
- Never modify, excessively bend, twist, or pull the power cord.

Continued use of the printer in any of the above situations can lead to increased risks of fire or electric shocks.

## Caution

---

### **Location**

Do not locate the printer in the area subjected to high humidity or dew. If dew forms inside the printer, immediately turn off the printer and do not use it until all moisture has dried up. Continued use creates the danger of electric shock or the printer damage.

### **Power**

Do not use wet hands to operate the power switch, replace the battery pack or unplug the AC adapter or battery charger. Doing so increases the risk of electric shock.

### **Hazardous parts**

- The entire thermal head gets very hot after printing. Avoid touching any part of it when replacing paper or cleaning the printer.
- Do not try to replace the thermal head by yourself.
- The cutter contains a blade, so be careful not to get cut by the sharp blade.



## **Caution**

---

### **Replacing the Battery Pack**

- Use only specified replacement battery packs.
- Make sure to install the pack in the correct direction to avoid the danger of injury or damage to surrounding areas.
- To replace small-size rechargeable (Lithium ion) batteries, seal the old battery pack with tape and ask our sales representative or service center about disposal methods. Do not place the battery pack together with other batteries such as dry batteries.

### **Long periods of non usage**

If you have no plan to use the printer for a long time, remove the battery pack from the printer and unplug the AC adapter from the wall outlet if you were using the AC adapter as the power source.

### **Maintenance and Cleaning**

For safe maintenance or cleaning of the printer, make sure to remove the battery pack and the AC adapter from the printer if you were using the AC adapter as the power source.

## Other Precautions

---

### **Avoid placement in extreme temperatures**

Do not place the printer in highly humid areas or at outside the -15°C to 50°C temperature range.

### **When the printer is being transported...**

The normal vibration encountered during transportation is acceptable, but avoid dropping the printer or exposing it to extreme vibrations.

### **Do not disassemble or modify the printer**

The printer has high-precision components inside requiring fine adjustments.

### **Use only the specified cables**

Special cables are required to connect to external equipment through the external input terminals. Contact your nearest dealer or service center if necessary.

### **Use only specified options**

Do not use a device not specified as option.

### **Use the specified paper**

Use the specified paper to avoid printing errors and to avoid damaging the print head.

# TABLE OF CONTENTS

Safety Precautions .....	iii
Explanation of hazard symbols .....	iv
Warnings .....	v
Cautions .....	viii
Replacing the Battery Pack .....	ix
Other Precautions .....	x

## 1. Overview

Notes on Bluetooth/Wireless Communication .....	1-2
Safety Precautions .....	1-3

## 2. Setup

Unpacking the printer .....	2-1
Part Names .....	2-2
Functions of various parts .....	2-4
Charging the battery pack with a charger.....	2-5
Charging the battery pack with the printer.....	2-7
Using the battery pack .....	2-8
Using the optional AC Adapter for power.....	2-10

## 3. Operation and Configuration

Performing a Test Print .....	3-2
Printing via the RS-232C Interface.....	3-3
Printing via the IrDA Interface .....	3-4
Printing via the Wireless LAN Interface.....	3-5
Printing via the Bluetooth Interface .....	3-6
Optional LCD screen .....	3-7
Printing Procedure .....	3-9

Adjusting printing for linerless labels .....	3-10
Choosing the Label Dispensing mode .....	3-11
Configuring Dispense mode .....	3-12
Other Printer Modes .....	3-13
Offset Configuration via Programming.....	3-17

#### **4. Special Settings**

#### **5. Cleaning and Maintenance**

Cleaning the Print Head .....	5-1
Cleaning the Platen and Peel Roller.....	5-2

#### **6. Troubleshooting**

#### **7. Basic Specifications & Optional Accessories**

Basic Specifications.....	7-1
Optional Accessories .....	7-9

## OVERVIEW

---

This manual is intended to familiarize you with the basic features and operation of the **MB400i/410i** barcode printer in a short time.

### **Key features:**

- High speed CPU and 103 mm/sec print speed (max)
- Available in 203 dpi and 305 dpi resolutions
- Long battery life
- Durable and rugged design
- Supports media up to 114 mm in width
- Built-in label dispenser (peeler)
- Available in USB, IrDA, RS232c, Bluetooth 1.1, IrOBEX and IEEE802.11 b/g interfaces
- Supports the MB400-compatible Programming Language or Sato Basic Programming Language of the advanced SATO desktop printers

Please read this manual\* carefully to make full use of this product.

*\* All information herein was correct at the time of this document's release. Revised versions of this document are created to match updates in firmware and procedures.*

### **Notes on Bluetooth/Wireless Communication**

#### **Compliance Statement**

This product has been certified for compliance with the relevant radio interference regulations of your country or region. To ensure continued compliance, do not:

- Disassemble or modify this product
- Remove the certificate label (serial number seal) affixed to this product

Use of this product near microwave and/or other wireless LAN equipment, or where static electricity or radio interference is present, may shorten the communication distance, or even disable communication.



"Bluetooth" is a trademark of Bluetooth SIG, Inc., USA., and is used herein under licence.

**Caution:** Before using the wireless LAN interface, make all the security settings of the wireless LAN equipment are configured in accordance with the instructions supplied with the equipment.





## Safety Precautions

---

This section outlines the safety precautions needed for safe operation of the printer. Make sure to read the precautions carefully before using the printer.

### Symbols used in this Manual:

The following symbols or markings are used in this manual and on the printer so that you can properly use the printer, and to prevent any damage to property, harm or injury to yourself and others.

Symbol	Meaning
	<p>All safety symbols are enclosed by a circle or triangle. A black circle is for an action you <b>should</b> do. A white circle with a bar across it represents an action you <b>should not</b> do. A triangle indicates that care is needed for that action, to avoid potential hazards.</p>
	<p>This symbol comes with the word <b>Warning</b> or <b>Caution</b> to alert the user to be careful about an action to prevent (possible) damage or injury.</p>
	<p>This symbol alerts the user about the (possible) risk of electrical shock if care is not observed when performing a certain action.</p>
	<p>This symbol indicates that the user should remove the AC cord by pulling the plug and not the cord.</p>
	<p>This symbol indicates that the user should NOT attempt to dismantle or service the product.</p>











# Overview

## Usage Safety







- **Do not place the printer in a hot or cold place**  
The operation temperature range is -15°C to 50°C (for wireless LAN: 0 to 50°C) where humidity does not cause condensation. Do not place the printer in an area with high humidity or at a temperature outside the specified range.
- **Do not drop or apply undue shock to the printer**  
The printer is generally resistant to vibration possibly caused during normal transportation. However, do not apply extreme vibration or shock by dropping the printer.
- **Do not disassemble or modify the printer**  
The printer has high-precision components inside requiring fine adjustment.
- **Connect the correct cables to the input terminals**  
Cables of the correct specifications are required for connection to the external equipment through the external input terminals. Contact your nearest dealer or service center if necessary.
- **Use the recommended accessories**  
Using optional equipment other than the specified equipment may cause a malfunction. Always use the equipment specified in this guide.
- **Use the correct media**  
Use the specified media. Otherwise, faulty printing or printer damage may occur.







## Usage Warnings

<p><b>Liquids</b></p> 	<p>Do not place any container with water or chemicals, such as flower vase or cup, as well as small metallic objects, near the printer. If any of these should drop into the printer, immediately turn off the power and contact your nearest dealer or service center. Continued use creates a danger of fire or electric shock.</p>
<p><b>Foreign Matter</b></p>   	<p>Do not drop or insert metallic or flammable objects into the openings on the printer (such as outlets for cables). If any of these should fall into the printer, immediately turn off the power and contact your nearest dealer or service center. Continued use creates a danger of fire or electric shock.</p>
<p><b>Physical Shock</b></p>   	<p>Should the printer ever be dropped or otherwise become damaged, immediately turn off the power and contact your nearest dealer or service center. Continued use creates a danger of fire or electric shock.</p>
<p><b>Abnormal signs</b></p>  	<p>Continued use of the printer while it is emitting smoke or strange odors creates the danger of fire or electric shock. Immediately turn off the power and contact your nearest dealer or service center. Do not try to service the printer by yourself.</p>
<p><b>Disassembly</b></p>  	<p>Never try to take the unit apart or modify it in any way. Doing so creates the danger of fire or electric shock. Contact your nearest dealer or service center for checking, adjustment, or repair.</p>





## Overview

<p><b>Battery Pack</b></p>    	<ul style="list-style-type: none"><li>• Never try to take apart the battery pack or modify it in any way such as with a solder iron.</li><li>• Never expose the battery to fire, or take any actions that may lead to shorting.</li><li>• When charging the battery pack, make sure to use the printer or the specified battery charger.</li></ul>
<p><b>AC Adapter/ Battery Charger (Option)</b></p>   	<ul style="list-style-type: none"><li>• Use only the specified voltage. Using a different voltage may create the danger of fire or electric shock.</li><li>• Use only the specified AC adapter. Using a different adapter unit may create the danger of fire or electric shock.</li><li>• Never use the battery charger with any other battery pack except for the specified unit. Doing so can rupture the battery, cause leakage, or cause fire or an electric shock.</li><li>• Never cut, damage or modify the power cord. Also, never place heavy objects on the power cord or heat or pull the power cord. Doing so may damage the cord and create the danger of fire or electric shocks.</li><li>• Should the power cord ever become seriously damaged (internal wiring exposed or shorted), contact your nearest dealer or service center for repair. Continued use of such a cord creates the danger of fire or electric shock.</li><li>• Never modify, excessively bend, twist, or pull the power cord. Doing so creates the danger of fire or electric shocks.</li></ul>

## Usage Precautions

<b>Location</b> 	Do not locate the printer in areas with high humidity or dew. If dew forms inside the printer, immediately turn it off, and do not use it until the dew has dried up. Otherwise, continued use creates the danger of electric shocks or the printer damage.
<b>Power</b>  	<ul style="list-style-type: none"><li>• Do not use wet hands to operate the power switch, replace the battery pack or unplug the AC adapter or battery charger. Doing so creates the danger of electric shocks.</li><li>• The AC adapter set provided for this printer is specific to this printer. Do not use it for other electrical equipment.</li></ul>
<b>Print Head</b>  	<ul style="list-style-type: none"><li>• The print head gets very hot after printing. To avoid burns, take care when replacing the label or cleaning the printer just after printing.</li><li>• Touching the end of the print head with bare hands may cause injury. Take care when replacing the label or cleaning the printer.</li><li>• Do not try to replace the print head by yourself. Doing so creates the danger of injury, burns, or electric shocks.</li></ul>

## Overview

<p><b>Battery Pack</b></p>  	<ul style="list-style-type: none"><li>• When replacing the Battery Pack use only the specified design.</li><li>• Make sure to install the pack in the correct orientation. Incorrectly replacing the battery creates the danger of injury or damage to surrounding areas, if an explosion is caused.</li><li>• To dispose of a small rechargeable battery (Lithium ion battery), seal the metal contacts with tape and ask our sales representative or service center for the measures to be taken to recycle the reusable materials. Do not place the battery pack together with other batteries such as dry batteries.</li></ul>
<p><b>Storage</b></p> 	<p>If you have no plan to use the printer for a long time, remove the battery pack from the printer and/or unplug the AC adapter from the wall outlet before storing the printer (if you were using the AC adapter as the power source).</p>
<p><b>Maintenance</b></p> 	<p>For safe maintenance or cleaning of the printer, make sure to remove the battery pack and the AC adapter from the printer.</p>

# SETUP

---

## Unpacking the printer

If any component shown here is missing, contact your nearest dealer or service center.

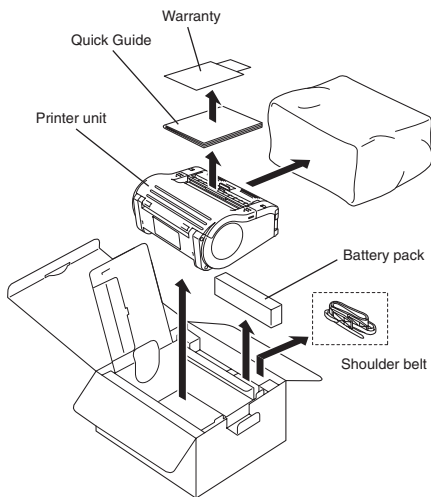

### Notes:

The printer is shipped with an integrated belt holder. Cushioning material may vary for different regions. An external battery charger is available separately.

# Setup

## Part Names

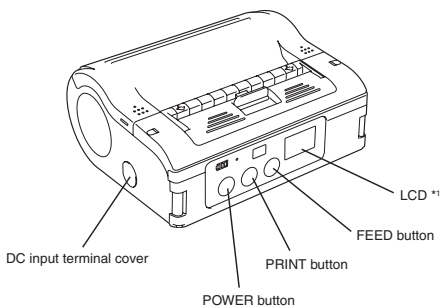
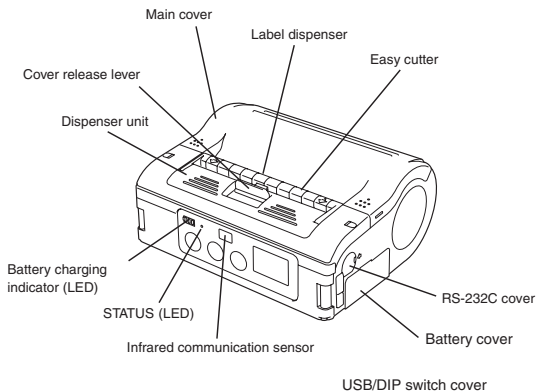

\*1 Only the WLAN model comes with an LCD screen

## Part Names (cont'd)

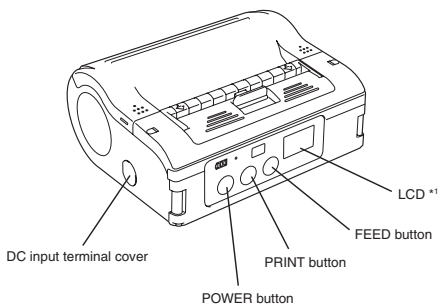
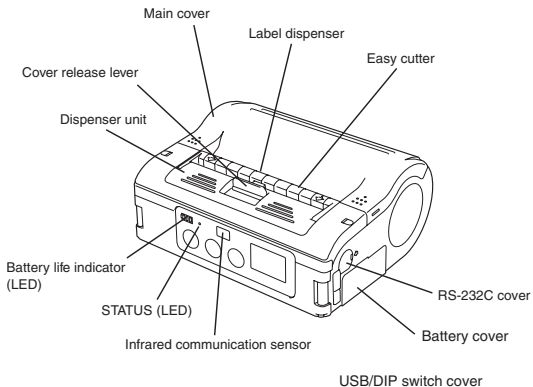

# Setup

## Functions of various parts

RS-232C Interface	Allows connection to a computer or handy terminal	Label guide	Set to meet the size of the label used
RS-232C cover	Protects the RS-232C connector from dust and damage	Label guide adjust dial	Allows adjustment of the label guide to fit the width of an installed label roll
Cover	Opens up to allow the installation of labels	Cover for Label guide adjust dial	Protects the label guide adjustment dial from dust or damage
Cover Open/Close lever	Enables the user to releases the cover, or to lock the cover shut	Label output area	This is the area where the printed label is output
Easy cutter	Cuts printed labels	Label width markings	Indicates the width of label installed or in use.
IrDA filter	Contains the IrDA (infrared) sensor and emitter	DC input jack	Connects to AC adapter which supplies direct current to the printer
DIP switch	Sets the operation mode of the printer. (See page 4-1.)	Cover for DC input jack	Protects the DC input terminal and DIP switch fro dust and damage
Dispenser unit	Moved to select Dispense mode	FEED button	Press to feed label
POWER button	Allows the user to turns ON/OFF the printer	PRINT button	Takes the printer Online or Offline
Battery cover	Cover for special battery pack	Status LED	Indicates the status of the printer. (See pages 3-13,3-14, 6-1 and 6-2)
Battery life indicator (LED)	Indicates the amount of battery power remaining for the printer	Belt clip	Suspends the printer on a belt, to allow greater mobility  * Do not hang the printer on to anything but a belt



## Charging the battery pack with a charger

If your printer comes with the optional battery charger, you can use it to charge the supplied battery pack. Follow the steps below:

1. Connect the charger to the wall outlet and turn on the power. The POWER lamp lights red.

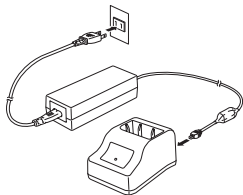

2. Align the battery pack with its metal contacts facing front, and slide it forward into the charger. *The CHARGE lamp lights red when charging starts. It turns off when the battery pack is fully charged.*

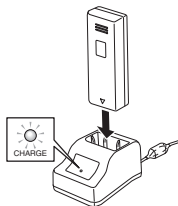

3. After charging, remove the battery pack from the charger by sliding it out.

### Notes:

- If the POWER lamp does not light when you turn on the power, check the power cord connection.

## Setup

- If the CHARGE lamp does not light at the start of charging, make sure the battery pack is firmly mounted into the charger. Poor mounting of the battery pack may result in faulty charging.
- When the fully charged battery pack is placed into the battery charger, the CHARGE lamp turns on and then off.
- When charging a battery pack that has not been used for a long time, the CHARGE lamp may blink for a while. This does not indicate an error. You can continue charging.
- The battery pack can be recharged over about 300 times (when used at normal temperatures). If the battery pack is fully charged but runs out quickly, replace it with a new battery.

## Charging Time

It takes about 1.5 hours for a fully discharged battery pack to return to a fully charged state.

## Charging the battery pack with the printer

If your printer comes with the optional AC adapter, the printer can be used to charge the supplied battery pack. Follow the steps below:

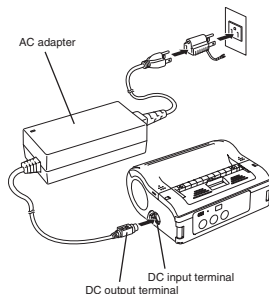

1. Remove the cover of the printer's DC input jack and connect the AC adapter's DC output terminal to it.
2. Connect the AC adapter to the wall outlet and turn on the power. The POWER lamp on the adapter lights green. Charging starts and the battery indicator on the printer lights red. When the battery pack is fully charged, the battery indicator goes off.

In the case of the MB400i/410i Wireless LAN interface model, the Battery Strength segments (See page 3-7) on the LCD screen will appear when charging starts, and go off when charging is complete.

## Charging Time

With the AC adapter, it takes about 5 hours for the battery pack to reach full charge from a fully discharged state.

## Setup

### Using the battery pack

Turn the printer off before removing or replacing the battery.

#### Insertion

1. Unlatch the battery compartment cover.
2. Align the battery pack so that its metal terminals are facing forward. Insert the battery pack while pressing and holding the gray hook. Close the battery cover.

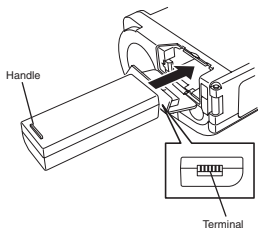
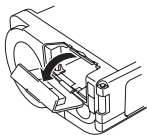

#### Removal

Push aside the gray hook in the compartment. The battery pack is released upwards. To pull out the battery pack, make use of the tape that is attached to the top part of the battery pack.

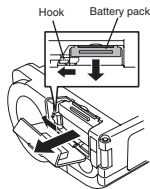

## Using the battery pack (cont'd)

### Notes

Remove the battery pack only when the STATUS LED is OFF. When the printer is turned off, the STATUS LED goes off. Do not remove the battery while the STATUS LED is on. Otherwise, the information stored in the printer may not be updated.

### Using the shoulder belt

This belt allows you to carry the printer on your shoulder.



#### Insertion

1. Thread the shoulder belt through the belt holes on the printer, from the outside to the inside.
2. Thread the end of the shoulder belt through the buckle, and adjust the length.

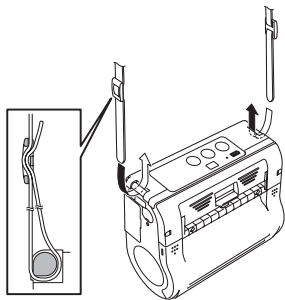

*\* If the belt is not routed correctly, the printer may drop off.*

## Setup

### Using the optional AC Adapter for power

If your printer comes with the optional AC adapter, the printer can be operated on AC power instead of the supplied battery pack. Follow the steps below:

1. Remove the cover of the printer's DC input jack and connect the AC adapter's DC output terminal to it.
2. Connect the AC adapter to the wall outlet and turn on the power. The POWER lamp turns green.

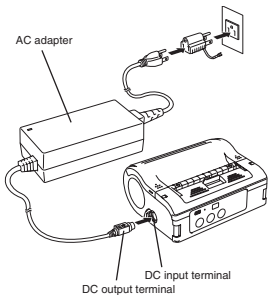

### Notes:

Be sure to turn the printer power off when removing the DC output terminal of AC adapter or disconnecting the power source. Otherwise, the information stored in the printer may not be updated. A battery pack is unnecessary when an AC adapter is used. If a battery pack and an AC adapter are being used at the same time, the printer will attempt to charge the battery pack (if it is not already fully charged).

## Loading the label roll (Continuous mode)

The method of installing label media varies with your choice of the two possible print modes—'continuous' or 'dispense' mode.

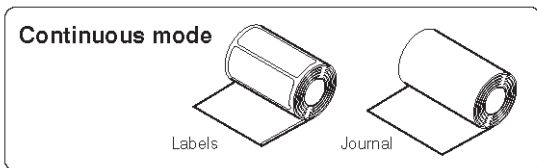

1. Make sure you can see the red platen roller. If not, slide the dispenser unit down, by lifting its top edge upwards at the two arrow marks. Now push the dark gray Cover Open/Close lever downwards to release the cover.

Dispenser unit

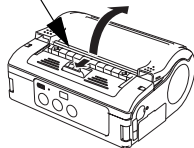

2. While pressing the label guide stopper, slide the label guide to the width of the label roll being loaded.

Label guide stopper

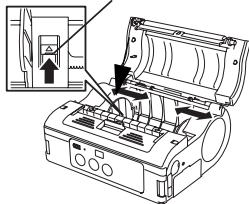

## Setup

3. Place the label roll into the printer. Make sure the label roll is placed with the first label feeding from the bottom of the roll and not from the top (see picture).

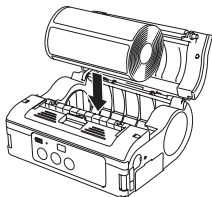

4. Turn the label roll lightly by hand and confirm that it rotates smoothly. Otherwise, paper may not be fed correctly during operation. Close the dial cover.

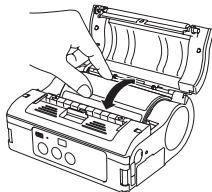

*\* When replacing a label roll of the same width as that used previously, adjustment of the label guide is not necessary.*

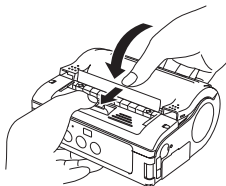

5. Close the cover after confirming that the leading edge of the label is outside the printer.

This completes the label installation for continuous mode operation.



## Loading the label roll (Dispense mode)

For operating in the Dispense mode, the following label loading procedures apply.

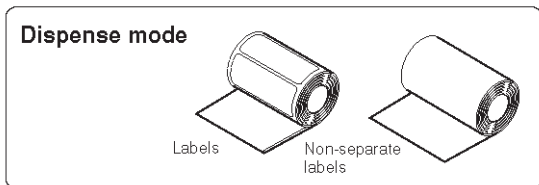

1. Make sure you can see the red platen roller. If not, slide the dispenser unit down, by lifting its top edge upwards at the two arrow marks. Now push the dark gray Cover Open/Close lever downwards to release the cover.

Dispenser unit

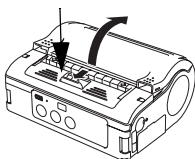

Label guide stopper

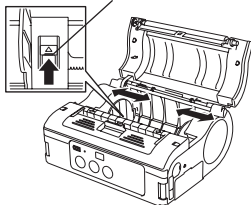

2. Peel the first label on the top of the label. *This step is unnecessary when a linerless label is used.*

## Setup

### Installing the label roll (Dispense mode)

3. Insert the label roll into the printer. Make sure the first label emerges from the bottom (not top) of the roll.

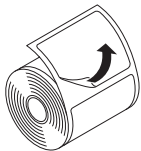

4. Adjust the label guides by hand to ensure that the label roll can be rotated smoothly. Otherwise the paper may not be fed correctly during operation.

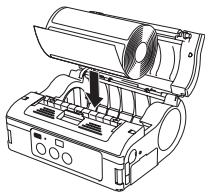

*\* When replacing a label roll of the same width as that used previously, adjustment of the label guide is not necessary.*

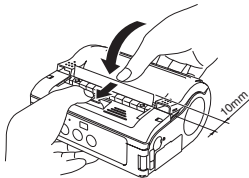
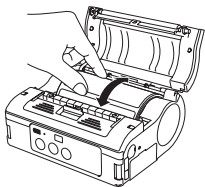

## Installing the label roll (cont'd)

3. Close the cover after confirming that the leading edge of the label is outside the printer by at least 10mm.

\* **Note:** *When using linerless labels, press the FEED button to feed a piece of label and pull the label upward to cut it along the perforation. If the label becomes jammed, retry the label setting procedure.*

4. Push the dispenser unit forward so that it covers the red platen roller.

This completes the label installation for Dispense mode operation. To resume operation in Continuous mode, lift the top edge of the dispenser unit (where two arrow marks are imprinted) to it downwards. In Continuous mode, the red platen roller will be visible.

## Setup

This page is left blank intentionally

## OPERATION AND CONFIGURATION

---

After setting up the printer and label roll in Section 2, you can now operate the printer properly.

### Turning the printer ON

Press and hold the POWER button. When the STATUS LED lights green, release the button

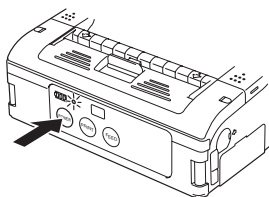

### Turning the printer OFF

Press and hold the POWER button again. When the STATUS LED goes off, release the button.

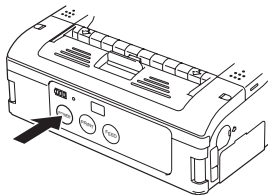

## Operation and Configuration

### Performing a Test Print

Users can perform test prints to evaluate the print quality and also diagnose problems.

1. Set the printer DIP switch for Test Print mode as shown on pages 4-2/4-3.

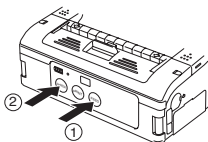

2. Press the POWER button while pressing and holding down the FEED button. The printer enters the test mode. Press the FEED button again to do a test print.

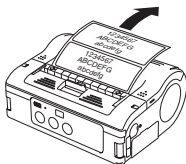

3. Verify the following using the output of the test printing.
  - All printed characters are solid black, without any chipped areas.
  - Overall print quality is readable and sharp.

*A low battery condition may affect the print quality.  
Make sure the printer is running on AC or on a full battery during a test print.*

### Notes:

If any fault is detected, contact your SATO dealer or service center. Before asking for a repair, please read the Troubleshooting section of this manual.

### Printing via the RS-232C Interface

Use the following procedure to print by connecting to a computer or a handy terminal through an RS-232C cable option.

1. Locate the RS-232C interface port cover and lift it up to expose the port.
2. Plug one end of the RS-232C cable firmly into the port. Make sure that the arrow mark on the connector of the RS- 232C cable matches with the arrow mark by the side of the printer's port.
3. Plug the other end of the RS-232C cable to the corresponding RS-232C connector of the computer or handy terminal. For information on the host device RS-232C connector, refer to the relevant instruction manual.

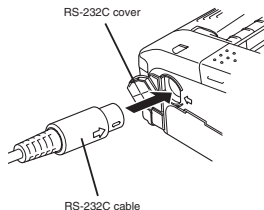

## Operation and Configuration

### Printing via the IrDA Interface

Use the following procedure to print through IrDA interface.

1. Place the printer 20 cm away from the IrDA port of the computer or handy terminal. Adjust the printer position so that the center of its IrDA filter projects a 30° conical area which contains the IrDA transceiver of the computer or handy terminal.

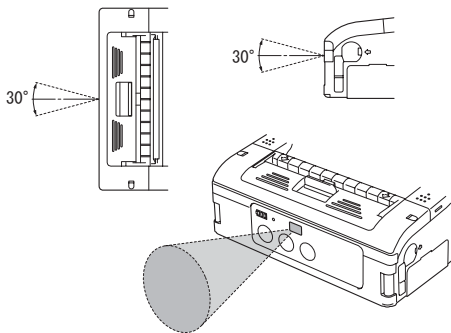

IrDA communication is limited to a 15 to 20 cm range. The usable range may vary depending on the usage environment, or the capabilities of other IrDA devices. Communication is compromised by direct sunlight or ambient light. In such a case, block the strong light from entering the IrDA filter, or reduce the distance between the two IrDA ports.



### Printing via the Wireless LAN Interface

To print using the Wireless LAN MB400i/410i, you need to have a properly configured wireless LAN set up. The next step is to configure the MB400i/410i to share the same network settings in order to establish communication.

#### 1) Check the DIP Switches:

**The printer's DIP switches are factory set for WLAN operation.** Check that Dip switch 1 is OFF and Dip switch 2 is ON. In case you need to reset other switches, refer to the full DIP-Switch table in the next chapter, **Interface Specifications**.

#### 2) Setup a connection to the Wireless Network

The next step is to ensure that your printer is configured with the proper **IP address, subnet mask, gateway, SSID, Channel, WLAN mode and security settings**. Refer to your MIS personnel for details of your existing wireless network settings. Your **SATO-certified System Integrator/dealer** can help to set up the connection to your corporate wireless network. To configure the printer yourself, consult them for the necessary software tools.

#### Note

When printing with the WLAN interface, the usable range between the printer and the host may vary depending on the usage environment and the capabilities of the connected devices.

## Operation and Configuration

### Printing via the Bluetooth Interface

To print using the Bluetooth-enabled version of MB400i/410i, you need to have a bluetooth-enabled computing device. Two more steps are required.

#### 1) Check the DIP Switches:

**The printer's DIP switches are factory set for bluetooth operation.** Check that Dip switch 1 is OFF and Dip switch 2 is ON. This is the main setting for Bluetooth operation. In case you need to reset other switches, refer to the full DIP-Switch table in the next chapter, **Interface Specifications**.

#### 2) Synchronize Bluetooth settings

After setting the DIP-switches, the next step is to ensure that both bluetooth devices are configured to operate with the same **PIN code** and **Authentication mode** settings. Refer to the instruction manual of the computing device for details on how to set these parameters.

For the MB400i/410i, these parameters can be set by a **SATO-certified System Integrator/dealer**, or by using Bluetooth communication software available from your SATO dealer or service center.

#### Note

When printing with the Bluetooth interface, the usable range between the printer and the host may vary depending on the usage environment and the capabilities of the connected devices.

### Optional LCD screen

The Wireless LAN version of the printer is factory-fitted with a Liquid Crystal Display (LCD). The screen can display the following information:

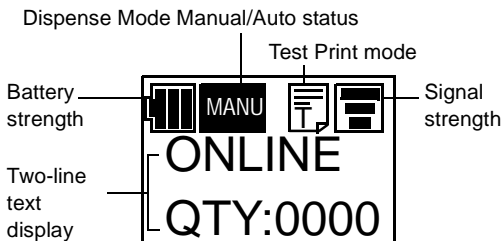

**Battery strength:** Three-segment indicator. When all segments are lit, voltage level is greater than 8.0 V. Two segments indicator a level of between 7.8 V and 7.9 V. One segment indicates a level of between 7.6 V and 7.7 V. When all segments are off (voltage level below 7.5 V, printing is not possible.)

**Signal strength:** Three-segment indicator to indicate Minimum, Medium and Maximum signal quality. An X indicates no reception.

**Test Print indicator:** Appears in Test Print mode.

### Optional LCD screen (cont'd)

**Two-line text display:** Displays the following:

- 1) **Various status messages:** Firmware version, Online mode, Offline mode, labels remaining in print queue, Test Print status, Default Setting, Complete, Factory Clear, Press Feed Key, Press Print Key, Hex Dump Mode, Set up Display, Adjust LCD, Exit, Contrast, Back Light On
- 2) **Warning messages:** Cover Open, Paper End, Sensor Error, Buffer Near Full, Head Protect, Head Error, Module Error,
- 3) **WLAN information:** Messages such as Adhoc mode, Infrastructure mode, IP address, subnet mask, default gateway, Socket Port Number.

### Adjusting Display Contrast

To adjust the contrast of the LCD, go into Maintenance mode. Use the FEED button to select options, and the PRINT button to confirm a selection.

Now select the “Adjust LCD” option and then the Contrast “option”. Values cycle between 30 and 63.

### Printing Procedure

After the proper setup and basic configuration procedures, you are ready to print to the MB400i/410i.

1. Make sure the host computer is ready to transmit data, and ensure that the STATUS LED is lit. (Press the PRINT button to take the printer ONLINE).

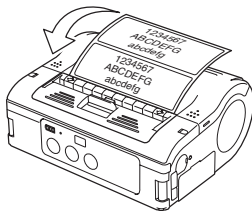

2. Start the print job from the computer. When printing is finished, pinch either the left or right corner of the printed roll of label(s) and tear it off in the direction of the arrow in the diagram.

### Notes

- The number of sheets you can print is determined by the printer's mode (continuous or peel mode).
- When printing linerless labels and you have torn the labels at a wrong place, stop the printing and follow the instructions on the next page to correct the print job.

## Operation and Configuration

### Adjusting printing for linerless labels

When printing on a continuous label roll (linerless or “non-separate”), if you tear off a label at the wrong place, proceed as follows.

1. Interrupt printing on the computer, or by pressing the PRINT key in the ONLINE state to take the printer OFFLINE. (STATUS LED goes off).

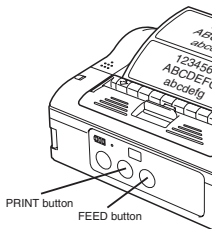

2. Press the FEED button to feed a label. When the feeding stops, tear off the label correctly by pulling the label in the direction of the arrow shown in the diagram. The label is now aligned properly for printing to resume.

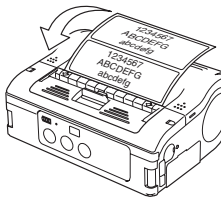

3. Press the PRINT button to return to the online state (STATUS LED lights green). You can now resume the print job.

### Choosing the Label Dispensing mode

You can choose to dispense labels in **Continuous Mode** and **Dispense Mode**. In either mode, test printing and online printing are available.

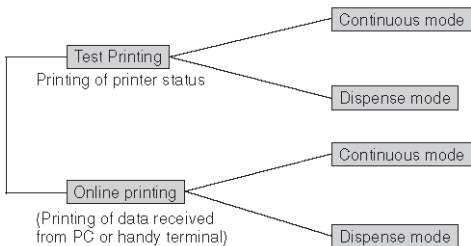

*You can select **Dispense mode** for linerless labels by using the printer setting tool.*

## Operation and Configuration

### Configuring Dispense mode

Dispense Mode can be set to Auto Print or Manual Print, as described below.

Type	Operation
Auto Print	Prints one label after receiving data and waits for peeling. After peeling a label, automatically prints next label.
Manual Print (this is the default setting)	Prints one label after receiving data and enters offline state. Pressing the PRINT key allows next label to be printed. After printing the specified number of labels, printing terminates. No printing occurs even when the PRINT key is pressed.

To switch between Auto or Manual Print for the Dispense Mode, set the DIP switches and then hold down the PRINT or FEED button when turning the printer ON. The new settings take effect when the printer is next turned ON.

**Setting Auto Print dispense mode:**

DSW1-4=OFF,OFF,OFF,ON + Cover open + Print button + power ON

**Setting Manual Print dispense mode:**

DSW1-4=OFF,OFF,OFF,ON + Cover open + FEED button + power ON

When setting the dispense mode, the STATUS LED blinks green, and turns into a steady green signal upon completion of setting. Turn off the printer **ONLY** when the STATUS LED is a steady green light.



## Other Printer Modes

Available printer modes include **Normal**, **Test Print**, **Head Check Setting** and **Online Command Setting** mode.

### Normal mode

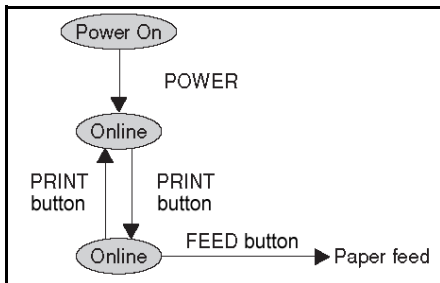

### STATUS LED behaviour in Normal Mode

Operational State	STATUS LED	LED Action
START OF PRINTING	Orange	Steady
ONLINE	Green	Steady
OFFLINE	OFF	NA
STANDBY (after 5 seconds of inactivity)	Green	Blinks every 4 seconds

Note: The Battery indicator (only available on the Bluetooth/WLAN model) remains lit even when the printer is OFFLINE. During the Standby state, the printer resumes normal operational status upon sensing any incoming data or pressing of the buttons.

## Operation and Configuration

### Printer modes (cont'd)

#### Test Print Mode

Enter Test Print mode as shown, by using the FEED and POWER buttons.

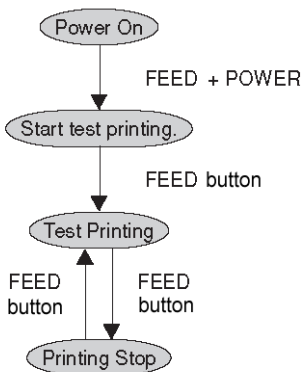

#### STATUS LED behaviour in Test Print Mode

Operational State	STATUS LED	LED Action
ENTERING TEST PRINT MODE	Orange	Steady
START OF TEST PRINT	Green	Blinks
DURING TEST PRINT	Green	Steady
END OF TEST PRINT	OFF	NA

## Printer modes (cont'd)

### Head Check Setting Mode

Head checking can be applied to one of two areas: the **normal print area** and the **barcode print area**. To specify the area subjected to a head check, follow the settings in the table below:

### Setting Head Check Area (cover must be left open)

H.Check setting	DSW-1	DSW-2	DSW-3	DSW-4	Other keys
Normal Print Area	OFF	ON	OFF	ON	hold down PRINT button
Disable H. Check	OFF	ON	OFF	ON	hold down FEED button
Barcode Print Area	ON	OFF	OFF	ON	hold down PRINT button
Disable H. Check	ON	OFF	OFF	ON	hold down FEED button

You can check the current setting with a test printout as described in “Performing a Test Print” on page 2.

When setting the Head Check options, the STATUS LED blinks green, and turns into a steady green signal upon completion of setting. Turn off the printer **ONLY** when the STATUS LED is a steady green light.

## Operation and Configuration

### Printer modes (cont'd)

#### Online Command Compatibility Mode

The printer can be set for compatibility with SBPL commands or with the older MB400-compatible commands.

#### Setting Online Command compatibility (cover must be left open)

Compatibility	DSW-1	DSW-2	DSW-3	DSW-4	Other keys
MB400-compatible online commands	ON	ON	ON	ON	hold down PRINT button
SBPL online commands	ON	ON	ON	ON	hold down FEED button

You can check the current setting with a test printout as described in “Performing a Test Print” on page 2.

When setting the online command compatibility options, the STATUS LED blinks green, and turns into a steady green signal upon completion of setting. Turn off the printer **ONLY** when the STATUS LED is a steady green light.

## Offset Configuration via Programming

The following offset adjustments for the MB400i/410i printer are usually unnecessary. Almost all adjustments are electrical in nature due to the printer's advanced self aligning and balancing design features. However, if you need to perform the adjustments, they can be sent as commands to the printer. Consult your SATO representative for information on programming the MB400i/410i printer, or refer to the Programming Reference guide found on the CD-ROM.

POSITION ADJUSTMENTS		
Adjustment	Method	Description
Printer Setting Commands	Use the <PG> programming command.	Saves the values to the Flash ROM.
Base Point Offset		
Pitch Offset		
Dispense Offset		
Tear-Off Offset		
Base Point Offset	Use the <A3> programming command.	Takes effect instantly; the value is cleared once the power is turned off.

## Operation and Configuration

POSITION ADJUSTMENTS		
Pitch Offset	Use the <PO3> programming command.	Takes effect instantly; the value is cleared once the power is turned off.
Dispense Offset	Use the <PO1> programming command.	Takes effect instantly; the value is cleared once the power is turned off.
Tear-Off Offset	Use the <PO2> programming command.	Takes effect instantly; the value is cleared once the power is turned off.

# SPECIAL SETTINGS

Through a combination of DIP switch settings and turning the printer ON with certain buttons held down, you can enable or disable special functions/features.

DIP switch				Cover	Key		Startup mode	
1	2	3	4		PRINT	FEED	Interface	Content
OFF	OFF	OFF	OFF	CLOSE	OFF	OFF	RS-232C	Normal printing mode
				CLOSE	OFF	ON	–	User test printing mode
OFF	OFF	ON	ON	CLOSE	OFF	OFF	RS-232C	HEX dump mode
				OPEN	ON	OFF	–	Buzzer sound disabled
				OPEN	OFF	ON	–	Buzzer sound enabled
OFF	OFF	OFF	ON	OPEN	ON	OFF	–	Set Automatic peeling printing
				OPEN	OFF	ON	–	Set Manual peeling printing
OFF	ON	OFF	OFF	CLOSE	OFF	OFF	Bluetooth interface Wireless LAN interface	Normal printing mode
				CLOSE	OFF	ON	–	User test printing mode
OFF	ON	OFF	ON	OPEN	ON	OFF	–	Head check (printing area) setting
				OPEN	OFF	ON	–	Head check disabled
OFF	ON	ON	ON	CLOSE	OFF	OFF	Bluetooth interface Wireless LAN interface	HEX dump mode
				OPEN	ON	OFF	–	CRC check enabled
				OPEN	OFF	ON	–	CRC check disabled
ON	OFF	OFF	OFF	CLOSE	OFF	OFF	Infrared interface	Normal startup mode
				CLOSE	OFF	ON	–	Test printing mode
ON	OFF	ON	ON	CLOSE	OFF	OFF	Infrared interface	HEX dump mode

## Special Settings

ON	OFF	OFF	ON	OPEN	ON	OFF	–	Head check (Barcode printing area) setting
				OPEN	ON	OFF	–	Head check disabled
ON	ON	OFF	OFF	CLOSE	OFF	OFF	USB interface	Normal operation
				CLOSE	OFF	ON	–	Test printing mode
ON	ON	ON	ON	CLOSE	OFF	OFF	USB interface	HEX dump mode
				OPEN	ON	OFF	–	Set compatibility with MB400 Online Commands
				OPEN	OFF	ON	–	Set compatibility with SBPL Online Commands
ON	ON	OFF	ON	OPEN	ON	OFF	–	Non-standard Control codes
				OPEN	OFF	ON	–	Standard Control codes

### Notes:

1. A small label may produce a large amount of data when printing a Hex Dump.
2. When the onboard buzzer is enabled, it will sound when the printer is turned ON during DIP switch setting. Release the FEED button to stop the buzzer.
3. To end any setting for Standard/Non-standard Control Code or Peeling Print or Online Command compatibility, confirm that the STATUS LED is lit green. Then turn the printer OFF, and reset the DIP switches as necessary.



**WARNING:** Never connect or disconnect interface cables (or use a switch box) with power applied to either the host or the printer. This may cause damage to the interface circuitry in the printer/host and is not covered by warranty.

**Note:** Some hosts monitor the Request-To-Send (RTS) signal (pin 4 of 25) to determine if the printer is ready to receive data. Since the printer does not generate this signal, the RTS line must be held true (high) in order to allow communication. Perform this by connecting the RTS pin to the Clear-To-Send (CTS) signal (pin 5 of 25).

## Special Settings

**This page is left blank intentionally**

## CLEANING AND MAINTENANCE

---

By cleaning and maintaining the printer regularly, you will prolong its durability and reliability, and also reduce the inconvenience of unnecessary malfunctions. Perform the following procedures regularly after turning the printer OFF and removing the battery pack.

### Cleaning the Print Head

Slide the Cover Open/  
Close lever downwards to  
release the cover.

If the lever cannot be  
pushed downwards, first slide  
the dispenser unit  
downwards (see the red  
arrows), so that it returns to  
the continuous mode  
position.

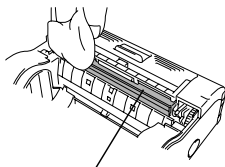
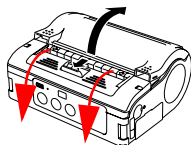

Dispenser roller

Wipe off any dirt on the print head using a cloth soaked with some alcohol.

*Never use thinner, benzene, or kerosene.*

## Cleaning and Maintenance

### Cleaning the Platen and Peel Roller

Users can perform test prints to evaluate the print quality and also diagnose problems.

Slide the Cover Open/  
Close lever downwards to  
release the cover.

If the lever cannot be  
pushed downwards, first  
slide the dispenser unit  
downwards (see the red  
arrows), so that it returns  
to the continuous mode  
position.

Wipe off any dirt using a  
cloth (soaked) in alcohol.

*Never use thinner,  
benzene, or kerosene.*

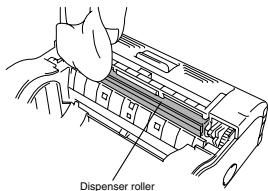
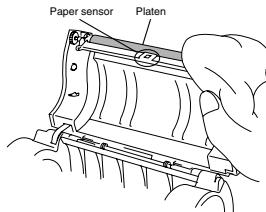
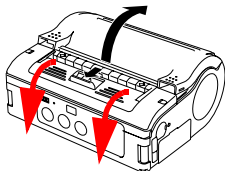

## TROUBLESHOOTING

---

When you experience any problems operating the printer, refer to the following tables.

### What to do in case of...

Print Fault	Cause	Remedy
Smudged printing	<ol style="list-style-type: none"> <li>1. Print head is dirty</li> <li>2. Roller is dirty</li> </ol>	<ol style="list-style-type: none"> <li>1. Clean the print head</li> <li>2. Clean the platen and dispense roller (See Section 5: "Cleaning and Maintenance")</li> </ol>
Vertical streaking in printouts	<ol style="list-style-type: none"> <li>1. Print head is dirty</li> <li>2. Print head is faulty</li> </ol>	<ol style="list-style-type: none"> <li>1. Clean the print head</li> <li>2. Replace the print head</li> </ol>
Slanted text characters	<ol style="list-style-type: none"> <li>1. Paper guide is positioned incorrectly</li> <li>2. Roller is dirty</li> </ol>	<ol style="list-style-type: none"> <li>1. Retry with different label paper. Use only SATO-certified media for best print quality and minimal problems</li> <li>2. Clean the platen and peel roller (See Section 5: "Cleaning and Maintenance")</li> </ol>
No printing	<ol style="list-style-type: none"> <li>1. RS-232C cable connection is faulty</li> <li>2. IrDA Interface is faulty</li> <li>3. Bluetooth/WLAN interface is faulty</li> <li>4. Dip Switch setting is incorrect</li> <li>5. Print head is faulty</li> </ol>	<ol style="list-style-type: none"> <li>1. Check the connection of the RS-232C cable connector (See "Printing via the RS-232C Interface" on page 3)</li> <li>2. The printer and IrDA host must be within 15 or 20m of each other. The host must be located within a from the center of the IrDA filter (com area) of the printer. (See "Printing via the IrDA Interface" on page 4)</li> <li>3. Check the communication protocol settings</li> <li>4. Double-check Dip Switch settings (See Section 4: "Interface Specifications")</li> <li>5. Replace the print head.</li> </ol>

# Troubleshooting Error Indicators

STATUS (LED)	Mode	Description	Cause	Remedy
Light (Red)	All modes	Low battery	Battery charge level is low.	Recharge the battery
Blink (Red) every 2s	Online	Error in Bluetooth or WLAN card	Interface module error (Bluetooth, wireless LAN)	Contact a SATO service center
Light (Red)	After Power On	1 Program illegal error 2 Flashrom-error	Flash ROM read/write error has occurred	1 Replace Flash ROM* 2 Retry downloading program*
Blink (Green-Red) every 2s	Online	Head error	Head wiring is disconnected	Replace the head*
Blink (Red) every 0.5s	Online	Cover open Paper End Sensor error	1 Cover is not locked 2 Cover-open/close sensor malfunctioning 1 Paper is not present 1 Wrong sensor level 2 Wrong sensor type 3 Paper skew	1 Lock the cover 2 Adjust sensor level*  1 Load paper 1 Adjust sensor level* 2 Set correct sensor type 3 Reload paper
Blink (Green) at 0.5s intervals	Online (Printing or receiving data)	Buffer near-full	Insufficient space in Receive Buffer area	Stop sending data from the host and wait till the buffer becomes empty. Resume sending data.
Blink (Green) every 4s	All modes	Sleep mode	Not in error. Low power consumption mode is active	Clear this mode by receiving data, pressing a key, opening or closing the cover.
Blink (Green->off->Red->off) every 1s	All modes	Head over-heat protection feature	When print head is hotter than 70°C the print head overheat protection feature is activated. Not in error.	Cleared when the head temperature drops to 50°C

*\* Contact your nearest dealer or SATO representative for support*

**WARNING:** NEVER CONNECT OR DISCONNECT INTERFACE CABLES (OR USE A SWITCH BOX) WITH POWER APPLIED TO EITHER THE PRINTER OR THE HOST. THIS MAY CAUSE DAMAGE TO THE INTERFACE CIRCUITRY AND THE DAMAGE IS NOT COVERED BY WARRANTY.

# Troubleshooting

## LCD Error Messages (WLAN model only)

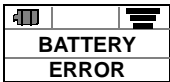
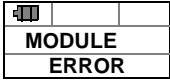
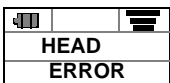
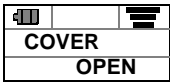
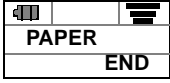
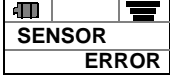
STATUS (LED)	Description	Remedy
Illegal Program Error/ Flash ROM Error	No display on the LCD	Check Status LED for detail
Low Battery	 <b>BATTERY ERROR</b>	Battery Error (Font 14x24 Dot) • Shows low battery and battery icon blinks. (*2)
Module Error Wireless LAN Bluetooth	 <b>MODULE ERROR</b>	Module Error (Font 14x24 Dot) • Shows module error was detected in Wireless LAN or Bluetooth interface. (*1)(*2)
Head Error	 <b>HEAD ERROR</b>	Head Error (Font 14x24 Dot) • Malfunction in the Print head. (*2)
Cover Open	 <b>COVER OPEN</b>	Cover Open error • Shows top cover is open. • Close the cover to return to previous display.
Paper End	 <b>PAPER END</b>	Paper End error (Font 14x24 Dot) • Label paper supply has run out • Load a new roll of label paper (*2)
Sensor Error	 <b>SENSOR ERROR</b>	Sensor Error (Font 14x24 Dot) • Sensor malfunction or error. (*2)

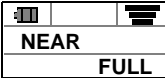
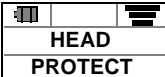

## LCD Error Messages (WLAN model only)

Buffer Near Full	 <p>The LCD display shows two progress bars at the top. The left bar is approximately 75% full, and the right bar is approximately 90% full. Below the bars, the word 'NEAR' is displayed in the top row, and 'FULL' is displayed in the bottom row.</p>	<p>Near Full error (Font 14x24 Dot)</p> <ul style="list-style-type: none"> <li>• The buffer memory is nearly full.</li> <li>• Cancel the status to return to previous display.</li> </ul>
Head Protect	 <p>The LCD display shows two progress bars at the top. The left bar is approximately 75% full, and the right bar is approximately 90% full. Below the bars, the word 'HEAD' is displayed in the top row, and 'PROTECT' is displayed in the bottom row.</p>	<p>Head Protect error (due to overheat) (Font 14x24 Dot)</p> <ul style="list-style-type: none"> <li>• The print head has overheated</li> <li>• Returns to normal status if print head cools down</li> </ul>

### Notes

- \*1) Electric field strength for wireless LAN is not displayed.
- \*2) Electric field strength for wireless LAN is displayed only when wireless LAN is set as interface.

## Troubleshooting

**This page is left blank intentionally**

## 7

# BASIC SPECIFICATIONS & OPTIONAL ACCESSORIES

## Basic Specifications

Attribute	Description
<b>Printing system</b>	Direct Thermal printing system
<b>Head density</b> MB400i: MB410i:	8 dots/mm (203 dpi) 12 dots/mm (305 dpi)
<b>Maximum print area</b>	104 mm (width) x 297 mm (pitch)
<b>Print speed</b>	103 mm/s max in normal mode 75 mm/s in dispenser mode (overall speed is reduced in dual color printing and high resolution modes)
<b>Dimensions</b>	170 mm (width) x 134 mm (height) x 76 mm (depth) (excluding convex surfaces)
<b>Weight</b>	750g with battery pack (average)
<b>Power supply (Battery)</b>	Standard battery: 1700mAh Battery pack (lithium ion 14.8V) <i>Continuously prints 4 rolls of thermal labels on a full charge. (equivalent of 50 m, print duty of 16%)</i>

## Basic Specifications & Optional Accessories

<b>Paper thickness</b>	0.064 ~ 0.190 mm (Ultra sensitive Thermal C, Techno Thermal A, Synthetic Thermal C, Dual Color Thermal) 0.064 mm (Non-adhesive Thermal media)
<b>Shape of paper</b>	Roll paper: Wound with surface out Maximum diameter: 67 mm
<b>Media Types supported</b>	<ul style="list-style-type: none"> <li>• Roll labels (face-out wound) Max. Outer diameter: 67 mm <math>\pm</math>0.5 Core diameter: 0.75", 1"</li> <li>• Coreless labels</li> <li>• Coreless Linerless labels</li> </ul>
<b>Label size</b>	(brackets indicate with liner sheet)
<b>Standard width/pitch</b>	50 to 111 mm (53 to 114 mm) 25 to 297 mm (28 to 300 mm)
<b>Dispenser width/pitch</b>	50 to 111 mm (53 to 114 mm) 25 to 182 mm (28 to 185 mm)
<b>Linerless</b>	53 to 107 mm (width) 28 to 182 mm (pitch)
<b>Label printing modes</b>	Continuous printing Dispenser printing Journal printing Linerless printing
<b>Self-diagnosis</b>	Head check/Cover open/Paper end/Battery check/Test print

## Basic Specifications & Optional Accessories

<b>Power saving features</b>	<p>Auto power off after non operation for 5 minutes. With Bluetooth or wireless LAN specifications, default is no auto power off. Auto power off time can be changed via the printer operation register command &lt;PG&gt;.</p> <p>For details of the command, refer to the Programming Guide.</p>
<b>Interfaces</b> <ul style="list-style-type: none"> <li>• <b>RS-232C</b></li> <li>• <b>USB</b></li> <li>• <b>Optical coupling</b></li> <li>• <b>Bluetooth</b></li> <li>• <b>Wireless LAN</b></li> </ul>	<p>Mini DIN (specified)</p> <p>Mini B type</p> <p>Infrared communication (compliant with IrDA Standard Ver 1.2)</p> <p>Bluetooth Specification Ver1.1 Class2</p> <p>Wireless LAN interface (IEEE 802.11b/g)</p> <p>TCP/IP (FTP, LPR, SOCKET)</p>
<b>Paper sensors</b>	<p>Reflection type (eye mark), Transmission type (gap)</p>
<b>Text Character magnification</b>	<p>1 to 6 times</p>
<b>Character rotation</b>	<p>0°, 90°, 180°, 270°</p>

## Basic Specifications & Optional Accessories

<p><b>Font types</b></p> <p>SBPL 4.0</p> <p>Compatibility Mode</p>	<p>XU, XS, XM, XB, XL, OCR-A, OCR-B, POP character Kanji: 16 x 16, 22 x 22, 24 x 24 Square Gothic (JIS Level 1, Level 2),</p> <p>XS, XM, XB, PO</p>
<p><b>Barcode</b> (POSTNET not supported in compatibility mode)</p>	<p>JAN8/13, UPC-E/UPC-A, NW-7, CODE39, CODE93, CODE128, INTERLEAVED2of5, POSTNET, RSS-14. However, barcodes shall be used with the following. Parallel barcode: Thin bar width of 2 dots or more Serial barcode: Thin bar width of 3 dots or more</p>
<p><b>Two-dimensional code</b></p>	<ul style="list-style-type: none"> <li>• PDF417 (ver 2.4) Micro-PDF supported in SBPL v4.0)</li> <li>• QR code (ver 8.1 incl. micro QR) Datamatrix code (ECC200) ver 2.0 MAXI code ver 3.0</li> <li>• UPC-A/E, JAN/EAN/UCC/EAN-128.</li> <li>• RSS-14 is compatible with CC-A/B/C)</li> </ul>
<p><b>Switches</b></p>	<p>POWER, PRINT, FEED buttons; DIP switches</p>

## Basic Specifications & Optional Accessories

<b>Indicators</b>	STATUS LED: One (Lights in three colors: Green, Red and Orange) Battery LED: Three Built-in buzzer for audible alerts Backlit 112 x 72 dot LCD screen on WLAN model
<b>Application standards</b>	FCC 15 ClassB, EN55022, EN55024, UL60950-1, CSA C22.2 No.60950-1-03, GB9243, GB9254, GB4943, GB17625.1, TUV EN60950-1, CE, R&TTE EN30328 v1.4, EN301489 v1.4, IDATSSSS.
<b>Protective features</b>	Overcharge/discharge protection Print Head overheat protection Non operable in Low Battery state
<b>Water resistance</b>	Optional shoulder bag with raintight cover (IPX3 JIS C0920-2003)
<b>Surface treatment</b>	Antibacterial finishing for external cover and operative parts. Complies with JIS Z 2801
<b>Environmental Specifications (including battery pack)*</b>  <i>*Does not apply to label media</i>	<b>Operating ambient temperature:</b> -15 to 50°C, except WLAN model which operates from 0 to 50°C <b>Humidity:</b> 20 to 80% without condensation <b>Storage ambient temperature:</b> -25 to 60°C <b>Humidity:</b> 20 to 80% without condensation

## Basic Specifications & Optional Accessories

<b>Safety Compliance</b>	FCC15B, EN55022, EN55024, EN61000-3-2, EN61000-3-3, GB4943, GB9254, GB17625.1
<b>Physical Robustness</b>	Withstands drops from 1.5m height (Breakage and damage to the case acceptable) Vibration tolerance: withstands bump testing (scrapes on the cover acceptable)
<b>RoHS Compliance</b>	< 0.1 % of Hexavalent chromium compounds, lead and its compounds, mercury and its compounds, polybrominated biphenyl (PBB) and polybrominated diphenyl ether (PBDE) compounds  < 0.01 % Cadmium and its compounds
<b>Standard Package</b>	Battery pack, Quick Guide, shoulder strap
<b>Standard Package (Starter Kit)</b>	Battery pack, AC adapter, shoulder belt, Quick Guide



## Basic Specifications & Optional Accessories

<b>Options</b>	<ul style="list-style-type: none"><li>• Battery pack</li><li>• Spare battery</li><li>• AC adapter</li><li>• Battery charger (Single-socket)</li><li>• Shoulder bag with raintight cover</li><li>• Belt bag</li><li>• Optional IrOBEX (Infrared communication protocol) feature is factory installed and cannot be retrofitted</li></ul>
----------------	---

### Notes:

1. Before using a wireless interface with this equipment, make sure that any radio transmission/reception equipment onsite, do not share the same frequency range as this product's wireless setup.
2. If any harmful radio interference should occur due to operation of RF equipment that share the same transmission/reception characteristics, contact your nearest dealer or service center to take appropriate measure to prevent interference (e.g., installing partitions).

## Basic Specifications & Optional Accessories

### MB400i/410i Radio Frequency characteristics

<b>2.4FH1</b>	<b>Freq band used</b>	2.4 GHz
	<b>Modulation system</b>	Frequency Hopped - Spread Spectrum system
	<b>Assumed distance of interference</b>	10 mm max.
	<b>Availability of frequency change</b>	All area is used and exclusion of the band for equipment for mobile object identification is impossible

## Basic Specifications & Optional Accessories

### Optional Accessories

The MB400i/410i direct thermal printer is supported by many accessories to increase its flexibility.

#### Power Items

Spare battery pack—having a spare pack reduces interruption during extended periods of printer operation.

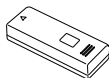

AC Adapter—allows the printer to be operated via an AC outlet, and to charge a battery pack loaded inside the printer.

(Warning: use only the specified AC Adapter designed for your printer)

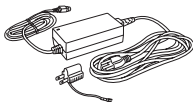

Single-slot Battery Charger—use this to charge a battery pack without using the printer connected to an AC outlet.

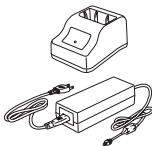

## Basic Specifications & Optional Accessories

### Optional Accessories (cont'd)

#### Portability enhancements

Rainproof Shoulder Case — allows users to attach or detach the printer and carry it around easily.



*Installation: Pinch the Rainproof case with the belt clip of the printer. If the Rainproof case is not pinched with the belt clip correctly, the printer may fall off.*

#### Connectivity options

RS-232C cable—allows connection of the printer to a PC or handy terminal.

#### Factory-installed options

Wireless LAN Interface (with LCD)—allows printing via a WLAN network. The interface comes with an LCD on the front panel to display the status of wireless communication.

Bluetooth Interface—allows printing via a Bluetooth connection.

For more details about the optional accessories, consult your authorized SATO representative.

## Basic Specifications & Optional Accessories

**This page is left blank intentionally**

