



DCS & Labelling Worldwide

M10e Printer



Operation Manual

SATO Group of Companies <u>www.satoworldwide.com</u>	
<p style="text-align: center;">SATO INTERNATIONAL PTE LTD</p> <p style="text-align: center;">438A Alexandra Road #05-01/ 02, Alexandra Technopark, Singapore 119967 Tel: 65-6271-2122 Fax: 65-6271-2151 Email: sales@sato-int.com</p>	<p style="text-align: center;">SATO EUROPE NV</p> <p style="text-align: center;">Leuvensesteenweg 369, 1932 Sint-Stevens-Woluwe, Brussels, Belgium Tel: 32 (0)-2-788-80-00 Fax: 32 (0)-2-788-80-80 Email: info@sato-europe.com</p>
<p style="text-align: center;">SATO UK LTD</p> <p style="text-align: center;">Valley Road, Harwich, Essex England Co12 4RR, United Kingdom Tel: 44-1255-240000 Fax: 44-1255-240111 Email: enquiries@satouk.com</p>	<p style="text-align: center;">SATO DEUTSCHLAND GMBH</p> <p style="text-align: center;">Schaberweg 28, 61348 Bad Homburg, Germany Tel: 49 (0)-6-1726-8180 Fax: 49 (0)-6-1726-818-199 Email: info@sato-deutschland.de</p>
<p style="text-align: center;">SATO POLSKA SP Z O.O.</p> <p style="text-align: center;">Ul Okolna 2, 50-422 Wrocław Poland Tel: 48-71-335-23-20 Fax: 48-71-335-23-25 Email: biuro@sato-polska.com.pl</p>	<p style="text-align: center;">SATO FRANCE S.A.</p> <p style="text-align: center;">Parc d'activités - rue Jacques Messager 59175 TEMPLEMARS, France Tel: +33 (0)3 20 62 96 40 Fax: +33 (0)3 20 62 96 55 Email: france@sato-europe.com</p>
<p style="text-align: center;">SATO AMERICA INC.</p> <p style="text-align: center;">10350 Nations Ford Road Suite A, Charlotte, NC 28273, USA Tel: 1-704-644-1650 Fax: 1-704-644-1662 Email: sato-sales@satoamerica.com</p>	<p style="text-align: center;">SATO ASIA PACIFIC PTE LTD</p> <p style="text-align: center;">438A Alexandra Road #05-01/02, Alexandra Technopark, Singapore 119967 Tel: 65-6271-5300 Fax: 65-6273-6011 Email: sales@satosingapore.com</p>

Warning: This equipment complies with the requirements in Part 15 of FCC rules for a Class A computing device. Operation of this equipment in a residential area may cause unacceptable interference to radio and television reception requiring the operator to take whatever steps necessary to correct the interference.

All rights reserved. This document, nor any part of it, may be reproduced or issued to third parties in any form without the express permission of SATO Europe. The material in this document is provided for general information only and is subject to change without notice. SATO Europe does not assume responsibility for any errors or omissions.

Warning

It is essential that the safety and operating procedures contained within this manual be brought to the attention of, and are used by, all personnel likely to operate this printer/product.

This printer/product must only be used for the purpose for which it was designed.

This is a Class A product. In a domestic environment this product may cause radio interference in which case the user may be required to take adequate measures.

Electrostatic discharges on the connector pins and on the memory card may damage the printer.

In the case of fire, water must not be used on the product to extinguish the fire, and the appropriate type of fire extinguisher should be readily available.

No modifications, either mechanical or electrical, should be made to this printer/product or accessory without the written consent of SATO Europe NV. Any modifications made without this consent may invalidate guarantee claims.

Other manuals relating to this printer include additional information relating to other aspects of the safe operation of the printer, and are available from your SATO supplier.

All consumable waste, such as the label backing paper and used carbon ribbon must be disposed of carefully, and in a manner that will cause the minimum of environmental pollution.

Should you have any doubts regarding the setting, operating or any safety aspects of this printer/product, please contact your SATO supplier.

SATO Europe NV makes no guarantee that all the features described in this manual are available in all models, and, due to SATO's policy of continuous development and improvement, specifications are liable to change, without notice.

Consumables

Always use SATO carbon ribbons or equivalent. The use of incorrect materials may cause malfunctions of the printer and void the warranty.

Conventions

Text that appears bold italic and all in capitals such as ***LABEL*** refers to a key or an LED on the operation panel.

Text that appears enclosed in brackets such as <ESC> refers to an Escape sequence of a data string.

Text that appears bold italic such as ***On-Line*** refers to a function or to a result.

Text that appears in bold such as **VR1** refers to electrical components like pins, resistors connectors and so on.

Warranty and Copyright

SATO Europe NV makes no guarantee of any kind with regard to this material, including, but not limited to, the implied guaranties of merchantability and fitness for a particular purpose.

SATO Europe NV shall not be liable for errors contained herein or for any incidental consequential damages in connection with the furnishing, performance, or use of this material. This document contains proprietary information which is protected by copyright.

All rights are reserved.

No part of this document may be reproduced or issued to third parties in any form whatsoever without the express permission of SATO Europe NV.

The information in this document is subject to change without notice.

© Copyright 2003 SATO Europe NV.

TABLE OF CONTENTS

Section 1. Printer Overview

Introduction	1-1
Specifications.....	1-2

Section 2. Installation

Introduction	2-1
Installation	2-1
Dimensions.....	2-2
Components.....	2-3
Media Loading	2-5
Label Sensing.....	2-8
Operation Panel	2-9
Dip Switch Panel	2-10

Section 3. CONFIGURATION

Printer Dip Switch Configuration.....	3-1
Default Settings.....	3-7
Potentiometer Adjustments.....	3-8
LCD Panel Printer Configuration	3-10

Section 4. CLEANING

Cleaning the Print Head, Platen and Rollers.....	4-1
Cleaning the Label Edge and Paper End Sensors	4-2
Cleaning the Auto Load Sensor	4-4

Section 5. Troubleshooting

Introduction	5-1
Troubleshooting Tables.....	5-1
Print Quality Problems	5-1
Error Signals.....	5-4

Section 6. Interface Specifications

Introduction	6-1
IEEE1284 Parallel Interface	6-1
RS232 Serial Interface.....	6-3
Universal Serial Bus (USB) Interface	6-5
Local Area Network (LAN) Optional Interface	6-6

Section 7. Appendix A

Appendix A.....	A-1
-----------------	-----

SECTION 1. PRINTER OVERVIEW

INTRODUCTION

The SATO M10e printer is a wide carriage thermal printer designed specifically to address need for large high resolution labels. It can print labels as large as 10.5" x 16.5" with a resolution of 305 dpi (dots per inch) at speeds up to 5 inches per second, making it ideal for large compliance label applications. All printer parameters are user programmable using the front panel controls and DIP switches. All popular bar codes and 14 human readable fonts, including vector and two raster fonts, are resident in memory providing literally thousands of type styles and sizes.

The M10e is available in two versions. The M10eDT is a direct thermal only version and must use thermally sensitive paper to print. The M10eTT is a thermal transfer model and has provisions for using a thermal transfer ribbon. It can also print in a direct thermal mode if the ribbon is not used.

This manual will help you understand the basic operations of the printer such as setup, installation, configuration, cleaning and maintenance.

The M10e uses the standard SATO Printing Language command codes. The only differences between it and other SATO printers are the allowable values representing the print positions on the label. These values are specified in "dots" and vary depending upon the resolution of the printer and the amount of memory available for imaging the label. The allowable ranges for the M10e are specified in the SATO "e" Printer Programming Reference. This commonality makes it easy to convert labels from one SATO printer without having to create an entirely different command stream. There are some caveats that must be observed though to compensate for the different resolution print heads. The effects of the different print resolutions are best illustrated by taking a label designed for a 305 dpi printer and sending the command stream to a 609 dpi printer. The label printed will be an exact one half scale, including the fonts, bar code dimensions and line length/widths. The only exceptions are the Postnet bar code and OCR-A and OCR-B fonts that have only one legal size and the printer resolution is automatically compensated for by the various printers. Conversely, a label designed for a 609 dpi printer and sent to its 305 dpi cousin will be twice as large. It probably will be "truncated" if the resulting size is larger than the maximum allowable for the printer.

GENERAL PRINTER SPECIFICATIONS

SPECIFICATION	M10e
PRINT	
Method	Direct or Thermal Transfer
Speed (User Selectable)	2 to 10 ips 50 to 125 mm/s
Print Module (Dot Size)	..0033 in. .083 mm
Resolution	309 dpi 12 d/mm
Maximum Print Width	10.5 in. 266 mm
Maximum Print Length	16.5 in. 420 mm
MEDIA	
Minimum Width	5.16 in. 131 mm
Minimum Length	1.7 in. 43 mm
Maximum Width	11.8 in. 300 mm
Type	Roll or Fan-Fold Die Cut Labels Thermally Sensitive for M10eDT
Maximum Caliper	0.008 in. 0.21 mm
Roll OD (max) Face-In	7.8 in. 200 mm
Core ID (min)	3 in 76.2 mm
SENSING	
See-Thru	Fixed, 0.9 in. (22.5 mm) left of center
Reflective Eye-Mark	Fixed, 0.2 in. (5 mm) from left label edge
Continuous Form	Not Used
RIBBON	
Widths	6.5 in. (165 mm), 8.7 in. (220 mm), 10.7 in.(273 mm)
Length (max)	984 ft. (300 m)
Thickness	4.5 micron, Wound Face-In

SPECIFICATION	M10e
CONTROLS AND INDICATORS	
Power	Green LED
On-Line	Green LED
Error	Red LED
LCD Panel	2 Line x 16 Character
Auto-Load (Rear Panel)	Green LED
Power On/Off Switch	Front Casework
On/Off-Line Key	Front Panel
Feed Switch Key	Front Panel
Cursor Control Keys	Front Panel
Enter Key	Front Panel
POTENTIOMETER ADJUSTMENTS	
Print Darkness	Top Panel
Offset	Top Panel
Pitch	Top Panel
Display	Top Panel
INTERFACE CONNECTIONS ⁽¹⁾	
Parallel	IEEE1284 Standard Centronics
Serial	RS232C (2,400 to 19,200 bps) RS232C (9600 to 57600 bps) Standard RS422/485 (9600 to 57600 bps) Optional Ready/Busy or X-On/X-Off Flow Control Bi-directional Status
Universal Serial Bus	USB Ver. 1.1 Standard
LAN	10/100BaseT
Wireless LAN	802.11b
PROCESSING	
CPU	32 Bit RISC
Flash ROM	4 MB
SDRAM	16 MB
Receive Buffer	2.95 MB
Memory Expansion	See Options and Accessories
(1) Only one interface module can be installed in a printer at a time.	

SPECIFICATION	M10e
MATRIX FONTS	
U Font	5 dots W x 9 dots H
S Font	8 dots W x 15 dots H
M Font	13 dots W x 20 dots H
XU Font	5 dots H x 9 dots H (Helvetica)
XS Font	17 dots H x 17 dots W (Univers Condensed Bold)
XM Font	24 dots H x 24 dots W (Univers Condensed Bold)
OA Font	22 dots W x 33 dots H (OCR-A)
OB Font	30 Dots W x 36 dots H (OCR-B)
AUTO SMOOTHING FONTS	
WB	18 dots W x 30 dots H
WL	28 dots H x 52 dots H
XB	48 dots H x 48 dots W (Univers Condensed Bold)
XL	48 dots W x 48 dots H (Sans Serif)
VECTOR FONT	
	Proportional or Fixed Spacing Font Size 50 x 50 dots to 999 x 999 dots Helvetica, 10 Font Variations
AGFA® RASTER FONTS	
Font A	CG Times ®, 8 pt to 72 pt
Font B	CG Trimvirate®, 8 pt to 72 pt
DOWNLOADABLE FONTS	
	Bit Mapped TrueType® Fonts with Utility Program
CHARACTER CONTROL	
	Expansion to 12X in either X or Y coordinates Character Pitch control Line Space control Journal Print facility 0°, 90°, 180° and 270° Rotation

BAR CODE	M10e
SYMBOLOLOGIES	
Linear Bar Codes	Bookland (UPC/EAN Supplemental)
	EAN-8/EAN-13
	CODABAR
	CODE 39
	CODE 93
	CODE 128
	Interleaved 2 of 5 (I 2/5)
	Industrial 2 of 5
	Matrix 2 of 5
	MSI
	POSTNET
	UCC/EAN-128
	UPC-A/UPC-E
Two Dimensional	Data Matrix
	Maxicode
	PDF417
	Micro PDF
	Truncated PDF
	QR Code
	1:2, 1:3, 2:5, User Programmable
Bar Height	4 to 999 dots, User Programmable
Rotation	0°, 90°, 180° and 270° Rotation
OTHER FEATURES	
Sequential Numbering	Sequential numbering of both numerics and bar codes
Custom Characters	RAM storage for custom designed characters
Graphics	Dot addressable, SATO Hex/Binary, BMP or PCX formats
Forms Overlay	Overlay of predesigned forms in image buffer

SPECIFICATION	M10e
PHYSICAL	
Wide	18.7 in. (475 mm)
Deep	12.3 in. (313.4 mm)
High	12.6 in.(319.2 mm)
Weight	50.7 lb. (23 kg)
POWER	
Input Voltage	Autoswitching 100-240 VAC +/-10%, 50/60 Hz
Power Consumption	560W Operating, 40W Idle
ENVIRONMENTAL	
Operating Temperature	41° to 104°F (5° to 40°C)
Storage Temperature	(-5° to 60°C)
Storage Humidity	30 to 90% RH Non-Condensing
Operating Humidity	30 to 80% RH Non-Condensing
Electrostatic Discharge	
REGULATORY APPROVALS	
Safety	UL, CSA, TUV
RFI/EMI	FCC Class B

ACCESSORIES AND OPTIONS	
PCMCIA MEMORY EXPANSION	One slot for PCMCIA Memory Card (up to 4 MB SRAM or 16 MB Flash ROM). Can be used for graphic file storage, print buffer expansion, format storage and downloaded fonts.
CALENDAR	An internal Date/Time clock that can be used to date/time stamp labels at the time of printing.
LABEL CUTTER	An attachment allowing labels to be cut at specified intervals. Controlled through programming.
COAX/TWINAX INTERFACE	Coax/Twinax Plug-In Interface module. Coax interface emulates an IBM 3287-2 printer with a standard Type A BNC connector. Twinax interface emulates IBM 5224, 5225, 5226 or 4214 printers with auto-terminate/cable through capabilities.
PARALLEL INTERFACE	IEEE1284 Bi-Directional Plug-In Interface Module
SERIAL INTERFACE	High Speed RS232 Plug-In Interface Module
USB INTERFACE	Universal Serial Bus Plug-In Interface Module
LAN	10/100 BaseT Plug-In Interface Module
WIRELESS LAN	802.11b

All specifications subject to change without notice.

SECTION 2. INSTALLATION

INTRODUCTION

This section of the manual has been written to help you install the SATO M10e printers and to get started as quickly as possible. It is recommend to read each chapter in this manual before the installation or the use of the print modules.

INSTALLATION

Remove the M10e from its packing container. The Top Cover is shipped unattached in a separate compartment. Check to mae sure you have the following accessory items:

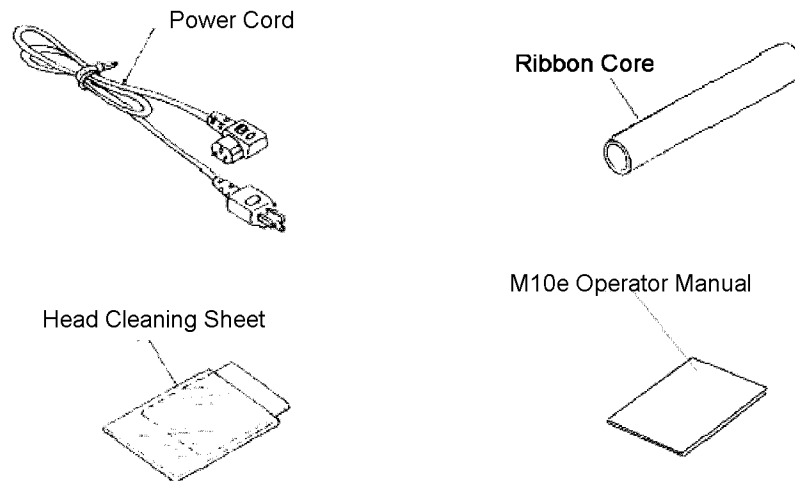

Careful consideration must be given when selecting the location of the printer, especially to environmental considerations. To obtain optimum results from the M10e, always try to avoid operation locations influenced by:

- Direct or bright sunlight, as this will make the label sensor less responsive and may cause the label to be sensed incorrectly.
- Locations which have extremes of temperature, as this can create electrical problems on the circuits within the printer.
- The installed location of the printer should ideally be in areas free from dust, humidity and sudden vibrations.

CONSUMABLES

Always use SATO carbon ribbons or equivalent in the thermal transfer models. The use of incorrect materials may cause malfunctions of the printer and void the warranty.

DIMENSIONS

Width:	18.7 inches	475 mm
Depth:	12.3 inches	313.4 mm
Height:, M10eTT:	12.6 inches	319.2 mm
Height, M10eDT	10.8 inches	274.2 mm

COMPONENTS

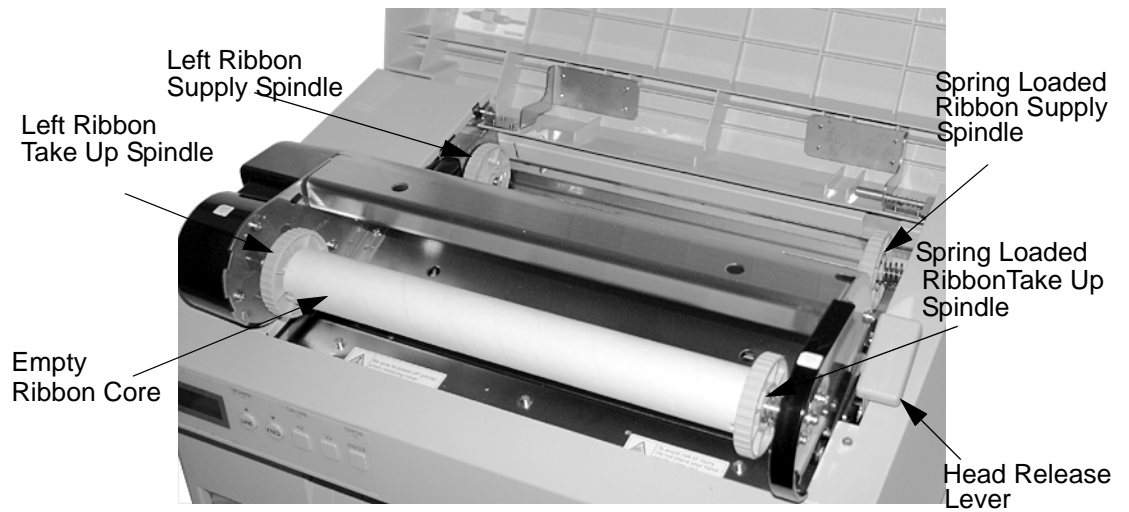
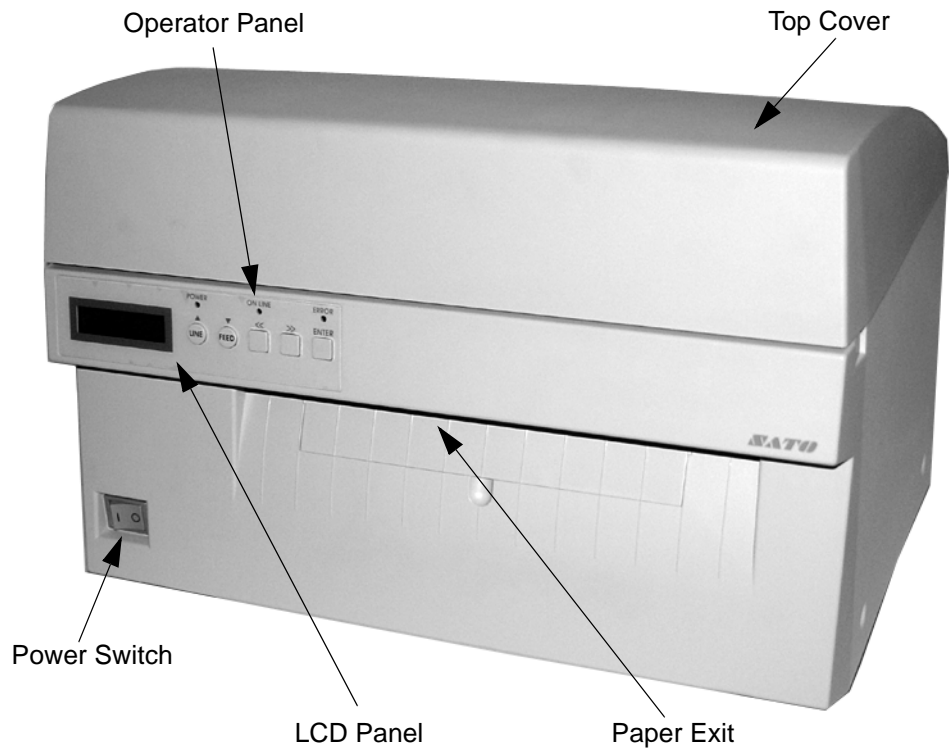

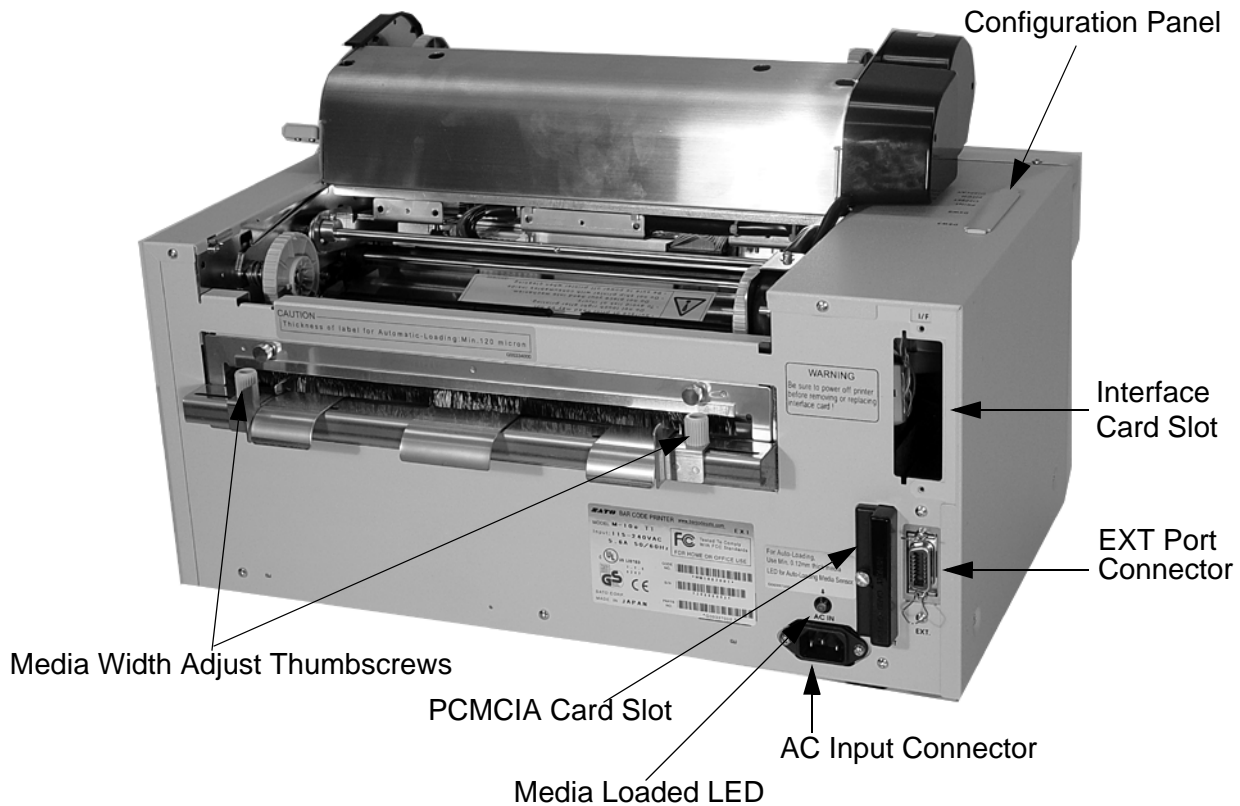

PowerSwitch	To turn power On or Off
Operator Panel	To set up the various configurations and to display dispensing quantity and the various alarms.
Configuration Panel	Potentiometers and DIP switches to configure the printer and make setup adjustments.
AC Input Connector	To input 115V/240V 50/60Hz Use the power cable provided.
Interface Slot	Slot for installation of Plug-In Interface Module.
EXT Connector	This is an external signal connector external control of print cycle.
PCMCIA Card Slot	Connector for Optional PCMCIA Memory Card.

MEDIA LOADING

Ribbon Loading (not applicable for the M10eDT)

1. Open the Top Cover to expose the ribbon mechanism..
2. Open the Print Head by pulling forward on the purple Head Latch lever on the right hand side of the ribbon mechanism.
3. Lift the Print Head by rotating it upward and to the rear.
4. The right hand Ribbon Supply Spindle is spring loaded. Press outward on the spring loaded spindle and place the new ribbon on the left hand spindle, making sure the notches in the core line up with the tangs on the spindle.
5. Place the ribbon on the right hand ribbon Supply Spindle, again making sure the notches in the core line up with the tangs on the spindle. Release the spring loaded spindle.
6. Route the ribbon around the Print Head and up to the take up core as shown in the ribbon loading diagram in the Top Cover.
7. Place an empty ribbon core on the Ribbon Take Up Spindle. The right hand spindle is spring loaded. Press outward to provide clearance to install the core. The ribbon leader is attached to the ribbon by an adhesive strip. Carefully pull the leader free and pull about 18 inches of leader from the new ribbon. The ribbon should come off the top of the roll, ink side (dull side) down.

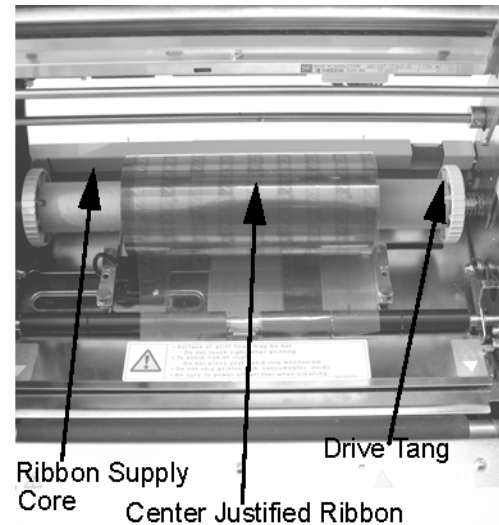
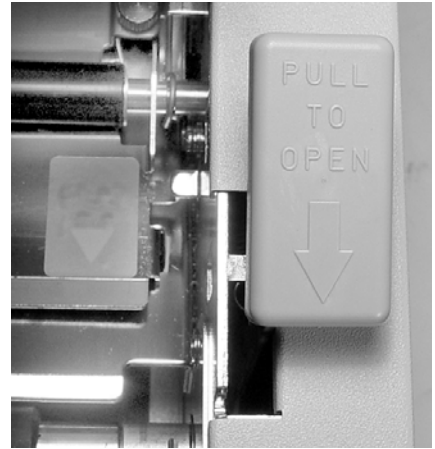

8. Route the ribbon as shown in the Ribbon Routing Diagram on the inside of the Top Cover.
9. Attach the leader to the take up core by pressing the adhesive strip on the leader firmly onto the core (if the adhesive strip does not adhere, use a small piece of tape).
10. Manually wind approximately three turns of ribbon on the core.
11. Inspect the ribbon to make sure it is not folded over or excessively wrinkled as it passes over the print head.
12. Close the Print Head by rotating it forward and down. Press firmly on each end of the ribbon mechanism at the points labeled "PUSH" until the Print Head latches firmly in place.

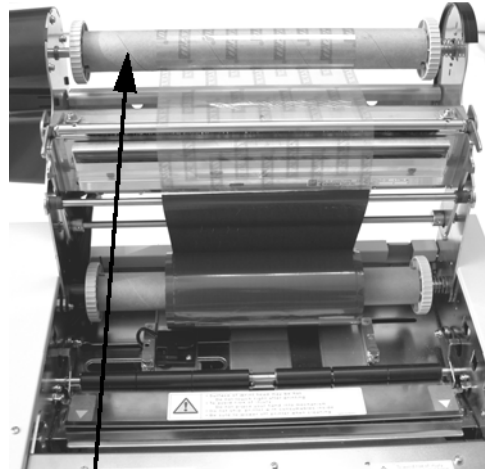

Ribbon Take Up Core

Loading the Label Stock

The M10e has an automatic media loading feature, making it extremely easy to load.

1. Select the proper media sensing method using the DIP switches on the Configuration Panel. The printer comes from the factory set up for label gap detection (DS2-2 and DS3-3 both in the Off position). If Eye-Mark labels are to be used, DS2-2 should be placed in the On position.
2. Apply power to the printer.
3. Release the Print Head by pulling forward on the Head Latch Lever.
4. Check to make sure that nothing is in the media path. Remove any media that may have been left in the printer.
5. Adjust the Label Width Guides by loosening the thumbscrew and moving the guides in or out to match the media width. The guides are interlocked so that adjusting one will automatically adjust the other side to maintain a center justified label path. Tighten the thumbscrews.
6. Note that the Green Media Loaded LED on the back panel is off.



Label Width Adjustment Thumbscrews

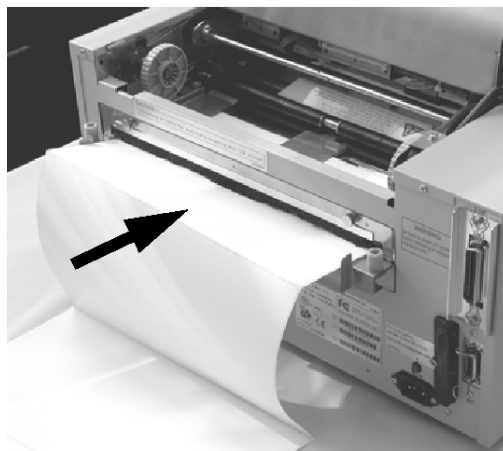

7. Thread the media into the back of the printer between the label guides. When it is correctly positioned, the Green Media Loaded LED will be on.
8. Close the Top Cover.
9. Place the printer Online by pressing the LINE key.
10. The printer will automatically feed the media into the printer until it is correctly positioned for printing.



Media Loaded LED

LABEL SENSING

The M10e can position labels using either a label gap (transmissive) or an Eye-Mark (reflective) sensor. The sensor used is selected by DSW2-2. The sensor position are fixed and cannot be adjusted. In addition, the signals from the sensors can be adjusted using the LCD panel to compensate for different liner opacities and/or Eye-Mark reflectance values.

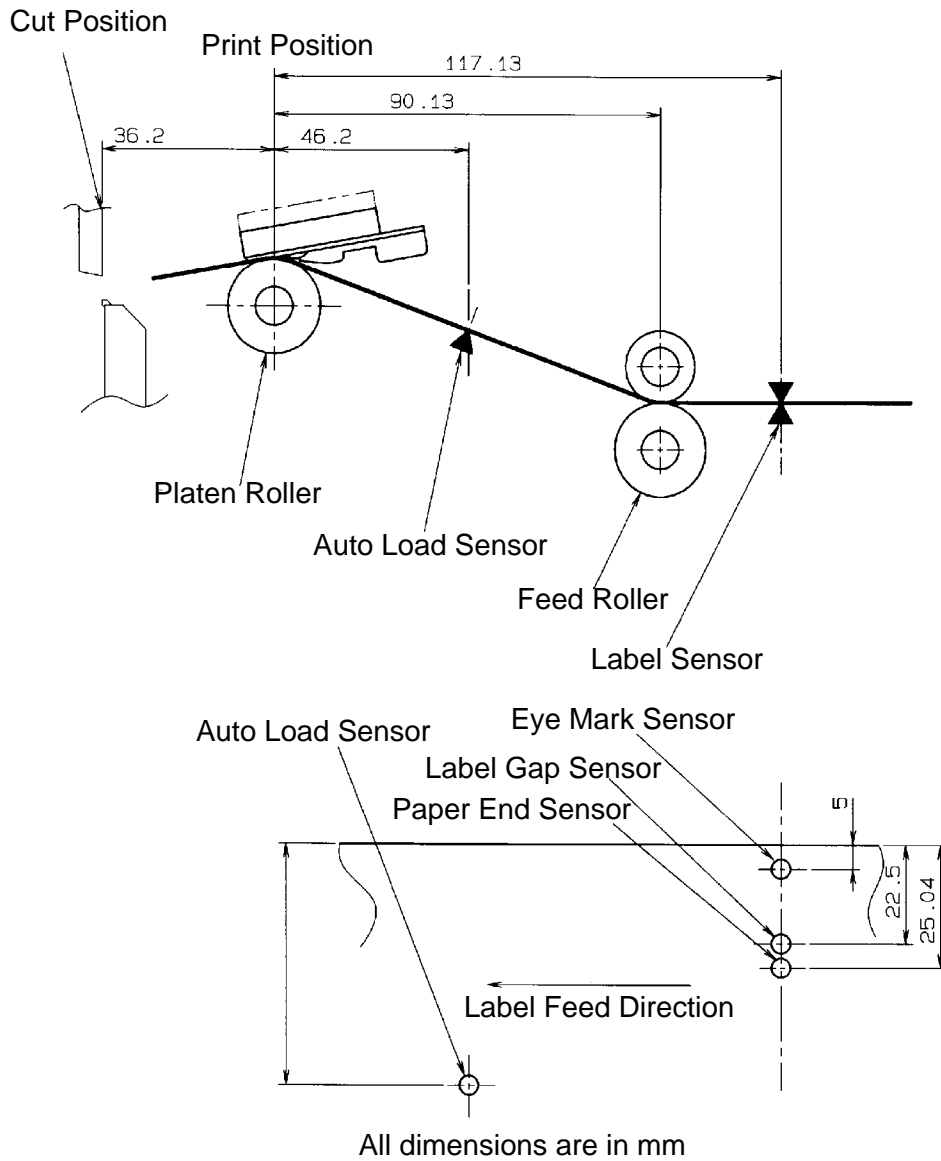

OPERATION PANEL

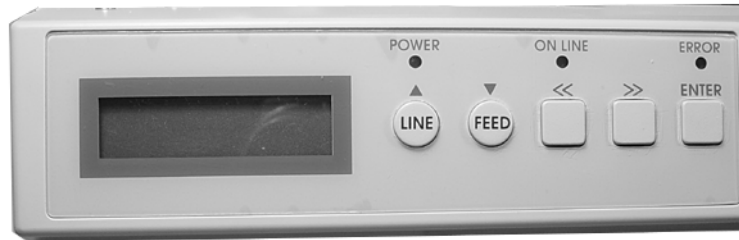

LCD Display	2 Line x 16 Character display.
POWER LED	Illuminated when power is applied.
ERROR LEDs	Illuminated when errors have occurred.
ON-LINE LED	Illuminated when printer is On-Line.
LINE Key	Switches the printer On-Line or Off-Line. It can also be used as a Pause function key to stop label during the printing process. Also used as an UP cursor control.
FEED Key	To feed one blank label. When On-Line the printer will print another copy of the last label. Also used as a DOWN cursor control.
RIGHT CURSOR >>	To move the cursor to the right.
LEFT CURSOR <<	To move the cursor to the left
ENTER	Selects setting

DIP SWITCH PANEL

The DIP Switch panel is located inside the cover and contains two 8-position DIP switches and three adjustment potentiometers. Adjustment procedures for these are listed in Section 3: Configuration.

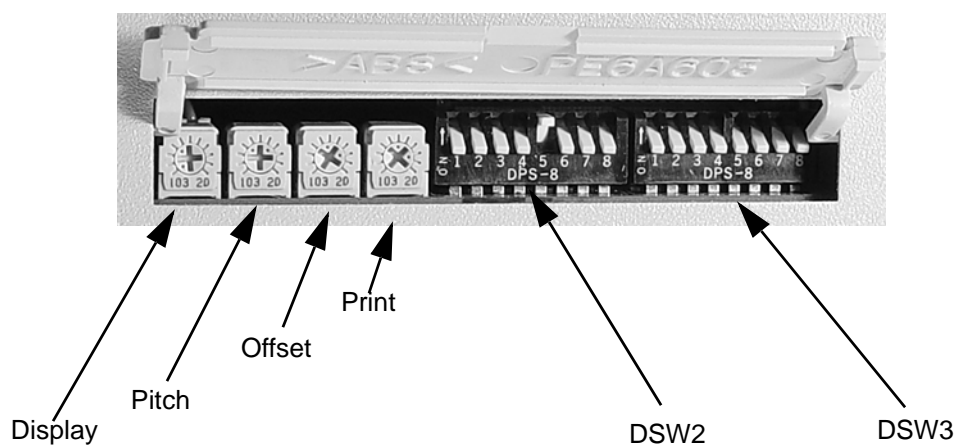

SECTION 3. CONFIGURATION

PRINTER DIP SWITCH CONFIGURATION

DIP SWITCH PANELS

There are two DIP switches (DSW2 and DSW3) located on the leftside of the printer under a flip-up cover. Raise the Top Cover for access to these switches. In addition, a third DIP switch is located on the RS232C Serial Adapter card and is used to set the RS232C transmit/receive parameters. These switches can be used to set:

- Thermal transfer or direct thermal mode
- Label sensor enable/disable
- Head check mode
- Hex dump mode
- Single Job or Multi-Job Receive buffer
- Operation mode

Each switch is an eight section toggle switch. The ON position is always to the left. To set the switches, first power the unit Off, then position the DIP switches. Finally, after placing the switches in the desired positions, power the printer back on. The switch settings are read by the printer electronics during the power up sequence. They will not become effective until the power is cycled.

RS232 TRANSMIT/RECEIVE SETTING

Data Bit Selection (DSW1-1). . This switch sets the printer to receive either 7 or 8 bit data bits for each byte transmitted.

DSW1-1	SETTING
Off	8 Data Bits
On	7 Data Bits

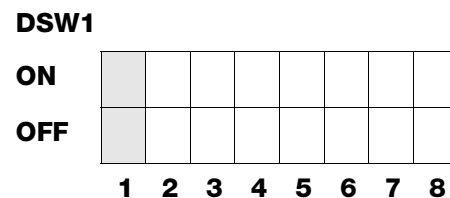

Parity Selection (DSW1-2, DSW1-3). These switches select the type of parity used for error detection.

DSW1-1	DSW1-3	SETTING
Off	Off	No Parity
Off	On	Even
On	Off	Odd
On	On	Not Used

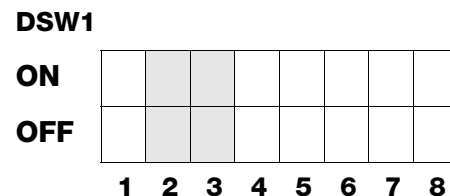

Stop Bit Selection (DSW1-4). Selects the number of stop bits to end each byte transmission.

DSW1-4	SETTING
Off	1 Stop Bit
On	2 Stop Bits

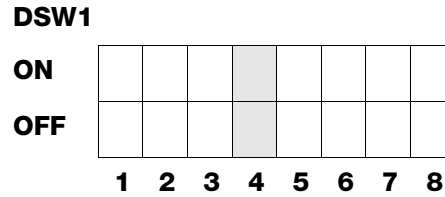

Baud Rate Selection (DSW1-5, DSW1-6). Selects the data rate (bps) for the RS232 port.

DSW1-5	DSW1-6	SETTING
Off	Off	9600
Off	On	19200
On	Off	38400
On	On	57600

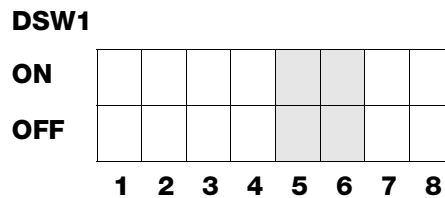

Protocol Selection (DSW1-7, DSW1-8). . Selects the flow control and status reporting protocols. See *Section 6: Interface Specifications* for more information. (* Will select the Status 2 protocol if DSW2-8 is ON).

DSW1-7	DSW1-8	SETTING
Off	Off	Rdy/Bsy
Off	On	Xon/Xoff
On	Off	Bi-Com 3
On	On	Bi-Com 4

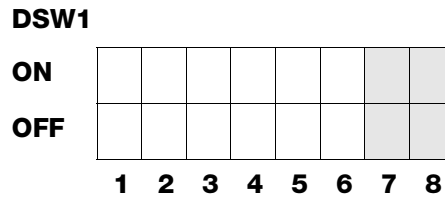

PRINTER SET UP

Print Mode Selection (DSW2-1). . Selects between direct thermal printing on thermally sensitive paper and thermal transfer printing using a ribbon.

DSW2-1	SETTING
Off	Therm Xfr
On	Direct Therm

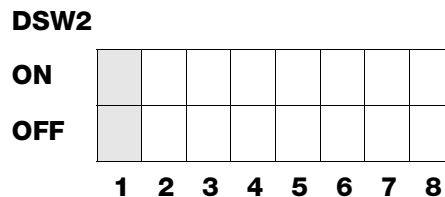

Sensor Type Selection (DSW2-2). Selects between the use of a label gap or a reflective Eye-Mark detector.

DSW2-2	SETTING
Off	Gap
On	Eye-Mark

DSW2

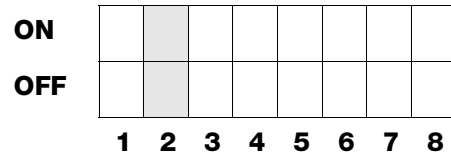

Head Check Selection (DSW2-3). . When selected, the printer will check for head elements that are electrically malfunctioning.

DSW2-3	SETTING
Off	Disabled
On	Enabled

DSW2

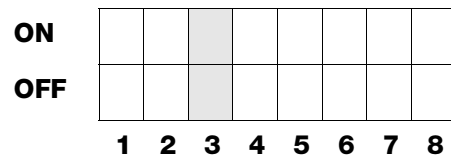

Hex Dump Selection (DSW2-4). Selects Hex Dump mode (see page 3-21).

DSW2-4	SETTING
Off	Disabled
On	Enabled

DSW2

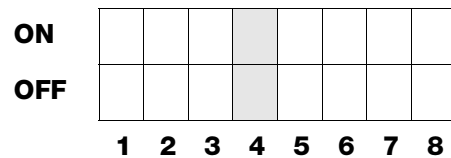

Receive Buffer Selection(DSW2-5). . Selects the operating mode of the receive buffer. See *Section 6.Interface Specifications* for more information.

DSW2-5	SETTING
Off	Single Job
On	Multi Job

DSW2

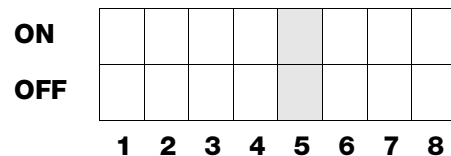

If a 10/100BaseT LAN card is installed, DS2-5 has the following definitions:

DSW2-5	SETTING
Off	ENQ Response
On	Periodic Response

Firmware Download (DSW2-6). Places the printer in the Firmware Download mode for downloading new firmware into flash ROM.

DSW2-6	SETTING
Off	Disabled
On	Enabled

DSW2

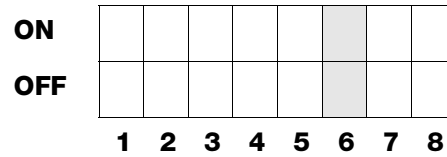

Protocol Code Selection (DSW2-7). Selects the command codes used for protocol control. Refer to page E-1 for more information.

DSW2-7	SETTING
Off	Standard
On	Non-Std

DSW2

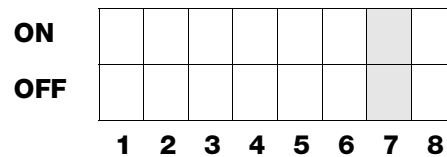

Status Select(DSW2-8). . For emulating earlier series software commands. Should be used only if problems are encountered when using existing software. This switch will also affect the settings selected by DSW1-7 and DSW1-8.

DSW2-8	SETTING
Off	Status 3 & 4 Enabled
On	Status 2 & 3 Enabled

DSW2

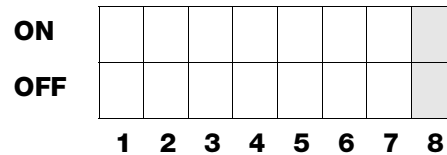

Backfeed Sequence (DSW3-1, DSW3-2). Backfeed is used to correctly position the label for application and then retract the next label to the proper print position. This operation can be performed immediately after a label is printed and used, or immediately prior to the printing of the next label.

DSW3-1		SETTING
Off	Off	Continuous
Off	On	Tear-Off
On	Off	Cutter*
On	On	Not Used

DSW3

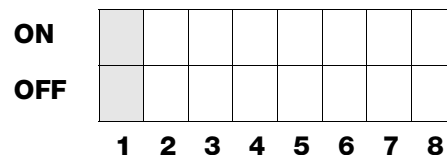

* Defaults to Continuous if cutter not installed

Label Sensor Selection (DSW3-3). . Enables or disables the Label Sensor. If the Sensor is enabled, it will detect the edge of the label and position it automatically. If it is disabled, the positioning must be under software control using Line Feed commands.

DSW3-3	SETTING
Off	Not Used
On	Sensor Used

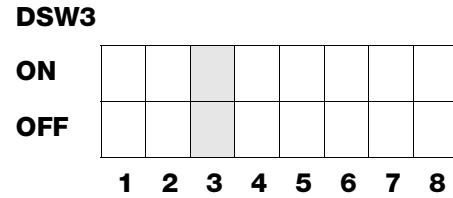

Back-Feed Selection (DSW3-4). When Back-Feed is enabled, the printer will position the last printed label for dispensing and retract it before printing the next label. The amount of backfeed offset is adjustable.

DSW3-4	SETTING
Off	Disabled
On	Enabled

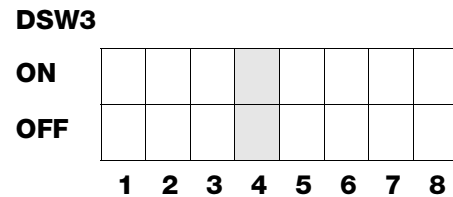

External Signal Interface. . See *Section 6: Interface Specifications* for information on the External Signals.

EXT Print Start Signal Selection (DSW3-5). Allows an external device to initiate a label print for synchronization with the applicator. When DSW3-5 is On, the unit is in the Continuous print mode, Backfeed is disabled and External Signals are ignored.

DSW3-5	SETTING
Off	Enabled
On	Disabled

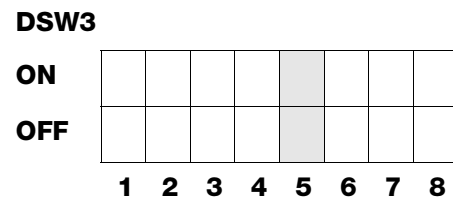

External Signal Type Selection (DSW3-6, DSW3-7). Both the polarity and signal type (level or pulse) of the external print synchronizing signal can be selected.

DSW3-6	DSW3-7	SETTING
Off	Off	Type 4
Off	On	Type 3
On	Off	Type 2
On	On	Type 1

DSW1

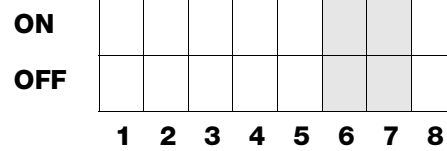

Repeat Print via External Signal (DSW3-8). . Allows the applicator to reprint the current label in the print buffer.

DSW3-8	SETTING
Off	Enabled
On	Disabled

DSW3

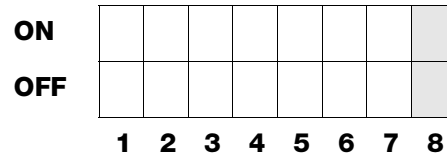

DEFAULT SETTINGS

SWITCH SELECTIONS

All switches are placed in the Off default position for shipping. This will result in the following operating configuration:

- Communications: 8 data bits, no parity, 1 Stop bit, 9600 Baud
- Protocol: Ready/Busy
- Sensor: Gap Sensor
- Receive Buffer: Multi Job
- Mode: Batch/continuous
- Label Sensor: Sensor Used
- Backfeed: Enabled
- External Signals: Enabled

SOFTWARE DEFAULT SETTINGS

The printer stores the software settings upon receipt and uses them until they are again changed by receipt of a command containing a new setting. These settings are stored in non-volatile memory and are not affected by powering the printer off. The printer may be reset to use the default software settings by depressing the LINE and FEED keys simultaneously while powering the printer on. This will result in the following default configuration:

	M10e
Print Darkness	3
Print Speed	4 in. per sec.
Print Reference	Vertical = 0000, Horizontal = 0000
Zero	Slash
Auto On Line	Enabled
Feed on Error	Enabled
Feed Reprint	Enabled
Priority	Command

Once the default operation is completed, a DEFAULT COMPLETED message will be displayed on the LCD panel. The printer should be powered off while this message is being displayed (or after the beep is heard. This saves the default settings in the non-volatile memory where they will be automatically loaded the next time the printer is powered on.

DEFAULT COMPLETED

POTENTIOMETER ADJUSTMENTS

PITCH

After the pitch has been set with the LCD Control Panel, it is sometimes desirable to make minor adjustments. This can be done using the PITCH potentiometer on the top panel. This potentiometer is set at the factory so that it has a range of +/- 3.75 mm. The midpoint setting should have no effect on the pitch. Turning the potentiometer all the way clockwise should move the print position 3.75 mm up towards the top edge of the label. Turning it all the way counterclockwise should move the print position down 3.75 mm.

1. While depressing the FEED key on the front panel, power the printer on.
2. When you hear one beep from the printer, release the FEED key and the printer will display on the LCD panel a message asking what type of Test Label you want to print.
3. Use the Cursor keys to step to the Configuration selection and press the ENTER key to accept the selection.
4. Use the Cursor keys to select the Test Label Size. After the size is selected, press the ENTER key to accept the selection and the printer will begin to print test labels continuously.
5. Adjust the PITCH potentiometer on the front panel until the first print position is at the desired location on the label. If the potentiometer does not have enough range, then you will have to change the pitch setting using the front panel display.
6. Press the FEED key to stop the printer.
7. To exit the Test Label mode, power the printer off and then back on.

Adjusting the PITCH potentiometer will affect the stop position of the label.

BACKFEED OFFSET

When a label is printed it must be correctly positioned for dispensing and application. The Backfeed adjustment is used to position the label so that it is fully dispensed and ready for application. It may then be necessary to reposition the next label before printing. The Backfeed (repositioning of the label) operation is enabled if DSW3-4 is in the Off position. If Backfeed is enabled, placing DSW3-1 is in the Off position will cause the backfeed operation to be performed immediately before each label is printed. If DSW3-1 is in the On position, the backfeed operation is performed as soon as the dispensed label has been printed and taken from the printer.

The amount of backfeed is controlled by the OFFSET potentiometer on the DIP Switch Panel inside the cover. When turned all the way counterclockwise, the amount of backfeed is +3.75 mm, and -3.75 mm when turned all the way counterclockwise.

1. Turn the printer on.
2. Press the LINE key to place the printer in the Off Line status.
3. Press the FEED key to feed out a blank label.

4. Adjust the position using the OFFSET potentiometer on the front control panel and feed another label by depressing the FEED key. Repeat this procedure until the label is fully released from the liner.

DISPLAY

This potentiometer is used to adjust the contrast of the LCD display for optimum viewing under various lighting conditions.

PRINT

The PRINT potentiometer is used to adjust the amount of heat (i.e., power) applied to the head for printing. It provides a continuous range of adjustment. Maximum print darkness is obtained by turning the potentiometer all the way clockwise and a maximum counterclockwise setting will give the lightest print.

NOTE: The PRINT potentiometer adjustment will affect the darkness in all of the command code speed and darkness ranges.

LCD PANEL PRINTER CONFIGURATION

The LCD Panel is used by the operator in conjunction with the LINE and FEED switches to manually enter printer configuration settings. Many of these settings can also be controlled via software commands and in the case of conflict between software and control panel settings, the printer will always use the last valid setting. If you load a label job that includes software settings and then enter a new setting via the LCD panel, the manually set values will be used by the printer. If you set the values manually and then download a job with software settings, the software settings will be used.

There are seven modes of operation. To enter the desired mode, the KEY SEQUENCE combination listed in the table below must be performed. The initial LCD display message is shown for each mode.

NORMAL MODE

The printer initially powers on in the ONLINE mode. The user can access the User Settings using the following procedures.

V 05.00.03.00 INITIALIZING
ONLINE QTY:000000

Displays the firmware during the initialization.

OFFLINE 000000

The LCD will display the ONLINE status on the top line and the bottom line will contain the label quantity (QTY) status. The message will be changed to OFFLINE whenever the printer is switched offline by pressing the LINE key. As soon a print job is received, the quantity line will indicate the number of labels to be printed. As soon as the label job begins to print, the display will indicate the number of labels in the print job that remains to be printed.

PRINT DARKNESS 1 2 3 4 5

Press the LINE key once. When the display changes to OFFLINE, press the FEED and LINE keys simultaneously for more than one second. Release the keys.

The LCD now displays the Print Darkness selections. The current setting is indicated by a cursor over one of the range settings. There are 5 possible selections. The lowest setting represents the lightest print and the highest setting the darkest print.

1. Press the Cursor keys to step the cursor to the desired setting.
2. Once the correct setting is underlined, press the ENTER key to accept the selection and step the display to the next adjustment.

PRINT SPEED 3 4 5

The print speed selections are dependent upon the printer model. The current setting is indicated by the cursor.

1. Use the Cursor keys to step the cursor to the desired setting.
2. Once the correct setting is selected, press the ENTER key to accept the selection and step the display to the next adjustment.

PITCH OFFSET + 00mm

The label Pitch is the distance from the leading edge (the edge that comes out of the printer first) of a label and the leading edge of the next label. The leading edge position of the label can be adjusted relative to the print head +/- 59mm in increments of 1mm. Once the position is set, it can be fine adjusted +/- 3.75mm using the PITCH potentiometer on the Adjustment Panel.

1. The cursor will initially be positioned over the Pitch Direction setting. Use the Cursor keys to step to the positive (+) or negative (-) selection. A positive selection moves the leading edge of the label forward (away from the print head) while a negative selection moves the leading edge of the label back into the mechanism.
2. Once the correct direction is selected, pressing the ENTER key will accept the setting and advance the cursor to the Offset selection.
3. Use the Cursor keys to step the first digit of the counter to the desired setting. The display will increment one step each time the Cursor keys are pressed. The maximum setting is 5.
4. Press the ENTER key to accept the setting and advance the cursor to the second digit. Again use the Cursor keys to step to the desired setting. Once it is correct, pressing the ENTER key will step to the next adjustment.
5. You may wish to print a test label after completing the adjustments to ensure they are correct.

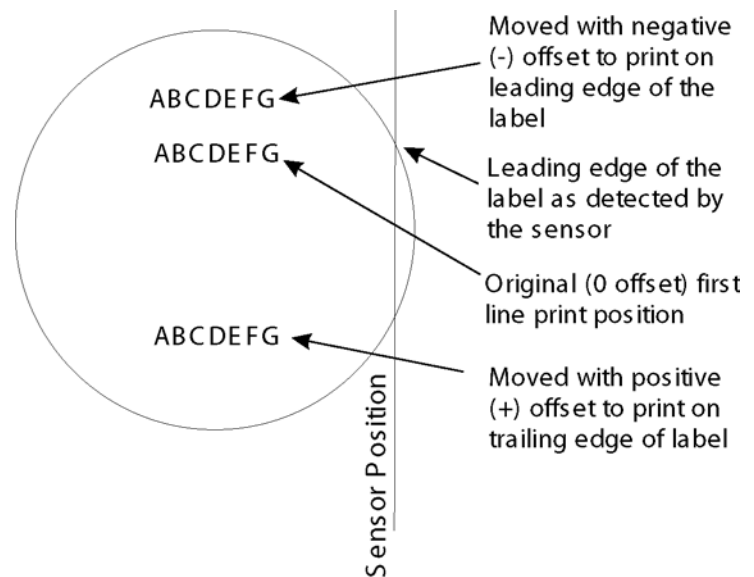

**CANCEL PRINT JOB
YES NO**

If the printer has a print job(s) in memory, selecting YES will cause the job(s) to be cleared. The default selection is NO. Be sure you want to cancel the print job(s) before selecting yes as the job(s) cannot be recovered and will have to be retransmitted to the printer.

1. Use the Cursor keys to step the cursor to either the YES or NO selection.
2. Once the correct setting is selected, pressing the ENTER key will accept the setting.

**CANCEL PRINT JOB
COMPLETED**

3. After the print job(s) have been cleared from memory, the printer will beep 3 times and display a COMPLETED message for 3 seconds and then return to the initial ONLINE Normal Mode.
4. If you wish to change any of the settings, you must enter the User Settings mode again by taking the printer OFFLINE and pressing the LINE and FEED keys.

SECTION 4. CLEANING

CLEANING THE PRINT HEAD, PLATEN AND ROLLERS

Supplies needed:**SATO SA070 Cleaning Kit****Cleaning the Print Head**

1. Turn the printer off.
2. Open the Top Cover.
3. Open the Print Head Assembly by pulling the Head Latch toward the front of the printer. The Print Head Assembly is spring-loaded and will automatically open as soon as the Head Latch is disengaged. Rotate the Print Head Assembly up and to the rear to give access to the underside of the print head.
4. Remove the ribbon (M10eTT only)
5. Apply SATO Thermal Print Head Cleaner to a cotton swab.
6. The Print Head faces downward along the front edge of the assembly. Pass the end of the dampened swab along the epoxy ridge that runs the entire width of the Print Head.
7. Check for any black colouring or adhesive on the swab after cleaning.
8. Repeat if necessary until the swab is clean after it is passed over the head.
9. The head should be cleaned at least every time the ribbon is changed and more often in dusty environments.

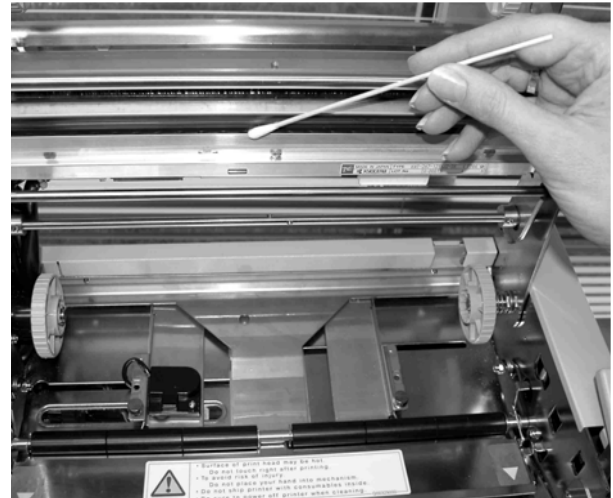

Cleaning the Platen and Rollers

1. Turn the printer off.
2. Open Top Cover.
3. Open the Print Head Assembly by pulling the Head Latch toward the front of the printer. The Print Head Assembly is spring-loaded and will automatically open as soon as the Head Latch is disengaged. Rotate the Print Head Assembly up and to the rear to give access to the Platen.
4. Lift up on both ends of the Label Cover Plate at the points marked with the purple arrows until it releases.
5. Apply SATO Thermal Print Head Cleaner to one of the cotton swabs.
6. The Platen is the rubber roller directly below the Print Head. It should be cleaned of any ribbon or label residue.
7. The Label Feed Rollers are located to the rear of the Print Head Assembly. They should be cleaned of any label residue or foreign material.
8. Repeat if necessary. The platen and rollers should be cleaned whenever foreign matter such as dust or adhesive is present.
9. Reposition the Label Cover Plate and press down at the points marked with the purple arrows until it snaps in place.

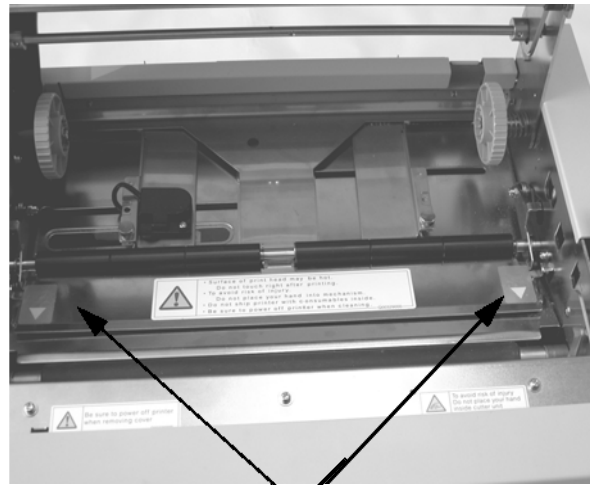

Lift Label Plate at arrows to give access to the label roller

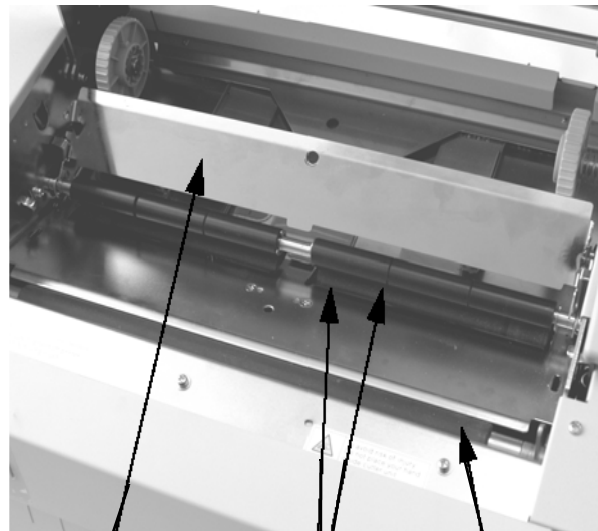

Label Cover Plate

Label Rollers

Platen

CLEANING THE LABEL EDGE AND PAPER END SENSORS

There are two sensors that are used to control the positioning of the label. One is a transmissive see-thru sensor that detects the edge of the label by looking through the backing paper which is translucent and detecting the presence of the opaque label. Another is a reflective sensor that detects the light reflected from the bottom of the label liner. When a printed black Eye-Mark passes through the beam, the light is

no longer reflected back to the sensor detector, indicating to the printer that it should use this position as the start of a new label. When dust, dirt, adhesive or other foreign matter interferes with the light path of either of these sensors, the results is erratic label positioning and feeding. These sensors should be cleaned regularly, at least every two rolls of labels. In addition, a Paper End sensor is used to detect when the media supply has been depleted. It is very important that this sensor be kept operating properly since the Print Head depends upon the presence of the media as a heat sink. Printing without media under the head can result in damage to the Print Head.

Supplies Needed:

1. Turn the printer off.
2. Open the Top Cover.
3. Unlatch the Print Head Assembly and remove any labels remaining in the printer.
4. Remove the ribbon (M10eTT only).
5. The Label Edge Senors are located in the paper path behind the Print Head. See *Section 2:Installation* for their location relative to the Print Head. They are automatically positioned when the the Label Width Guides are adjusted.
6. Remove the thumbscrew holding the Sensor Housing.
7. Apply SATO Thermal Print Head Cleaner to one of the cotton swabs.
8. Use the cotton swab to clean any foreign matter from the exposed surface of the sensors.
9. Reposition the Sensor on the adjustable paper guide and replace the thumbscrew.

SATO SA070 Cleaning Kit



Thumbscrew

Sensor Assembly

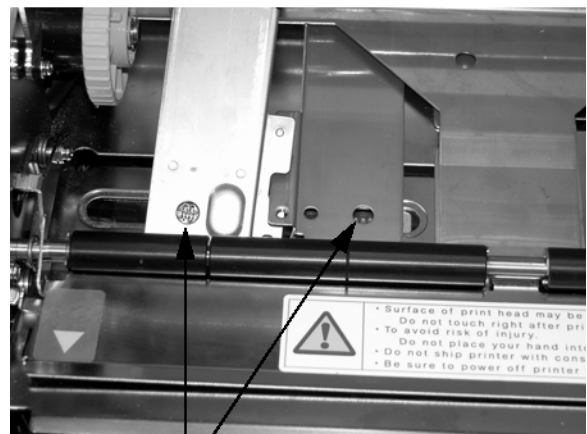

Sensors

CLEANING THE AUTO LOAD SENSOR

In addition, there is one more sensor to sense when the media is correctly positioned for auto loading. When dust, dirt, adhesive or other foreign matter interferes with the light path of this sensors, the results is erratic paper end error signals. This sensors should be cleaned regularly, at least every two rolls of labels.

Supplies Needed:**SATO SA070 Cleaning Kit**

1. Turn the printer off.
2. Open the Top Cover.
3. Release the Print Head by pulling forward on the Head Release Latch
4. Remove the ribbon (M10eTT only)
5. Apply SATO Thermal Print Head Cleaner to one of the cotton swabs.
6. The sensor is located in the Print Head Assembly.
7. Use the cotton swab to clean any foreign matter from the exposed surface of the sensors.

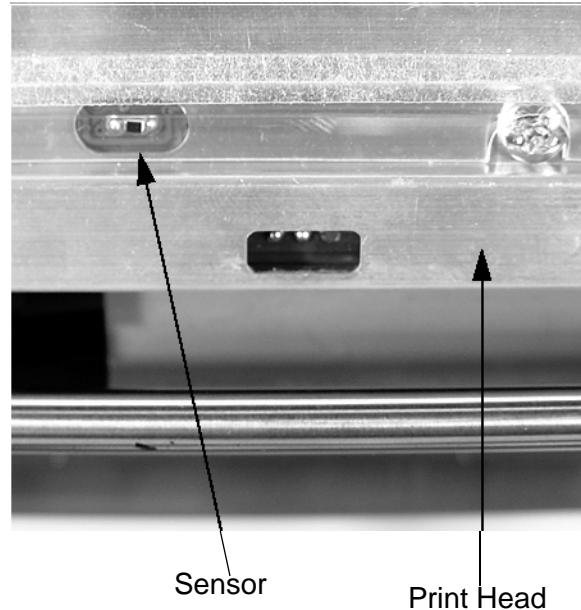

SECTION 5. TROUBLESHOOTING

INTRODUCTION

The design of the SATO CL-608e/612e printer is based upon proven technology and reliable components. When a problem occurs, the solution can be easily traced using the troubleshooting tables in this section. This table list symptoms, probable causes, and suggested corrective actions.

Both print quality and general operational problems are listed in the troubleshooting table.

TROUBLESHOOTING TABLES

The troubleshooting table below includes the following general symptom descriptions:

- Image Voids
- No Label Movement
- LABEL LED on
- Ribbon Wrinkle
- No printed Image
- RIBBON LED on
- Light Images
- Display Problem
- ON LINE LED not on
- Smearing
- POWER LED not on
- No Label Drive
- No Ribbon Movement
- ERROR LED on

- ☺ The suggested actions may be carried out by the end-user.
- ✘ The suggested actions should only be carried out by experienced service staff. Recall your reseller or service agent.

PRINT QUALITY PROBLEMS

SYMPTOM	PROBABLE CAUSE	SUGGESTED CORRECTIVE ACTION
Image Voids	Poor quality labels	Use thermal transfer compatible stock ☺
	Poor quality ribbons	Use genuine SATO ribbons ☺
	Ribbon not matched to label stock	Check with media suppliers ☺
	Damaged electronics	Replace circuit board ✘
	Damaged Platen	Replace Platen ✘
Ribbon Wrinkle	Poor Head Alignment	Adjust head balance ✘ Adjust ribbon roller ✘ Adjust head alignment ✘
	Poor Ribbon Tension	Adjust ribbon tension ✘
	Worn Platen	Replace platen ✘
	Foreign material on head or platen	Clean head and platen ☺
	Foreign materials on labels	Use high quality label stock ☺
	Damaged print head	Replace print head ✘

SYMPTOM	PROBABLE CAUSE	SUGGESTED CORRECTIVE ACTION
Light Images	Poor quality labels	Use thermal transfer compatible stock ☺
	Poor quality ribbons	Use genuine SATO ribbons ☺
	Low print head energy/darkness	Adjust darkness control ☺
	Low print head pressure	Use correct head pressure position ✖
	Ribbon not matched to label stock	Select better suited carbon Ribbon ☺
	Foreign material on head	Clean head and platen ☺
	Poor head alignment	Align Print Head ✖
	Excessive print speed	Reduce print speed setting ☺
Smearing	Poor quality labels	Select better suited carbon Ribbon ☺
	Poor quality ribbons	Use genuine SATO ribbons ☺
	Foreign material on head/platen	Clean head and platen ☺
	Foreign material on labels	Use high quality label stock ☺
	Excessive print head energy	Adjust darkness control ☺
	Excessive print speed	Adjust print speed ☺
	Excessive head pressure	Use correct head pressure position ✖
No Ribbon Movement	Incorrect ribbon core size	Use genuine SATO ribbons ☺
	Loose platen drive belt	Adjust/replace belt ✖
	No + 24 volt output	Test power supply and replace if required ✖
	Loose service screws on rewind pulley	Tighten service screws ✖
	Damaged electronics	Replace circuit board ✖
No Label Movement	Loose/broken platen drive belt	Adjust/replace belt ✖
	Incorrect label pitch sensor selected	Select correct label sensor type (DSW2-2) ☺
	No +24 volt output	Replace fuse on main PCB ✖ Test power supply and replace if required ✖
	Loose set screw on platen pulley/step-per motor	Tighten set screws ✖
No Printed Image	Print head not connected	Verify print head connector fully seated at head and PCB ✖
	Ribbon upside down	Use genuine SATO ribbons ☺
	No + 24 volt output	Test power supply and replace if required ✖

SYMPTOM	PROBABLE CAUSE	SUGGESTED CORRECTIVE ACTION
No Printed Image	Damaged print head	Replace print head ✖
	Damaged electronics	Replace circuit board ✖
Back light but no words on display or no display.	Most common failure of printer is DOA situation. The most likely cause is the ribbon cable has fallen out or not seated fully into connector.	Verify that the cable and connector are properly seated ☺
POWER LED not on	AC power cable not connected	Verify that the cable is connected to the printer and the AC outlet ☺
	Main Power Fuse defective	Replace fuse ✖
	Defective power supply	Test power supply and replace if defective ✖
ERROR LED on	Head not locked	Close and latch head release ☺
LABEL LED on	Label supply roll empty	Replenish label supply ☺
	Label stock not routed through sensor	Reload labels ☺
	Label sensor not positioned correctly	Adjust sensor position ✖
	Label sensor blocked	Clean label sensor ☺
	Incorrect label sense threshold setting	Adjust label sense threshold ✖
RIBBON LED on	Ribbon supply roll empty	Replenish ribbon supply ☺
	Ribbon sensor out of alignment	Realign ribbon sensor ✖
	Ribbon sensor blocked	Clean ribbon sensor ✖
	No cardboard core on ribbon rewind	Use cardboard core on ribbon rewind ☺
ON LINE LED not on	LABEL, RIBBON, ERROR LED (s) on	Clear error condition ☺
	Illegal printer memory state	Cycle POWER switch off and back on ☺
No Label Drive	Timing Belt bad/loose	Replace/tighten timing belts ✖

ERROR SIGNALS

The LCD Display, Front Panel LED Indicators and Buzzer provide a visual/audio indication of the type of error encountered.

LED	LCD MESSAGE	AUDIBLE BEEP	ERROR CONDITION	POSSIBLE CAUSES
Error On	Machine Error	1 Long	Machine Error	1. Defective Board ✖
Error On	EEPROM Error	1 Long	EEPROM Read/Write	1. EEPROM not installed correctly. ✖ 2. Overwriting EEPROM. ✖
Error On	Head Error	1 Long	Head	1. Electrical head malfunction ✖
Error On	Sensor Error	3 Short	Sensor	1. Paper jam. ☺ 2. Sensor DSW setting. ✖ 3. Sensor level adjustment. ✖
Error Blinks	Card R/W Error	1 Long	Memory Card Read/Write	1. Card not formatted ✖ 2. No card recognized. ✖
Error Blinks	Card Low Battery	1 Long	Memory Card Battery Low	1. Card battery needs replacement. ✖
Error Blinks	Card No Battery	1 Long	No Battery in Card	1. Card needs battery installed. ✖
Error Blinks	Head Open	3 Short	Head Open	1. Head not latched. ☺ 2. Head latch switch bad. ✖
Error Blinks	Cutter Error	3 Short	Cutter	1. Cutter jam. ☺ 1. Cutter sensor dirty. ☺
Error On Line Blinks	Parity Error	3 Short	RS232 Parity Error	1. RS232 parameter mismatch. ✖
Error On Line Blinks	Overrun Error	3 Short	RS232 Overrun Error	1. RS232 parameter mismatch ✖
Error On Line Blinks	Framing Error	3 Short	RS232 Framing Error	1. RS232 parameter mismatch ✖
Error On Line Blinks	Buffer Over	3 Short	Buffer Overflow	1. Command stream exceeds buffer size. ✖
Error Blinks	Paper End	3 Short	Media End	1. No paper. ☺ 2. Paper incorrectly loaded. ☺
Error Blinks	Ribbon End	3 Short	Ribbon End	1. Needs new ribbon roll. ☺ 2. Ribbon sensor needs adjustment. ✖
	Download Error R/W Error Mem Full Error	3 Short	Download Error	1. Read/Write error. ✖ 2. Corrupted download file. ✖ 3. Download file too large. ✖
	CopyCard/Format R/W Error No Card Error Mem Full Error	3 Short	Card Copy or Format Error	1. R/W error during copying. ✖ 2. Card not installed properly. ✖ 3. File too large. ✖

SECTION 6. INTERFACE SPECIFICATIONS

INTRODUCTION

The M10e printer utilize a Plug-In Interface Module for maximum printer configuration flexibility. This section presents the interface specifications for the M10e printer. These specifications include detailed information on how to properly interface your printer with your host system.

The following information is presented in this section:

- Using the Receive Buffer
- IEEE1284 Parallel Interface
- Universal Serial Bus (USB) Interface
- Local Area Network (LAN) Interface
- RS232C Serial Interface
- Bi-Comm Communications Protocol
- Status Response

WARNING: Never connect or disconnect interface cables (or use a switch box) with power applied to either the host or the printer. This may cause damage to the interface circuitry in the printer/host and is not covered by warranty.

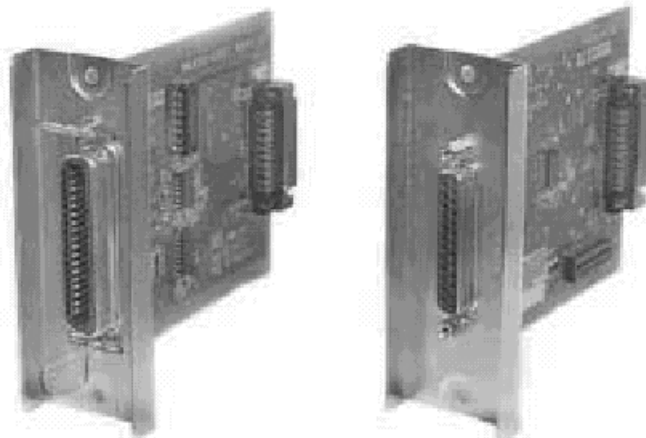

IEEE1284 PARALLEL INTERFACE

The parallel interface for the Series “e” printers is a Plug-In Interface Module that can be installed by the user. It conforms to the IEEE1284 specification. It will automatically detect the IEEE1284 signals and operate in the high speed mode. If it does not detect the IEEE1284 signals, it will operate in the standard Centronics mode, which is significantly slower. For this reason, an interface cable and host

interface conforming to the IEEE1284 specification must be present to fully utilize the speed capabilities. This interface also operates bi-directionally and can report the status of the printer back to the host.

ELECTRICAL SPECIFICATIONS

Printer Connector	AMP 57-40360 (DDK) or equivalent
Cable Connector	AMP 57-30360 (DDK) or equivalent
Cable	IEEE1284 Parallel, 10 ft. (3 m) or less
Signal Level	High = +2.4V to +5.0V Low = 0V to -0.4V

DATA STREAMS

<ESC>A . . Job#1 . . <ESC>Z<ESC>A . . Job#n . . <ESC>Z

IEEE1284 Parallel Interface Pin Assignments

PIN	SIGNAL	DIRECTION	PIN	SIGNAL	DIRECTION
1	STROBE	To Printer	19	STROBE Return	Reference
2	DATA 1	To Printer	20	DATA 1 Return	Reference
3	DATA 2	To Printer	21	DATA 2 Return	Reference
4	DATA 3	To Printer	22	DATA 3 Return	Reference
5	DATA 4	To Printer	23	DATA 4 Return	Reference
6	DATA 5	To Printer	24	DATA 5 Return	Reference
7	DATA 6	To Printer	25	DATA 6 Return	Reference
8	DATA 7	To Printer	26	DATA 7 Return	Reference
9	DATA 8	To Printer	27	DATA 8 Return	Reference
10	$\overline{\text{ACK}}$	To Host	28	ACK Return	Reference
11	BUSY	To Host	29	BUSY Return	Reference
12	PTR ERROR	To Host	30	PE Return	Reference
13	SELECT	To Host	31	$\overline{\text{INIT}}$	From Host
14	$\overline{\text{AUTOFD}}^{(1)}$	To Host	32	$\overline{\text{FAULT}}$	To Host
15	Not Used		33	Not Used	
16	Logic Gnd		34	Not Used	
17	FG	Frame Ground	35	Not Used	
18	+5V (Z=24K ohm)	To Host	36	$\overline{\text{SELECTIN}}^{(1)}$	From Host

(1) Signals required for IEEE1284 mode.

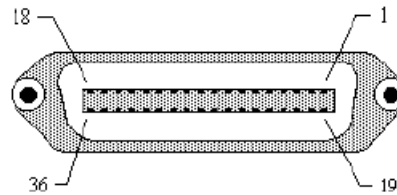

RS232 SERIAL INTERFACE

The High Speed Serial Interface is a Plug-In Interface Module that can be installed in the printer by the user.

GENERAL SPECIFICATIONS

Asynchronous ASCII

Half-duplex communication
 Ready/Busy Hardware Flow Control
 Pin 20, DTR Control
 Pin 4, RTS Error Condition
 X-On/X-Off Software Flow Control
 Bi-Directional Communication

Data Transmission Rate

9600, 19200, 38400, 57600 bps

Character Format

1 Start Bit (fixed)
 7 or 8 data bits (selectable)
 Odd, Even or No Parity (selectable)
 1 or 2 Stop bits (selectable)

ELECTRICAL SPECIFICATIONS

Connector DB-25S (Female)

Cable

DB-25P (Male), 50 ft. maximum length.
 For cable configuration, refer to Cable Requirements appropriate to the RS232C protocol chosen.

Signal Levels

High = +5V to +12V
 Low = -5V to -12V

PIN ASSIGNMENTS

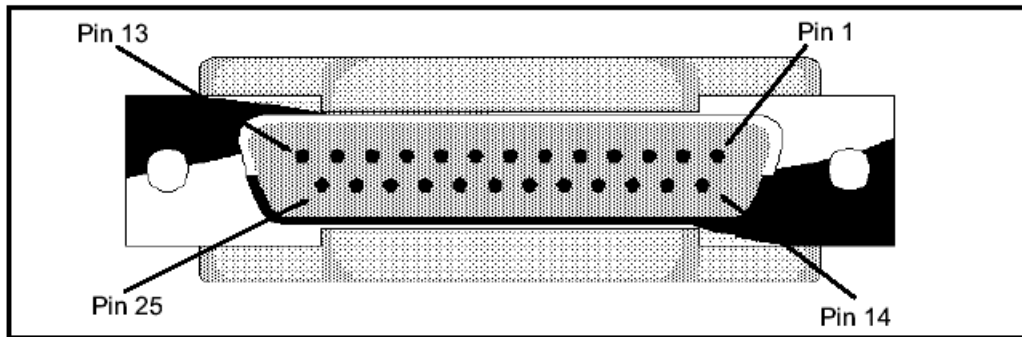

RS232C Interface Signals

PIN	DIRECTION	SIGNAL DEFINITION
1	Reference	FG (Frame Ground)
2	To Host	TD (Transmit Data) - Data from the printer to the host computer. Sends X-On/X-Off characters or status data (Bi-Directional protocols).
3	To Printer	RD (Receive Data) - Data to the printer from the host computer.
4	To Host	RTS (Request to Send) - Used with Ready/Busy flow control to indicate an error condition. RTS is high and remains high unless the print head is open (in this case, RTS would return to the high state after the print head is closed and the printer is placed back on-line) or an error condition occurs during printing (e.g., ribbon out, label out).
5	To Printer	CTS (Clear to Send) - When this line is high, the printer assumes that data is ready to be transmitted. The printer will not receive data when this line is low. If this line is not being used, it should be tied high (to pin 4).
6	To Printer	DSR (Data Set Ready) - When this line is high, the printer will be ready to receive data. This line must be high before data is transmitted. If this line is not being used, it should be tied high (to pin 20).
7	Reference	SG (Signal Ground)
20	To Host	DTR (Data Terminal Ready) - This signal applies to Ready/Busy flow control. The printer is ready to receive data when this pin is high. It goes low when the printer is off-line, either manually or due to an error condition, and while printing in the Single Job Buffer mode. It will also go low when the data in the buffer reaches the Buffer Near Full level.

CABLE REQUIREMENTS

DB9	DB25	HOST	INTERCONNECTION	DB25	PRINTER
1	1	FG	←————→	1	FG (Frame Ground)
2	3	RD	————→	2	TD (Transmit Data)
3	2	TD	←————→	3	RD (Receive Data)
8	5	CTS	————→	4	RTS (Request to Send)
7	4	RTS	————→	5	CTS (Clear to Send)
4	20	DTR	————→	6	DSR (Data Set Ready)
6	6	DSR*	←————→	20	DTR (Data Terminal Ready)
5	7	SG	←————→	7	SG (Signal Ground)

** This connection at the host side of the interface would depend upon the pin that is being used as the Ready/Busy signal by the driving software. Typically, on a PC, it would be either CTS (pin 5) or DSR (pin 6) on a DB-25 connector.*

UNIVERSAL SERIAL BUS (USB) INTERFACE

The Universal Serial Bus (USB) interface is a Plug-In Interface Module that can be installed by the user. It requires a driver (shipped with each printer that has the interface installed) that must be loaded on your PC and the PC must be configured to support USB peripherals using Windows 98 or above. Details for loading the USB driver are contained in the USB Interface Manual that is shipped with each printer with a USB Optional interface installed. Up to 127 devices may be connected to a USB port using powered hubs.

GENERAL SPECIFICATIONS

- Connector:** USB Type B Plug
- Cable:** 10 ft (3 m) max
- Host:** Windows 98 or above with USB Port

ELECTRICAL SPECIFICATIONS

- Power Supply:** BUS Power through cable
- Power Consumption:** +5V@80ma

LOCAL AREA NETWORK (LAN) OPTIONAL INTERFACE

A Local Area Network (LAN) interface is a Plug-In Interface Module that can be installed by the user. It requires a driver shipped with each printer that has the interface installed. The driver that must be loaded on your PC and the PC must be configured to run one of the supported network protocols using a 10/100BaseT LAN connection. Details for loading the LAN driver are contained in the LAN Interface Manual that is shipped with each printer with a LAN Optional interface installed.

GENERAL SPECIFICATIONS

Cable: 10/100BaseT Category 5

Connector: RJ-45 Receptical

ELECTRICAL SPECIFICATIONS

Power Supply: Powered from printer

APPENDIX A

LCD Mode Overview

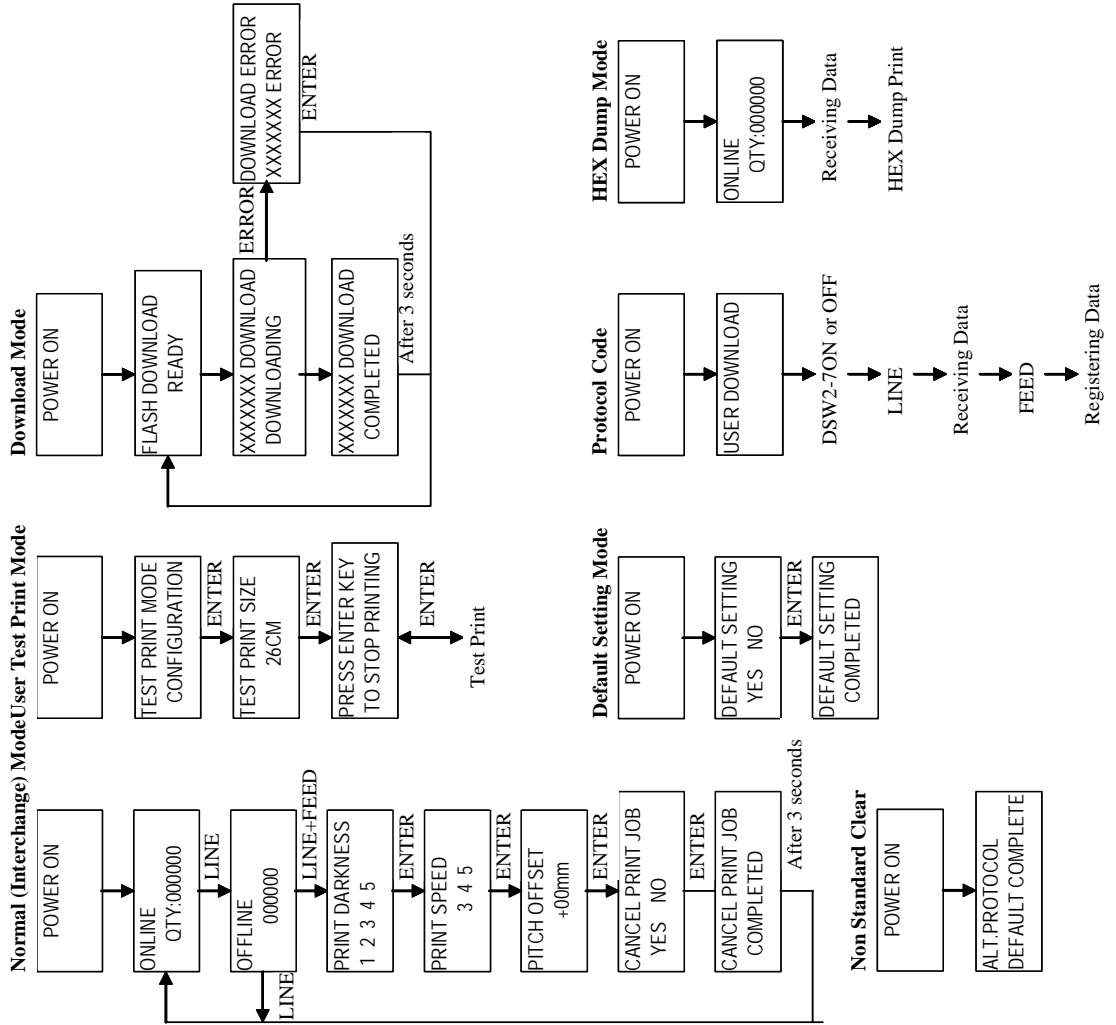
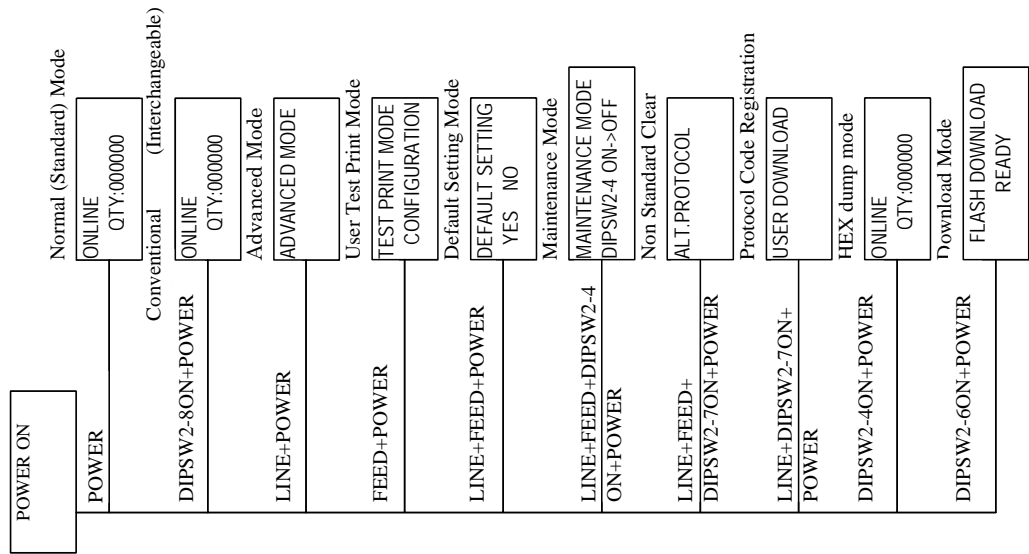

Maintenance Mode

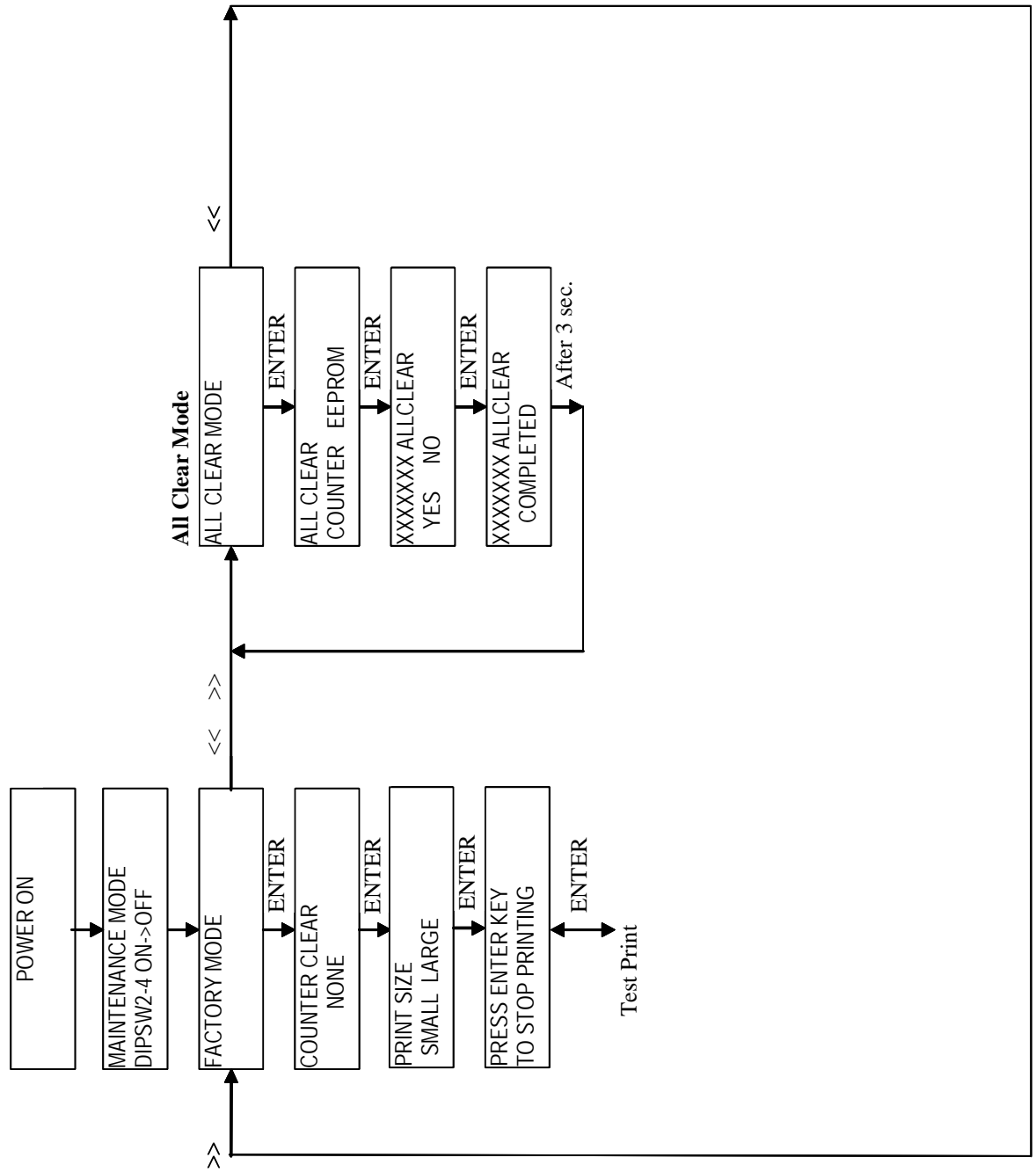

MANUFACTURERS DECLARATION OF CONFORMITY

Product identification Product: Thermal or Thermal Transfer Printer
Type: **M10e**
Options: all

Means of conformity

The product is in conformity with the **EMC Directive 89/336/EEC, 92/31/EEC and 93/68/EEC** based on test results using harmonised standards.

standards used: EN55022:1998 (Class B)
EN61000-3-2: 2000 Class A
EN61000-3-3: 1995+A1:2001

EN55024 : 1998
EN61000-4-2:1995+A1:1998+A2:2001
EN61000-4-3:1996+A1:1998+A2:2001
EN61000-4-4:1995+A1:2001
EN61000-4-5:1995+A1:2001
EN61000-4-6:1996+A1:2001
EN61000-4-8:1993+A1:2001
EN61000-4-11:1994+A1:2001

Test report number: E22IE0067-YW-1

Test carried out by: A-pex International Co.,Ltd. YOKOWA LAB.
Date: 03 June 2002

The product is in conformity with **Low Voltage Directive 73/23/EEC** based on test results using harmonised standards.

standards used: EN60950/A11 : 1997

Test carried out by: TÜV Product Service GmbH
Certificate No: AL 02 06 15569 029
Report No.: 22FS0122
Date: 11. June 2002

Manufacturer: Bar Code SATO Electronics (M) SDN. BHD.
Lot 20, Jalan 223
46100 Petaling Jaya
Selangor Darul Ehsan, Malaysia

EC Representative: SATO Europe NV Leuvensesteenweg 369
1932 Sint-Stevens-Woluwe - Brussels
Belgium

Signature: Patrick Frimat 

Function: Managing Director SATO Europe NV
Date: 01. 01. 2004