

Operator Manual

For printer model:

CL4NX
CL6NX

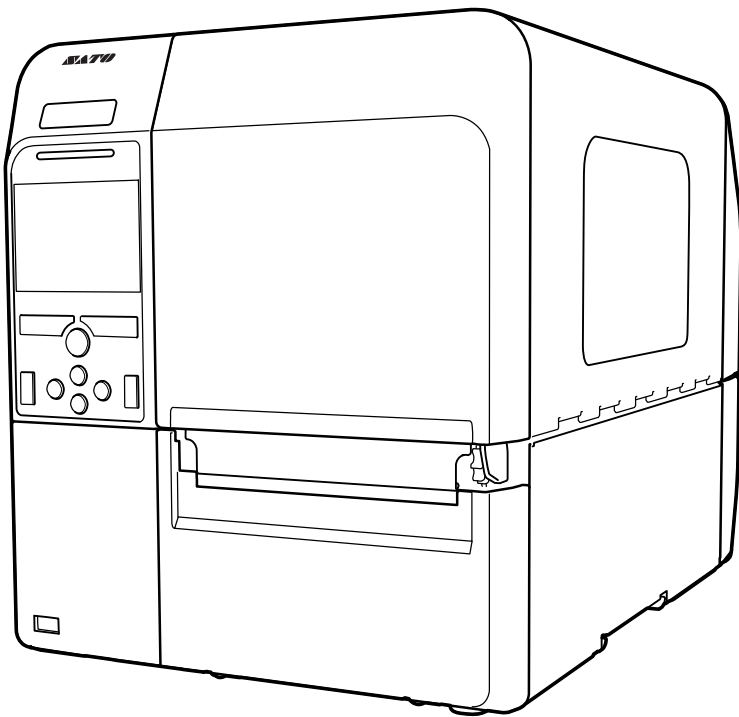

Copyrights

Any unauthorized reproduction of the contents of this document, in part or whole, is strictly prohibited.

Limitation of Liability

SATO Corporation and its subsidiaries in Japan, the U.S. and other countries make no representations or warranties of any kind regarding this material, including, but not limited to, implied warranties of merchantability and fitness for a particular purpose. SATO Corporation shall not be held responsible for errors contained herein or any omissions from this material or for any damages, whether direct, indirect, incidental or consequential, in connection with the furnishing, distribution, performance or use of this material.

Specifications and contents in this document are subject to change without notice.

Be sure to perform a virus check for the USB memory before connecting it to the printer. SATO Corporation shall not be held responsible for any printer malfunctions caused by a virus spread via USB memory.

Trademarks

SATO is a registered trademark of SATO Holdings Corporation and its subsidiaries in Japan, the U.S. and other countries.

QR Code is a registered trademark of DENSO WAVE INCORPORATED.

Wi-Fi® is a registered trademark of Wi-Fi Alliance.

Wi-Fi Direct™, Wi-Fi Protected Setup™, WPA™ and WPA2™ are trademarks of Wi-Fi Alliance.

Cisco, the Cisco logo, and Cisco Systems are trademarks or registered trademarks of Cisco Systems, Inc. and/or its affiliates in the United States and certain other countries.

Bluetooth is a trademark of Bluetooth SIG, Inc., U.S.A.

ENERGY STAR® and ENERGY STAR mark are registered U.S. marks.

ICODE, I-CODE, and SLI are registered trademarks of NXP B.V.

MIFARE® is a registered trademark of NXP B.V.

Tag-it™ is a trademark of Texas Instruments.

my-d™ is a registered trademark of Infineon Technologies AG.

FeliCa is a registered trademark of Sony Corporation.

FeliCa is a contactless IC card technology developed by Sony Corporation.

Android is a trademark of Google Inc.

All other trademarks are the property of their respective owners.

Version: GBS-CL4NX_CL6NX-r08-01-08-16OM

© 2016 SATO Corporation. All rights reserved.

Table of Contents

Table of Contents	1
Before You Start	7
Features of the Product	7
Safety Precautions	8
Precautions for Installation and Handling	11
Regulatory Approval	12
1 Parts Identification.....	15
1.1 Parts Identification of the Printer	15
1.1.1 Front View	15
1.1.2 Rear View	16
1.1.3 Internal View	17
1.2 Parts on the Operator Panel.....	18
1.2.1 Operator Panel	18
1.2.2 LED Indicator	19
2 Installing the Printer	21
2.1 Installation Precautions.....	21
2.2 Installation Space.....	22
2.2.1 Front View (CL4NX)	22
2.2.2 Front View (CL6NX)	22
2.2.3 Side View (CL4NX/CL6NX)	23
2.2.4 Bottom View (CL4NX)	24
2.2.5 Bottom View (CL6NX)	24
2.3 Checking the Bundled Accessories	25
2.4 Connecting the Interface Cable	26
2.4.1 Available Interfaces	26
2.4.2 Interface Settings.....	27
2.4.3 NFC Interface Connection	27
2.5 Connecting the Power Cord.....	28
2.6 Power On/Off the Printer	29
2.6.1 Power On the Printer	29
2.6.2 Power Off the Printer	30

2.7 Starting Up the Printer (Startup Guide)	31
2.7.1 Startup Screen.....	31
2.7.2 Language Selection.....	31
2.7.3 Region Setting with Optional RTC.....	32
2.7.4 City Setting with Optional RTC.....	32
2.7.5 Date Setting with Optional RTC.....	32
2.7.6 Time Setting with Optional RTC.....	33
2.7.7 Print Method Setting.....	33
2.7.8 Ribbon Setting.....	34
2.7.9 Setting the Media Sensor Type.....	34
2.7.10 Media Setting.....	35
2.7.11 Confirmation Screen.....	36
2.7.12 Startup Guide Cancelation.....	36
3 Loading the Ribbon and Media	37
3.1 Checking the Ink Side of the Ribbon	37
3.2 Loading the Ribbon	38
3.3 Removing the Ribbon	41
3.4 Usable Media	42
3.4.1 Adjusting the Position of the Media Sensor.....	42
3.5 Loading Media	43
3.5.1 Loading Media Roll.....	43
3.5.2 Loading Fan-fold Media.....	45
3.5.3 Loading Media with the Optional Cutter.....	46
3.5.4 Loading Media with an Optional Dispenser and Liner Discharge Outlet.....	46
3.5.5 Loading Media with an Optional Dispenser and Liner Rewinder.....	47
3.5.6 Removing the Liner from the Rewinder.....	49
4 Operation and Configuration	51
4.1 Display and Operation	51
4.1.1 Online Mode/Offline Mode.....	51
4.1.2 Status Icon.....	52
4.1.3 Error Icon.....	55
4.1.4 Guidance Video.....	58
4.1.5 Adjusting the Print Settings During Printing.....	61
4.1.6 Canceling the Print Job.....	62
4.2 Settings Mode	63
4.2.1 Changing to Settings Mode.....	63
4.2.2 Log In to/Log Out of the Settings Mode.....	64
4.2.3 Item Selection.....	65
4.2.4 Setting Value Input or Selection.....	66
4.3 Settings Menu Tree Structure	69

4.4 Details of the Settings Menu Screen	83
4.4.1 Shortcut Menu	83
4.4.2 Printing Menu	84
4.4.3 Interface Menu.....	105
4.4.4 Applications Menu	177
4.4.5 System Menu.....	205
4.4.6 Tools Menu	216
4.4.7 Information Menu.....	238
4.5 Web Configuration	248
4.5.1 Dashboard	248
4.5.2 Settings.....	249
4.5.3 Tools.....	251
4.5.4 Certificates.....	253
5 Cleaning and Performing Printer Adjustments	255
5.1 Maintenance	255
5.2 Maintenance of the Print Head and Platen Roller	256
5.2.1 Maintenance using the Cleaning Kit	256
5.2.2 Additional Procedure for the Optional Linerless Cutter Kit (CL4NX only).....	259
5.2.3 Maintenance using the Cleaning Sheet.....	260
5.3 Adjusting the Base Reference Point	262
5.3.1 About the Base Reference Point	262
5.3.2 Adjusting the Print Position.....	263
5.3.3 Adjusting the Media Stop Position.....	265
5.3.4 Notes on the Stop/Cut Position of Different Media	266
5.4 Adjusting the Print Quality	268
5.4.1 Adjusting the Print Darkness	268
5.4.2 Adjusting the Print Speed	269
5.5 Adjusting the Buzzer Volume	271
5.6 Adjusting the Head Pressure Balance	272
5.6.1 Head Pressure Setting	272
5.6.2 Pressure Balance Setting	273
6 Troubleshooting.....	275
6.1 When an Error Message Occurs	275
6.1.1 More Information about Command Error	283
6.2 When the LED Lights Red/Blue	285
6.3 Troubleshooting Table	286
6.3.1 No Power/Nothing on the Screen	286
6.3.2 Cannot Feed the Media	286
6.3.3 Can Feed the Media but Cannot Print	287
6.3.4 Bad Print Quality.....	288
6.3.5 Incorrect Print Position	289
6.3.6 Cannot Read Barcodes When Using the Barcode Check Function	290

6.4 Interface Troubleshooting	291
6.4.1 USB Interface	291
6.4.2 LAN Ethernet Interface	291
6.4.3 Bluetooth Interface	291
6.4.4 NFC Interface	292
6.4.5 RS-232C Interface	292
6.4.6 IEEE1284 Interface	292
6.4.7 External Signal Interface (EXT)	293
6.4.8 Wireless LAN Interface	293
7 Appendix	295
7.1 List of Initial Values	295
7.1.1 Printing Menu	295
7.1.2 Interface Menu	298
7.1.3 Applications Menu	308
7.1.4 System Menu	311
7.1.5 Tools Menu	313
7.1.6 Information Menu	315
7.2 Media Sensor Positions and Media Stop Positions	316
7.3 Replacing the Print Head	318
7.4 Replacing the Platen Roller	320
7.4.1 Guideline to Replace the Linerless Platen Roller (CL4NX only)	321
7.5 Optional RFID Configuration (CL4NX only)	322
7.5.1 Printing RFID Tag Errors	325
7.5.2 RFID Error and Reset Timing	329
7.5.3 External (EXT) Signal Interfaces when RFID Mode is Enabled	332
7.5.4 RFID Printing Tips	332
7.6 Optional Barcode Check Function Configuration	333
7.6.1 Basic Specifications of the Barcode Check Function	333
7.6.2 Setting Up the Barcode Checker	339
7.6.3 Changing How the RS-232C Interface is Used (When Using the KEYENCE Barcode Checkers)	340
7.6.4 Doing a Test Read with the Barcode Checker	342
7.6.5 Enabling the Barcode Check	345
7.6.6 Restrictions for the Barcode Check Function	349
7.7 Printer Specifications	351
7.7.1 Hardware	351
7.7.2 Ribbon and Media	354
7.7.3 Interface	356
7.7.4 Built-in Functions	357
7.7.5 Printer Languages	357
7.7.6 Fonts/Symbols/Barcodes	358
7.7.7 Options	361
7.7.8 Accessories	361
7.7.9 Standards	362

7.8 Interface Specifications	363
7.8.1 USB Interface	364
7.8.2 LAN Ethernet Interface	365
7.8.3 Bluetooth Interface	366
7.8.4 NFC Interface	366
7.8.5 RS-232C Interface	367
7.8.6 IEEE1284 Interface	369
7.8.7 External Signal Interface (EXT)	371
7.8.8 Wireless LAN Interface	380

This page is intentionally left blank.

Before You Start

Thank you for purchasing this SATO CL4NX/CL6NX printer (hereafter referred to as “the printer”). This manual supplies basic information on how to operate the printer. Read the manual carefully to understand each function before operation.

Features of the Product

This SATO CL4NX/CL6NX printer is a high-performance labeling system with a robust casing made of metal and equipped with versatile functions. The main features of the printer are as follows:

- Simple and stylish design
- High-quality printing
- Designed for better usability
- Equipped with high legibility TFT color 3.5 inch LCD and LED
- Onboard Guidance Videos
- Print head and platen roller can be replaced without using extra tools
- Supports a 600 m ribbon
- Supports thirty-one languages for display and forty-seven languages for printing scalable fonts
- Supports various communication interfaces
- Supports protocols such as IPv6, SNMP and NTP
- Certified by Wi-Fi alliance



- Compatible with Cisco CCX V4.0



SATO CL4NX/CL6NX printer has tested compatible with Cisco CCX, version 4.0. The Cisco Compatible logo signifies that SATO product has undergone interoperability testing by SATO together with Cisco and a third-party test house based on testing criteria set by Cisco.

SATO is solely responsible for the support and warranty of its product. Cisco makes no warranties, express or implied, with respect to SATO product or its inter operation with the listed Cisco product(s) and disclaims any implied warranties of merchantability, fitness for a particular use, or against infringement.

- Conforms to international ENERGY STAR® program



The products described herein comply with the requirements of the ENERGY STAR. As an ENERGY STAR Partner, SATO Corporation has determined that this product meets the ENERGY STAR guidelines for energy efficiency.

Safety Precautions

This section describes how to safely operate the printer. Be sure to read and understand all instructions carefully before you install and use the printer.

Pictographic Symbols

This operator manual and printer labels use a variety of pictographic symbols. These symbols show the safe and correct operation of the printer and how to prevent injury to others and property damage. The symbol explanations are as follows.

 <p>Warning</p>	<p>The Warning symbol indicates that you can cause death or serious injury if you do not follow the instruction or procedure.</p>
---	---

 <p>Caution</p>	<p>The Caution symbol indicates that you can cause injury or property damage if you do not follow the instruction or procedure.</p>
---	---

Example Pictographs











The \triangle pictograph means “Caution is required”. The pictograph includes a specified warning symbol (for example, the left symbol shows electric shock).



The \circ pictograph means “Must not be done”. The pictograph includes a specified prohibited symbol (for example, the left symbol means “Disassembly prohibited”).



The \bullet pictograph means “Must be done”. The pictograph includes a specified mandate action symbol (for example, the left symbol means “Disconnect the power plug from the outlet”).

 Warning	
<p>Place the printer on a stable area.</p>  <ul style="list-style-type: none"> Place the printer on a stable area. Do not place the printer on an unstable table, slanted surface or an area subject to strong vibration. If the printer falls off or topples, it could cause injury to someone. <p>Do not place containers filled with liquid on the printer.</p>  <ul style="list-style-type: none"> Do not place flower vases, cups, or other containers filled with liquids, on the printer. If any liquid spills into the printer, immediately power off the printer and disconnect the power plug from the outlet. Then contact your SATO reseller or technical support center. If you operate the printer in this condition, it could cause a fire or electric shock.  	<p>Do not place objects into the printer.</p>  <ul style="list-style-type: none"> Do not place metal or flammable objects inside the printer’s opening. If a foreign object gets into the printer, immediately power off the printer and disconnect the power plug from the outlet. Then contact your SATO reseller or technical support center. If you operate the printer in this condition, it could cause a fire or electric shock.   <p>Do not use other than the specified voltage.</p>  <ul style="list-style-type: none"> Do not use other than the specified voltage (AC 100 V - 240 V). Doing so could cause a fire or electric shock.

⚠ Warning

Always ground connections.



- Always connect the printer's ground wire to a ground. Not grounding the ground wire could cause an electric shock.



Handling the power cord



- Do not break or change the power cord. Do not place heavy objects on the power cord, heat it, or pull it. Doing so could cause damage to the power cord and cause a fire or electric shock.



- If the power cord becomes damaged (core is exposed, wires broken, etc.), contact your SATO reseller or technical support center. Using the power cord in this condition could cause a fire or electric shock.
- Do not change, overly bend, twist, or pull the power cord. Using the power cord in such a way could cause a fire or electric shock.



When the printer has been dropped or broken



- If the printer is dropped or broken, immediately power off the printer and disconnect the power plug from the outlet. Contact your SATO reseller or technical support center. Using the printer in this condition could cause a fire or electric shock.



Do not use the printer when something is unusual about it.



- Continuing to use the printer in the event something is unusual about it, such as smoke or unusual smells coming from it, could cause a fire or electric shock. Immediately power off the printer and disconnect the power plug from the outlet. Then contact your SATO reseller or technical support center for repairs. Under no circumstances should you attempt repairs on your own; it is too dangerous.



Do not disassemble the printer.



- Do not disassemble or modify the printer. Doing so could cause a fire or electric shock. Contact your SATO reseller or technical support center to perform internal inspections, adjustments, and repairs.



Regarding the cutter



- Do not touch the cutter with your hands, nor place objects into the cutter. Doing so could cause an injury.

Using the head cleaning fluid



- Use of flame or heat around the head cleaning fluid is prohibited. Do not heat it or subject it to flames.



- Keep the fluid out of reach of children. If a child accidentally drinks the fluid, immediately consult with a physician.

Laser beam



- Do not look into the laser radiation window of the barcode checker, and do not direct the laser beam at someone. If the laser beam hits eyes, it may cause visual disturbance.

Print head



- The print head will become hot after printing. Be careful not to touch it when replacing media or cleaning immediately after printing, to avoid being burned.
- Touching the edge of the print head immediately after printing could cause an injury. Use caution when replacing the media or cleaning the print head.
- Never replace the print head if you have not received the correct training.



Do not use in hazardous locations.



- The printer is not explosion proof certified.
- Do not use in a potentially explosive environment or atmosphere.

 **Caution**

Do not use in areas of high humidity.



- Do not use the printer in areas of high humidity or where condensation forms. If condensation forms, immediately power off the printer and do not use the printer until it dries. Using the printer while condensation is on it could cause an electric shock.

Carrying the printer



- When moving the printer, always disconnect the power cord from the outlet and check to make sure that all external wires are disconnected before moving it. Moving the printer with the wires still connected could cause damage to the cords or connecting wires, resulting in a fire or electric shock.
- Do not carry the printer while it contains media. The media could fall out and cause an injury.
- When setting the printer on the floor or a stand, be sure not to get your fingers or hands pinched under the printer feet.
- Do not carry the printer with the barcode checker stand installed. The barcode checker stand could fall out and cause injury.

Power supply



- If your hands are wet, do not operate the power button, connect the power cord or disconnect the power cord. Doing so could cause an electric shock.

Power cord



- Keep the power cord away from hot devices. Placing the power cord near hot devices could cause the cord's covering to melt and cause a fire or electric shock.
- When disconnecting the power cord from the outlet, be sure to hold the plug. Pulling the cord could expose or break the wires and cause a fire or electric shock.
- The power cord set that comes with the printer is designed especially for this printer. Do not use it with any other electrical devices.

Handling the barcode checker stand kit



- Be careful avoid injury from pointed part of the barcode checker stand kit.

Top cover



- Be careful not to get your fingers pinched when opening or closing the top cover. Also, be careful that the top cover does not slip off and drop.

Loading media



- When loading a media roll, be careful not to get your fingers pinched between the media roll and the supply unit.

When not using the printer for a long time



- When not using the printer for a long time, disconnect the power cord from the outlet to maintain safety.

During maintenance and cleaning



- When maintaining and cleaning the printer, disconnect the power cord from the outlet to maintain safety.

Precautions for Installation and Handling

Printer operation can be affected by the printer environment. Refer to the following instructions for installation and handling of the CL4NX/CL6NX printer.

Select a Safe Location

Place the printer on a surface that is flat and level.

If the surface is not flat and level, this may cause bad print quality. This may also cause a malfunction and decrease the life span of the printer.

Do not place the printer on a location that produces vibration.

Giving serious vibration or shock to the printer may cause a malfunction and shorten the life span of the printer.

Keep the printer out of high temperature and humidity.

Avoid locations subject to extreme or fast changes in temperature or humidity.

Do not place the printer in a location subject to water or oil.

Do not place the printer in a location where it will be exposed to water or oil. Water or oil entering inside the printer may cause a fire, electric shock or malfunction.

Avoid dust.

Dust build up may result in bad print quality.

Keep out of direct sunlight.

This printer has a built-in optical sensor. Exposure to direct sunlight will make the sensor less responsive and may cause the media to be sensed incorrectly. Close the top cover when printing.

Power Supply

This printer requires an AC power supply.

Be sure to connect the printer to an AC power supply.

Connect the power cord to a grounded power outlet.

Make sure that the printer is connected to a grounded power outlet.

Supply a stable source of electricity to the printer.

When using the printer, do not share its power outlet with other electrical devices that could cause power fluctuations and performance issues with your printer.

Regulatory Approval

FCC Warning

You are cautioned that changes or modifications not expressly approved by the party responsible for compliance could void your authority to operate the equipment.

This device complies with Part 15 of the FCC Rules. Operation is subject to the following two conditions: (1) this device may not cause harmful interference, and (2) this device must accept any interference received, including interference that may cause undesired operation.

This equipment has been tested and found to comply with the limits for a Class B digital device, pursuant to Part 15 of the FCC Rules. These limits are designed to provide reasonable protection against harmful interference in a residential installation. This equipment generates, uses and can radiate radio frequency energy and, if not installed and used in accordance with the instructions, may cause harmful interference to radio communications.

However, there is no guarantee that interference will not occur in a particular installation.

If this equipment does cause harmful interference to radio or television reception, which can be determined by turning the equipment off and on, the user is encouraged to try to correct the interference by one or more of the following measures:

- Reorient or relocate the receiving antenna.
- Increase the separation between the equipment and the receiver.
- Connect the equipment into an outlet on a circuit different from that to which the receiver is connected.
- Consult the dealer or an experienced radio/TV technician for help.

Shielded cable must be used in order to comply with the emission limits.

FCC Statement for Optional Wireless LAN

This device complies with RF radiation exposure limits set forth for an uncontrolled environment.

The antenna used for this transmitter must be installed to provide a separation distance of at least 20 cm from all people and must not be collocated or operating in conjunction with any other antenna or transmitter.

Bluetooth/Wireless Communication

Compliance Statement

This product has been certified for compliance with the relevant radio interference regulations of your country or region. To make sure continued compliance, do not:

- Disassemble or modify this product.
- Remove the certificate label (serial number seal) affixed to this product.

Use of this product near microwave and/or other wireless LAN equipment, or where static electricity or radio interference is present, may shorten the communication distance, or even disable communication.

Industry Canada (IC) Statement for Bluetooth

This device complies with Industry Canada license-exempt RSS standard(s). Operation is subject to the following two conditions:

- This device may not cause interference.
- This device must accept any interference, including interference that may cause undesired operation of the device.

This equipment complies with IC radiation exposure limits set forth for an uncontrolled environment and meets RSS-102 of the IC radio frequency (RF) Exposure rules. This equipment should be installed and operated keeping the radiator at least 20 cm or more away from person's body (excluding extremities: hands, wrists, feet and ankles).

Le présent appareil est conforme aux CNR d'Industrie Canada applicables aux appareils radio exempts de licence. L'exploitation est autorisée aux deux conditions suivantes :

- L'appareil ne doit pas produire de brouillage.
- L'utilisateur de l'appareil doit accepter tout brouillage radioélectrique subi, même si le brouillage est susceptible d'en compromettre le fonctionnement.

Cet équipement est conforme aux limites d'exposition aux rayonnements énoncées pour un environnement non contrôlé et respecte les règles d'exposition aux fréquences radioélectriques (RF) CNR-102 de l'IC. Cet équipement doit être installé et utilisé en gardant une distance de 20 cm ou plus entre le dispositif rayonnant et le corps (à l'exception des extrémités : mains, poignets, pieds et chevilles).

Disposal of Old Electrical & Electronic Equipment (Applicable in the European Union and other European countries with separate collection systems)



A product marked with this symbol on itself or on its packaging shall not be treated as household waste. Instead, it shall be handed over to an appropriate collection point for the recycling of electrical and electronic equipment in accordance with local regulations. Inappropriate waste handling of this product may cause detrimental consequences for the environment and damage to human health. The recycling of materials will help to conserve natural resources and contribute to your community. For more detailed information on recycling of this product, contact your local municipal organization, your household waste disposal service or the dealer where you purchased the product.

EN55022 Warning

This is a class A product.

In a domestic environment, this product may cause radio interference, in which case the user may be required to take adequate measures.

EN55022 Warnung

Warnung! Dies ist eine Einrichtung der Klasse A.

Diese Einrichtung kann im Wohnbereich Funkstörungen verursachen. In diesem Fall kann vom Betreiber verlangt werden, angemessene Maßnahmen durchzuführen.

Das Gerät ist nicht für die Benutzung im unmittelbaren Gesichtsfeld am Bildschirmarbeitsplatz vorgesehen. Um störende Reflexionen am Bildschirmarbeitsplatz zu vermeiden, darf dieses Produkt nicht im unmittelbaren Gesichtsfeld platziert werden.

机器名称: 条码打印机

部件名称	有毒有害物质或元素					
	铅 (Pb)	汞 (Hg)	镉 (Cd)	六价铬 (Cr6+)	多溴联苯 (PBB)	多溴二 苯醚 (PBDE)
印刷电路板	×	○	○	○	○	○
电源、交流转换器 电池	×	○	○	○	○	○
热敏头、液晶显示屏	×	○	○	○	○	○
电动机、切纸机	×	○	○	○	○	○
树脂 (ABS、PC等)	×	○	○	○	○	○
金属 (铁、非铁金属)	×	○	○	○	○	○
电缆等	○	○	○	○	○	×
包装材料 (纸盒等)	○	○	○	○	○	○

本表格依据SJ/T 11364的规定编制。

- ：表示该有毒有害物质在该部件所有均质材料中的含量均在GB/T 26572 “电子信息产品中有毒有害物质的限量要求”的标准规定以下。
- ×：表示该有毒有害物质至少在该部件的某一均质材料中的含量超出GB/T 26572 “电子信息产品中有毒有害物质的限量要求”的标准规定。

环保使用期限



本标志中的年数，是根据2006年2月28日公布的“电子信息产品污染防治管理办法”和SJ/T11364“产品污染防治标识要求”，适用于在中华人民共和国（除台湾、香港和澳门外）生产或进口的电子信息产品的“环保使用期限”。在遵守使用说明书中记载的有关本产品安全和使用上的注意事项、且没有其他法律和规定的免责事由的情况下，在从生产日开始的上述年限内，产品的有毒、有害物质或元素不会发生外泄或突变，使用该产品不会对环境造成严重污染或对使用者人身、财产造成严重损害。

注1)：“环保使用期限”不是安全使用期限。尤其不同于基于电气性能安全、电磁安全等因素而被限定的使用期限。产品在经适当使用后予以废弃时，希望依照有关电子信息产品的回收和再利用的法律与规定进行处理。

注2)：本标志中的年数为“环保使用期限”，不是产品的质量保证期限。对于同一包装内包含电池、充电器等附属品的产品，产品和附属品的环保使用期限可能不同。

1

Parts Identification

1.1 Parts Identification of the Printer

1.1.1 Front View

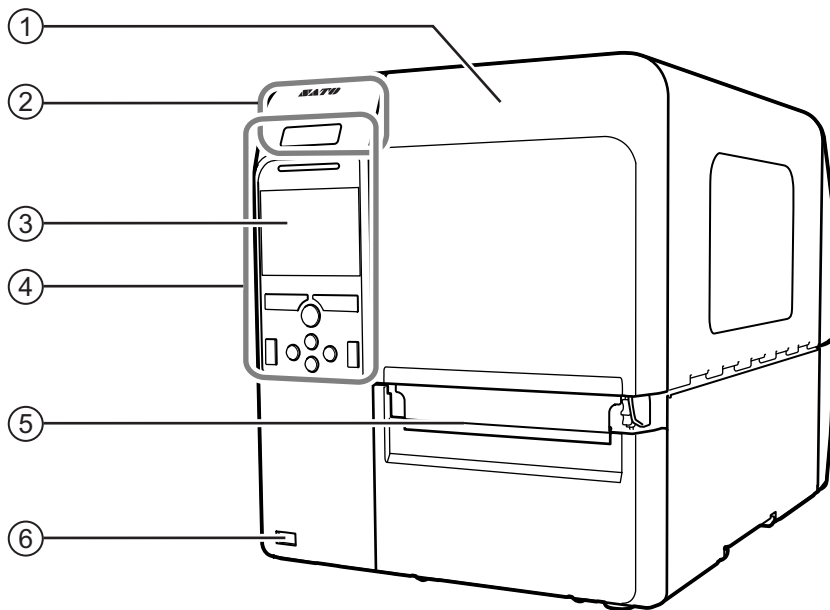

① **Top cover**

② **NFC antenna location**

*This feature is supported on printers from serial number 6B~ and above.

③ **Color LCD**

④ **Operator panel**

⑤ **Media discharge outlet**

⑥ **USB connector (Type A)**

Enable the storage of printer setting information with USB memory and for connecting other devices like a barcode checker, barcode scanner or a keyboard.

⚠ CAUTION

Be sure to perform a virus check for the USB memory before connecting it to the printer. SATO Corporation shall not be held responsible for any printer malfunctions caused by a virus spread via USB memory.

Note

The pictures in this manual show the CL4NX unless otherwise stated.

1.1.2 Rear View

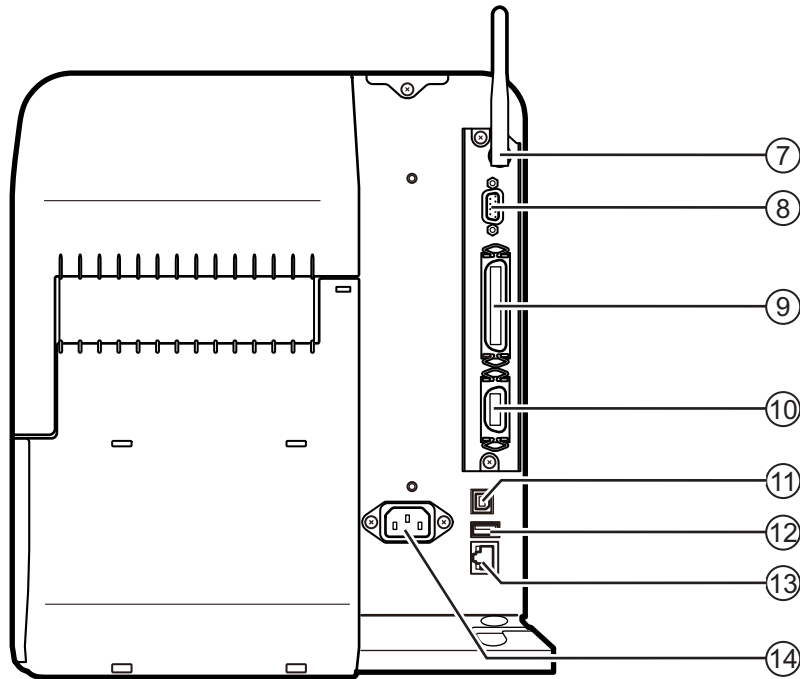

- 7 Wireless LAN antenna (optional)**
Connector for installation of optional wireless LAN antenna.
- 8 RS-232C connector**
To connect the printer to the computer using the RS-232C serial interface.
You can also connect a barcode checker.
Usage of the RS-232C interface can be selected in the **Interface > RS-232C > Interface** menu.
- 9 IEEE1284 connector**
To connect the printer to the computer using the IEEE1284 interface.
- 10 EXT connector (External signal interface)**
Interface connector for external signals.
Connect an optional device to this terminal.
- 11 USB connector (Type B)**
To connect the printer to the computer using the USB interface.

- 12 USB connector (Type A)**
Enable the storage of printer setting information with USB memory and for connecting other devices like a barcode checker, barcode scanner or a keyboard.

CAUTION

Be sure to perform a virus check for the USB memory before connecting it to the printer. SATO Corporation shall not be held responsible for any printer malfunctions caused by a virus spread via USB memory.

- 13 LAN connector**
To connect printer to the network using the LAN interface.
- 14 AC input terminal**
Supplies power to the printer through the inserted power cord.
Before connecting, make sure that the AC voltage of your region is in the range of AC 100 to 240 V, 50 to 60 Hz.

1.1.3 Internal View

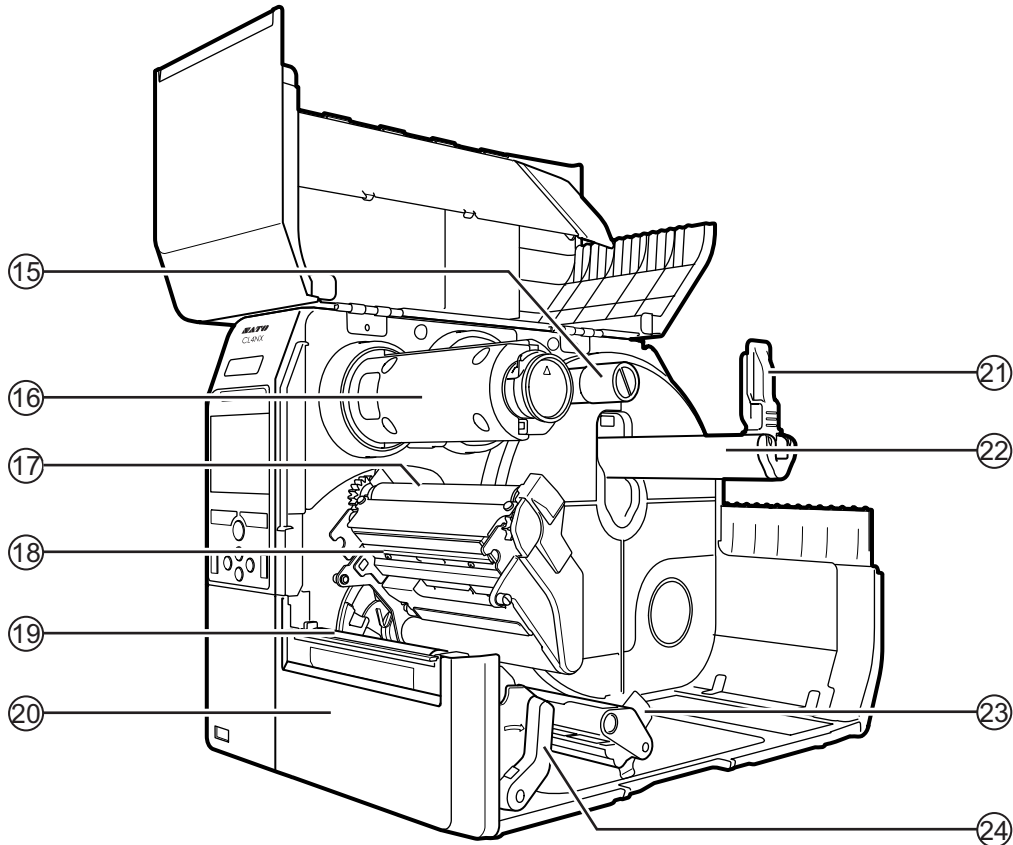

- | | |
|--|--|
| <p>①⑤ Ribbon supply spindle</p> <p>①⑥ Ribbon rewind spindle</p> <p>①⑦ Ribbon roller</p> <p>①⑧ Print head (Consumables)
Creates an image directly on the media or by using a ribbon. Highest print quality is achieved when regular maintenance is performed.</p> <p>①⑨ Platen roller (Consumables)</p> <p>②⑦ Front cover</p> | <p>②① Media holder guide
Used to hold the media roll.</p> <p>②② Media roll holder
Hang the media roll to the bar.</p> <p>②③ Media guide</p> <p>②④ Head lock lever
Used to release the print head assembly.</p> |
|--|--|

1.2 Parts on the Operator Panel

1.2.1 Operator Panel

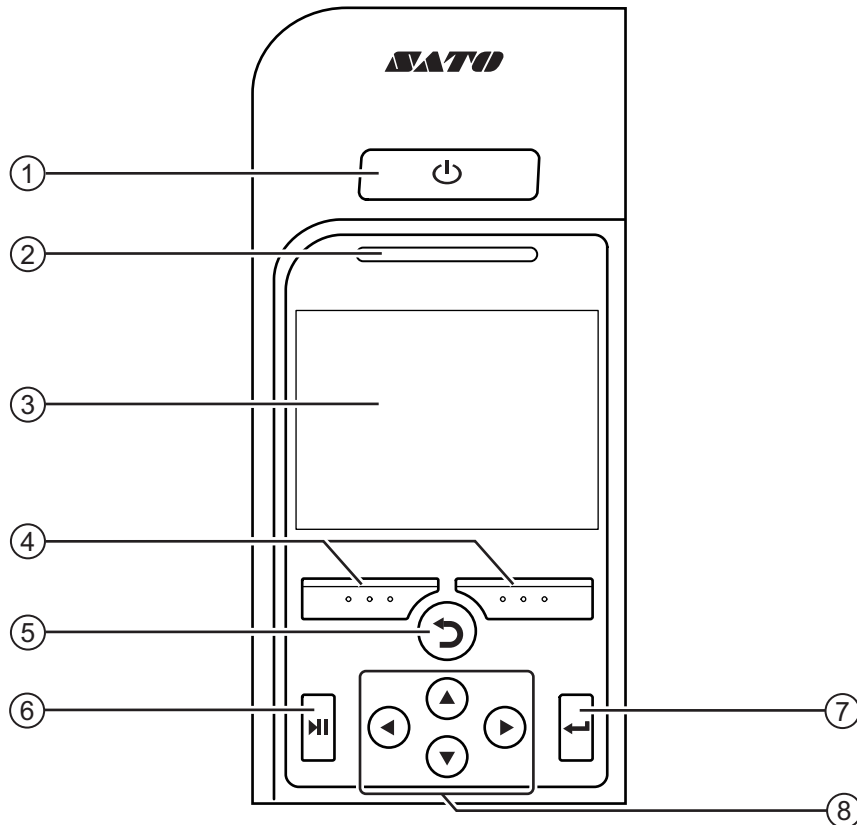

① **Power button**

Press the  power button until the LED lights up in blue to power on the printer.

Press the  power button for more than two seconds to power off the printer.

② **LED indicator**

③ **Color LCD**

④ **Soft buttons**

The functions change depending on the screen. The functions of the buttons are indicated on the bottom of the screen.

(For example, when in offline mode, left soft button: ONLINE; right soft button: FEED)

⑤ **Back button**

Returns to the previous screen.

⑥ **Line button**

Toggle between online/offline mode or playback/pause the video.



⑦ **Enter button**

Confirm the selected item or setting value.

⑧ **Arrow buttons**

Navigate the selection in the screen menu.

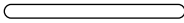
1.2.2 LED Indicator

LED Indicator	Color	Description
	Blue	Online mode
	(Light off)	Power off or offline mode
	Red	Printer error (For example, when the ribbon runs out)
 Flashes at intervals of two seconds.	Blue	Sleep mode (energy saving mode)

Note

- If the printer enters sleep mode during a printer error status (LED lights red), the LED indicator will flash blue at intervals of two seconds.
- By default, the printer goes into sleep mode after 60 minutes of inactivity. Refer to [Section 4.4.5 System Menu](#) to change the period before the printer enters sleep mode.

This page is intentionally left blank.

2

Installing the Printer

2.1 Installation Precautions

Install this printer in a location as follows:

- A location that is horizontal and stable.
- A location that has sufficient space for operating the printer.

Do not install this printer in a location as follows. Doing so could cause the printer to malfunction.

- A location that is subject to vibration.
- A location with high temperature and humidity.
- A dusty location.
- A location exposed to direct sunlight.
- A location with a lot of electrical noise.
- A location with a large fluctuation in power.
- A location with an explosive atmosphere (flammable gas or vapor).

2.2 Installation Space

Make sure that there is sufficient space around the printer so that the top cover can be fully opened when operating or cleaning the printer, or replacing consumables.

2.2.1 Front View (CL4NX)

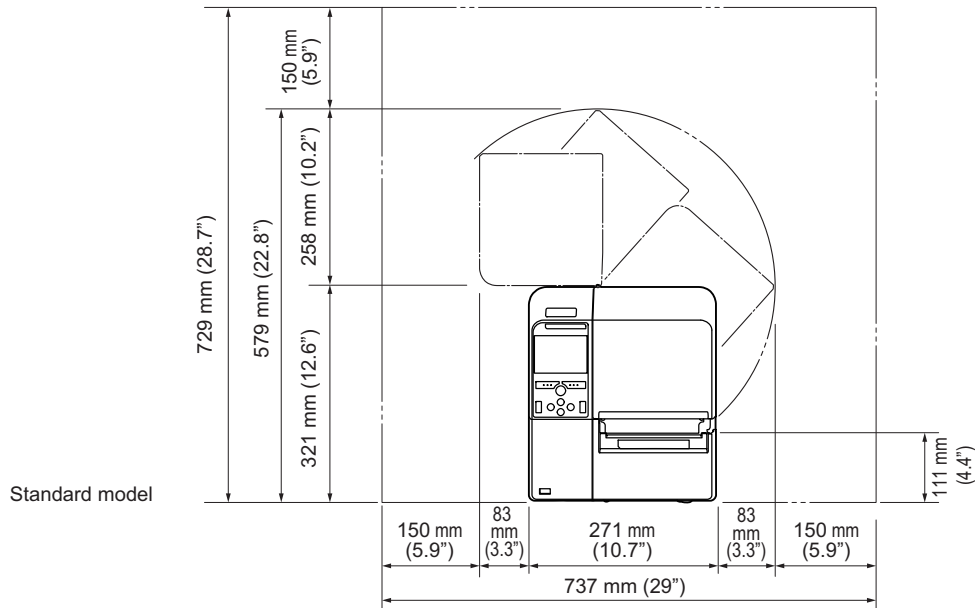

2.2.2 Front View (CL6NX)

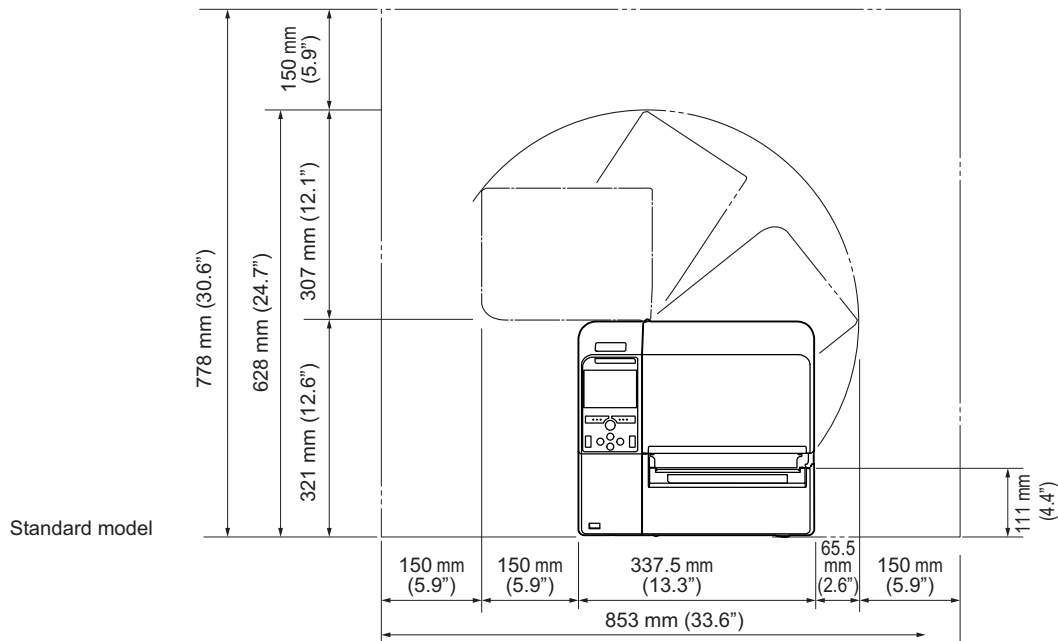

2.2.3 Side View (CL4NX/CL6NX)

Make sure that there is sufficient space on the rear side of the printer so that no stress is applied to the power cord or cables connected to the printer.

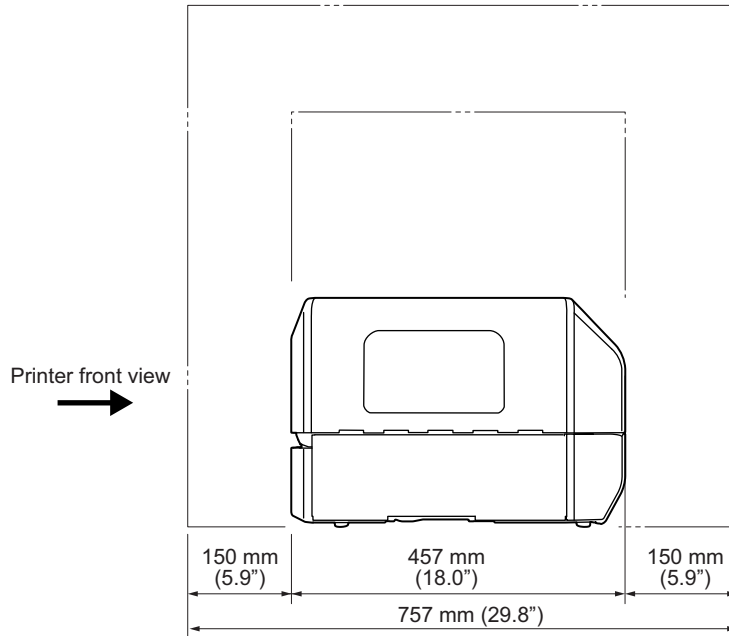

2.2.4 Bottom View (CL4NX)

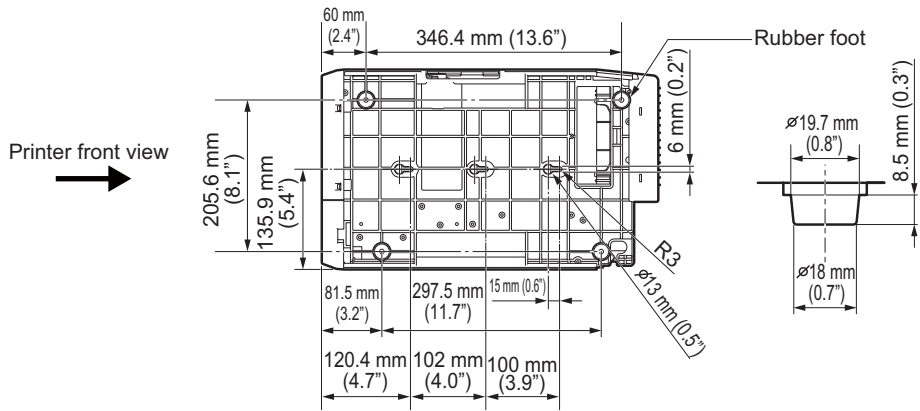

2.2.5 Bottom View (CL6NX)

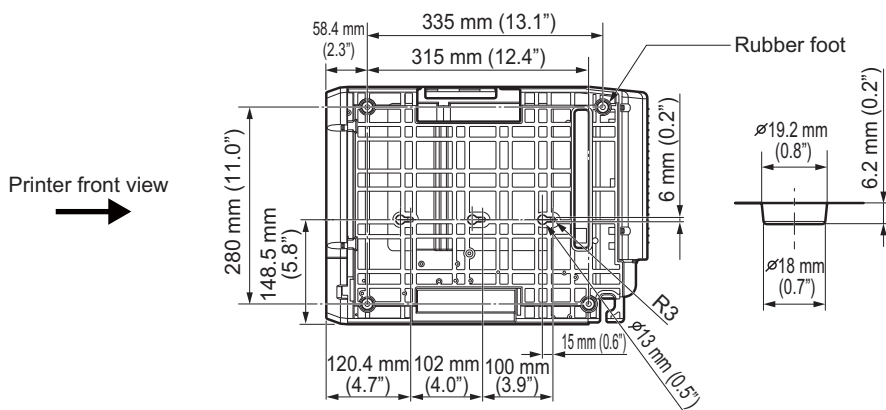

2.3 Checking the Bundled Accessories

After unpacking the printer, make sure that you have all the bundled accessories: if there are any missing items, contact the SATO reseller where you purchased the printer.

User documents
(Quick guide, Warranty, etc.)

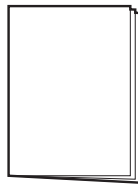

AC power cord*

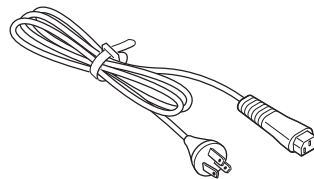

* The shape of power plug varies depending on the region in which it was purchased.

Note

Keep the packaging box and cushioning material after installing the printer. You can pack the printer with this packaging box for shipment when requesting for repairs.

2.4 Connecting the Interface Cable

The connection of the interface cable is explained as follows:

2.4.1 Available Interfaces

This printer supports the following interfaces.

A printer connected with multiple interface cables can continue to operate when receiving data.

However, you cannot receive data from more than one interface at a time. Normally, do not use multiple interfaces at a time.

The printer prints the received data in the reception order. The next received data is stored in the receive buffer while the first data is printed.

- NFC (front side)
*This feature is supported on printers from serial number 6B~ and above.
- USB
- LAN
- Bluetooth
- RS-232C
- IEEE1284
- External signal (EXT)
- Wireless LAN

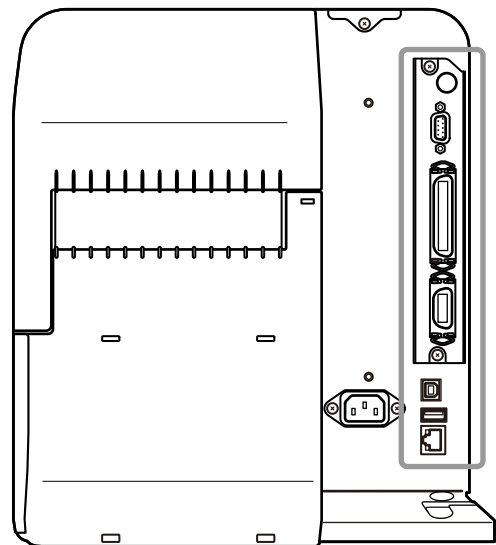

Note

- The wireless LAN interface is optional.
- The NFC interface supports the handover function that simplifies the Bluetooth/Wi-Fi connection setup with Android devices. For details, refer to [Section 2.4.3 NFC Interface Connection](#).
In addition, the NFC interface can be used for changing printer settings with an Android device while the printer is powered off and the power cord is not connected.

CAUTION

Do not connect or disconnect the interface cables (or use a switch box) with power supplied to either the printer or computer. This may cause damage to the interface circuitry in the printer or computer and is not covered by warranty.

2.4.2 Interface Settings

You can set the various interface settings of the printer through **Interface** in the **Settings** menu. For details, refer to **Interface** in chapter 4 **Operation and Configuration**.

2.4.3 NFC Interface Connection

The NFC interface of the printer supports a handover function that simplifies the Bluetooth/Wi-Fi connection setup with Android devices.

The handover function only performs the connection setup, such as the pairing and authentication with NFC, and passes the actual interface to the more advanced Bluetooth and Wi-Fi when communicating between NFC supported devices. In general, the pairing and authentication require some procedures to enter authentication information, but the connection can be completed simply by holding the Android devices over the printer while using NFC.

Touch the NFC antenna ① of the printer with the NFC mark on the Android device.

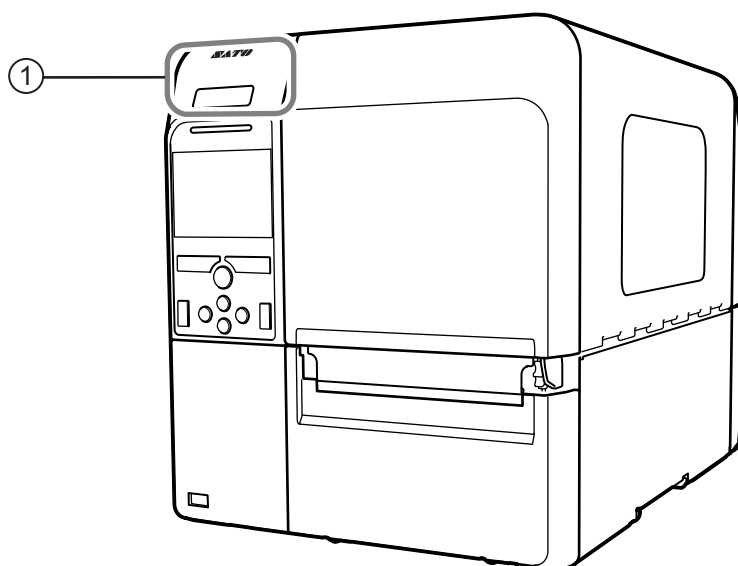

Note

- This feature is supported on printers from serial number 6B~ and above.
- If it does not communicate well, shift the Android device to the front, back, left and right, and then hold it up again.
- For the operation of the NFC for the Android device, refer to the user manual for the Android device.

2.5 Connecting the Power Cord

WARNING

- Do not touch the power button, connect or disconnect the power cord while your hands are wet. Doing so could cause an electric shock.
 - Always connect the ground wire to a ground terminal. Electric shock could occur if you do not.
-

CAUTION

- The attached power cord is designed exclusively for this printer.
 - Do not use the attached power cord with other devices.
-

1 Connect the power cord to the **AC input terminal** ① at the rear of the printer.

Take note of the orientation of the connector.
Secure the printer with one hand, and insert the connector tightly.

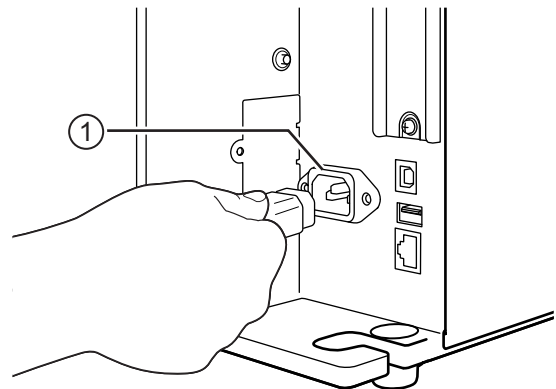

2 Insert the power plug into an AC outlet.

Make sure that the AC voltage of your region is in the range of AC 100 - 240 V, 50 - 60 Hz. If your local voltage is not in the stated range, contact your SATO reseller or technical support center.

*The shape of the power plug varies depending on the region in which it was purchased.

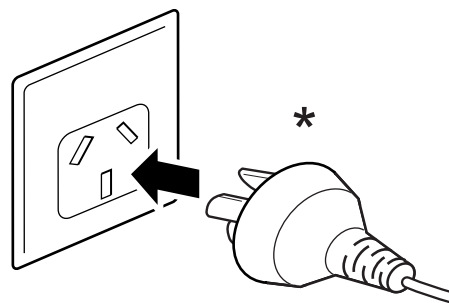

Note

This product is also designed for IT power distribution system with phase-to-phase voltage 230 V.

2.6 Power On/Off the Printer

WARNING

Do not touch the power button, connect or disconnect the power cord while your hands are wet. Doing so could cause an electric shock.

CAUTION

An incorrect power on/off operation may damage the printer settings. In such a case, the printer settings are reset to their default values. It is always recommended to use the power button to allow proper shutdown of the printer and ensure changes made to menu settings are saved appropriately.

Note

You can power on/off the printer from the main power source by enabling **Start on AC** under the **System** menu.

2.6.1 Power On the Printer

- 1 Press the  power button on the operator panel until the LED lights up in blue to power on the printer.

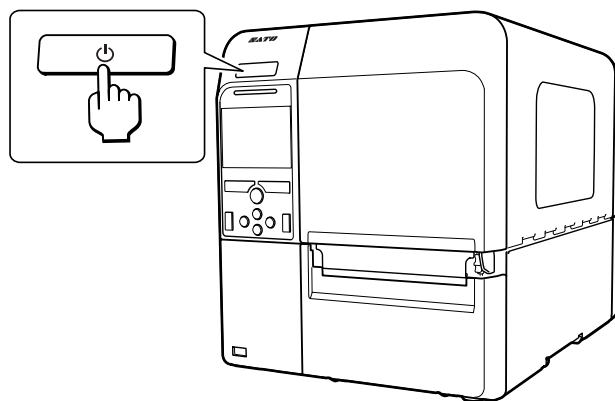

- 2 **Online** shows on the screen.



2.6.2 Power Off the Printer

CAUTION

- Do not power off the printer during operation, such as when printing or updating. Doing so could cause a malfunction of the printer.
 - Do not disconnect the power cord until the powering off process is completed on the printer.
-

1 Make sure that the printer is in offline mode before you power off.

If **Online** shows on the screen, press the **▶▶** button to change to offline mode.



2 Press the  power button for more than two seconds to power off the printer.

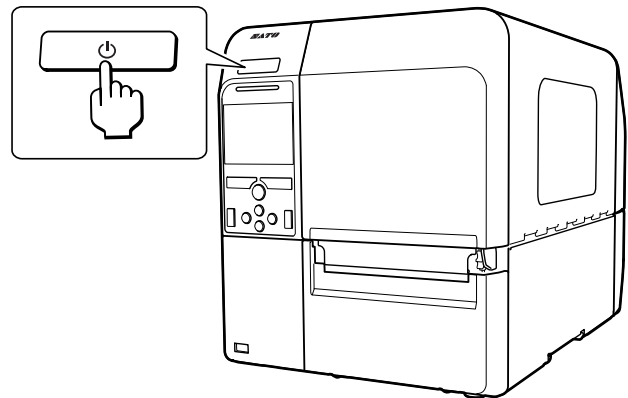

2.7 Starting Up the Printer (Startup Guide)

When you power on the printer for the first time after purchase, the display shows the startup guide. The startup guide is a function to help you through the initial printer configuration, such as setting date and time, and loading the ribbon and media.

You can cancel the startup guide and perform the configuration later from the menu.

*If you have installed the optional RTC (Real Time Clock) kit, the time zone, date and time setting screens show.

2.7.1 Startup Screen

The startup screen shows when you first power on the printer.

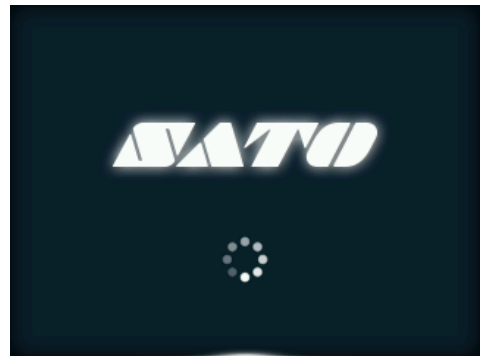

2.7.2 Language Selection

Select the display language.

Select the language name using the ▲/▼ buttons, then press the right soft button or ← button to confirm.



2.7.3 Region Setting with Optional RTC

Set the region (time zone).
Select the region using the ▲/▼ buttons, then press the right soft button or ← button to confirm.

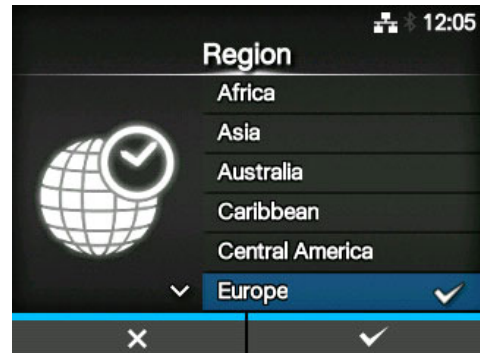

2.7.4 City Setting with Optional RTC

Set the city (time zone).
Select the city using the ▲/▼ buttons, then press the right soft button or ← button to confirm.

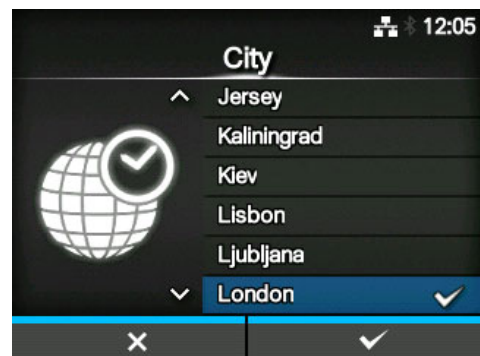

2.7.5 Date Setting with Optional RTC

Set the date.
Select the current value using the ▲/▼ buttons, and move the cursor using the ◀/▶ buttons.
When you have completed the date setting, press the right soft button or ← button to confirm.

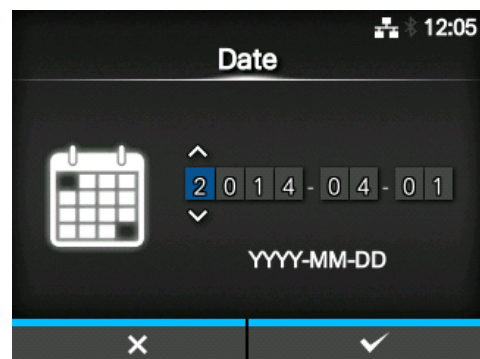

2.7.6 Time Setting with Optional RTC

Set the time.

Select the current value using the ▲/▼ buttons, and move the cursor using the ◀/▶ buttons. When you have completed the time setting, press the right soft button or ↵ button to confirm.

Note

The time is set in 24-hour format.

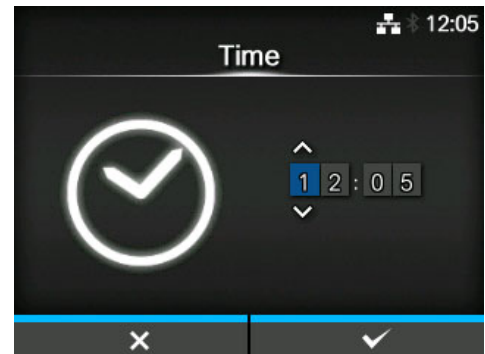

2.7.7 Print Method Setting

Set whether to use the ribbon or direct thermal media to print.

The options are as follows:

- **Use Ribbon:** Print with a ribbon.
- **Direct Thermal:** Print using direct thermal media.

Select the print method using the ▲/▼ buttons, then press the right soft button or ↵ button to confirm.

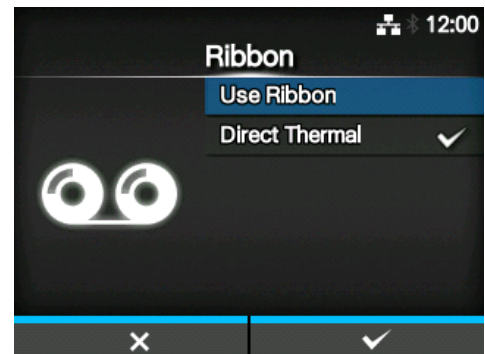

2.7.8 Ribbon Setting

Load the ribbon.

*Shows if you have selected **Use Ribbon** in the print method setting.

You can check the setting method of the ribbon through the video. Press the  button to watch the video.

Press the  button to stop the video and return to the previous screen.

After you complete the ribbon setting, press the right soft button to go to the next screen.

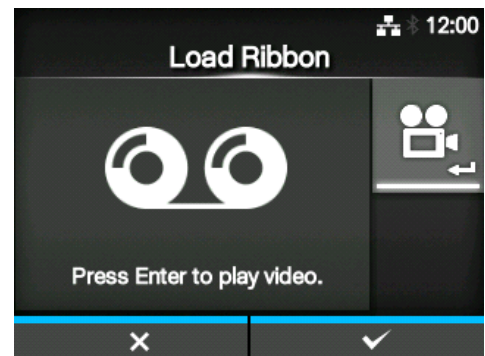



2.7.9 Setting the Media Sensor Type

Set the type of sensor for sensing the media.

The available options will vary depending on the default print mode of your printer.

The options are as follows:

- **None:** Disable the media sensor.
- **Gap:** Use the transmissive type sensor.
- **I-Mark:** Use the reflective type sensor.

Select the media sensor type using the  /  buttons, then press the right soft button or  button to confirm.

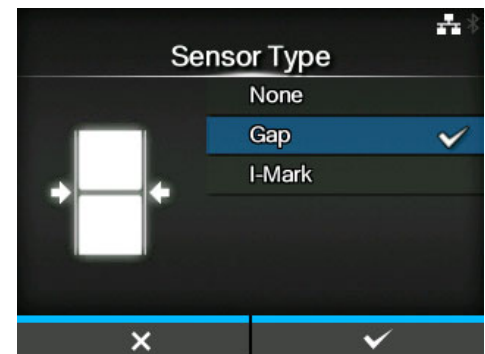

2.7.10 Media Setting

Load the media.



You can check the setting method of the media through the video.

Press the  button to select video mode.

Note (for CL4NX only)

When you are using the linerless model, the video is shown immediately after the  button is pressed.

The selection screen of the video for playback shows. (Not available for linerless model of CL4NX.)

Select the video to playback using the  /  buttons, then press the right soft button or  button to playback the video.

The options are as follows:

The options vary depending on the printer model.

Standard Model and Cutter Model

- **Roll:** Shows the video on how to load the media roll.
- **Fanfold:** Shows the video on how to load the fan-fold media.

Dispenser Model

- **Dispenser:** Shows the video on how to eject the liner out of the printer.
- **Rewinder:** Shows the video on how to rewind the liner in the printer.

Press the  button to stop the video and return to the previous screen.

After you complete the media setting, press the right soft button to go to the next screen.

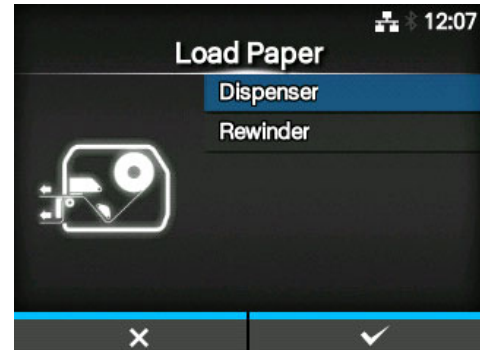
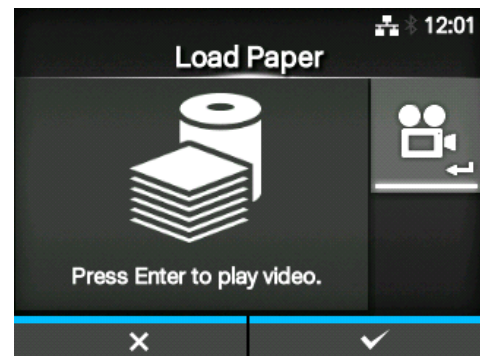

2.7.11 Confirmation Screen

This screen shows when the startup guide completes.

If you want the startup guide to show the next time you start up, press the left soft button. If not, press the right soft button.

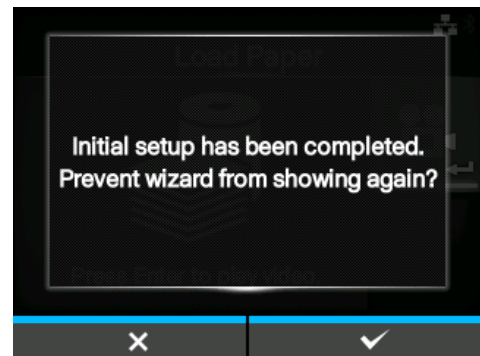

When you press one of the soft buttons, the printer automatically feeds the media (to the print head position) and enters online mode.



Note

You can enable or disable the startup guide in [Startup Guide](#) under the **Tools** menu.

2.7.12 Startup Guide Cancelation

You can cancel the startup guide at any time. When you press the left soft button on the setting screen, the screen to the right shows. Select whether or not to show the startup guide during the next startup using the ▲ / ▼ buttons, and press the right soft button to confirm. To cancel and return to the startup guide setting, press the left soft button.

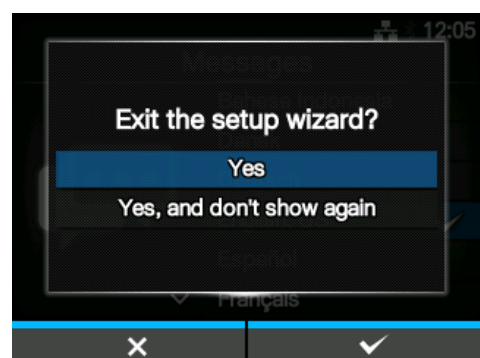

Note

- You can enable or disable the startup guide in [Startup Guide](#) under the **Tools** menu.
- Even if you cancel the startup guide during play, the printer will save the settings you have changed.

3

Loading the Ribbon and Media

This printer supports two types of print methods, thermal transfer and direct thermal. Thermal transfer printing transfers the ink of the ribbon to the media. Direct thermal printing creates the image on direct thermal media. Ribbon is not necessary if you are using direct thermal media.

3.1 Checking the Ink Side of the Ribbon

There are two wind directions for the ribbon. Face-out means the ink is on the outer side and Face-in means the ink is on the inner side. This printer supports both wind directions. You can examine the ink side of the ribbon using the following procedure:

- 1** Place the outer side of the ribbon onto the media (touching).
- 2** Scratch the inner side of the ribbon with your fingernail or a pointed object.
- 3** If there is a mark on the media, the ink is coated on the outer side of the ribbon.

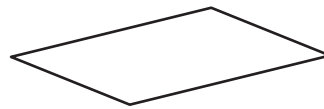
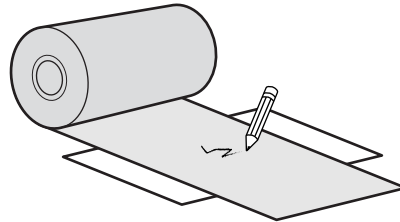

The ink is coated on the inner side. (Face-in ribbon)



The ink is coated on the outer side. (Face-out ribbon)

3.2 Loading the Ribbon

Use genuine SATO media and ribbons for the printer, for optimum print quality.

CAUTION

- The print head and its surroundings are hot after printing. Be careful not to touch it, to avoid being burned.
- Touching the edge of the print head with your bare hand could cause injury.

The routing path of the ribbon is shown in the right picture.

-  Face-in ribbon
-  Face-out ribbon

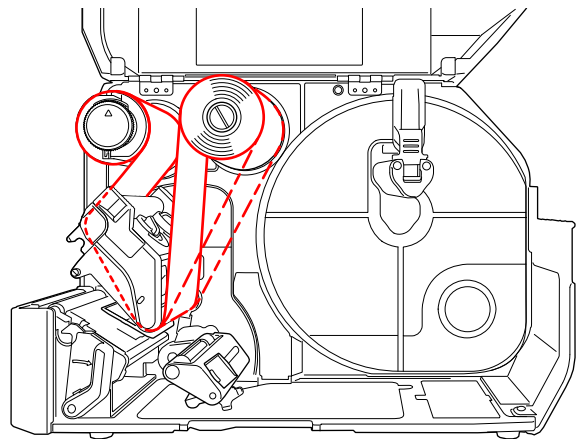

Note

You can also refer to the sticker located on the inner side of the top cover.

1 Open the top cover ①.

CAUTION

Open the top cover fully to prevent accidental drop of the cover.

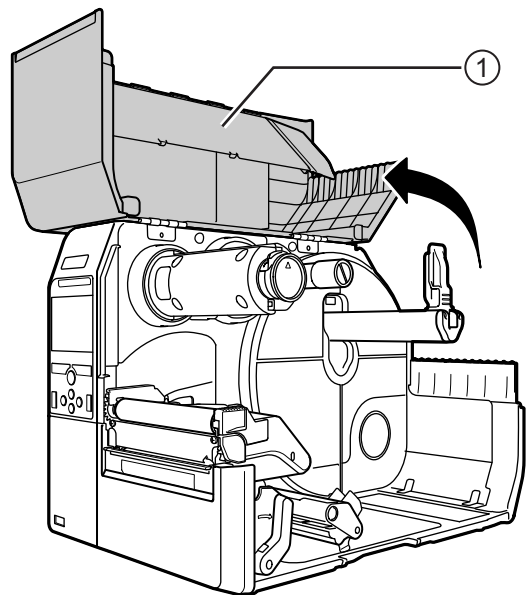

- 2** Push the **ribbon rewind spindle** ② all the way in.

If there is any ribbon on the ribbon rewind spindle, remove it from the spindle before installing new ribbon.

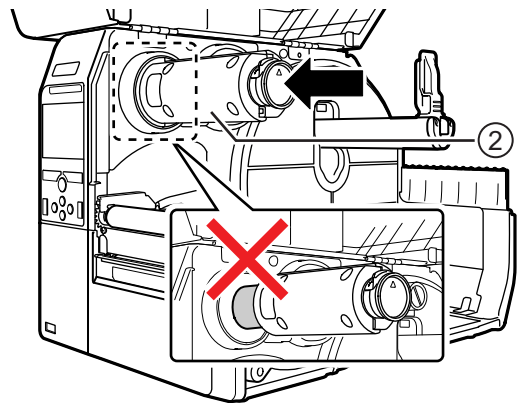

- 3** Push the **head lock lever** ③ towards the rear.

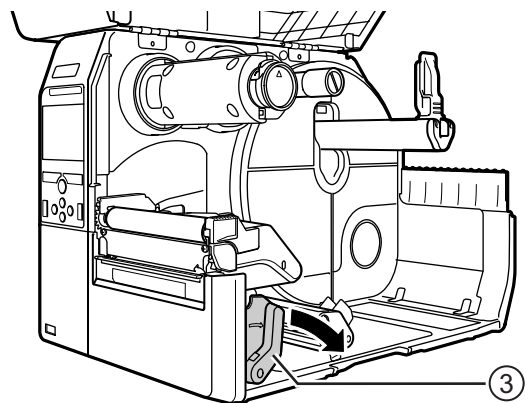

- 4** Load the **ribbon** ④ onto the **ribbon supply spindle** ⑤.

While taking note of the wind direction, insert the ribbon all the way in.

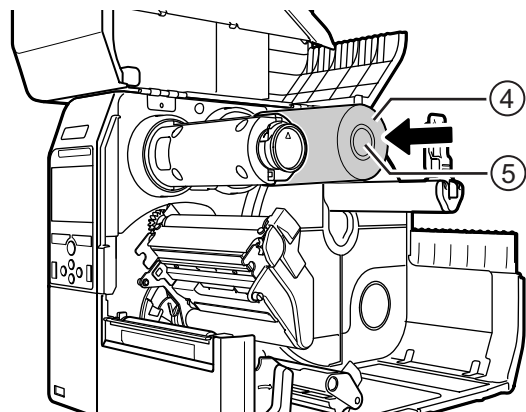

5 From the **ribbon supply spindle** ⑤, pass the ribbon below the **print head** ⑥.

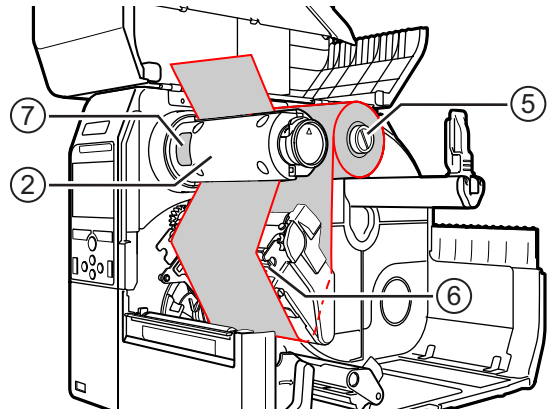

6 Wind the ribbon counterclockwise to the **ribbon rewind spindle** ② and **grip sheet** ⑦.

Turn the ribbon rewind spindle counterclockwise for several rounds, to wind the ribbon.

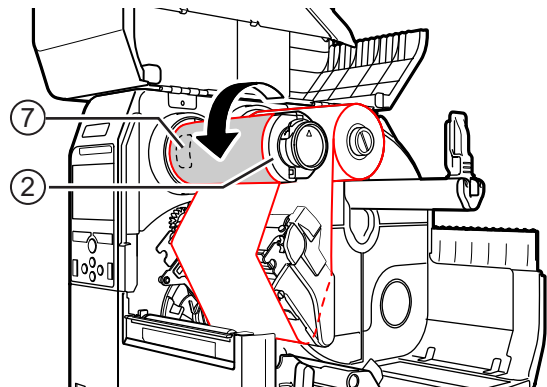

7 If the media is already loaded, press the **print head** down until the **head lock lever** is locked.

If the media is not loaded, continue with [Section 3.5 Loading Media](#).

8 Close the **top cover**.

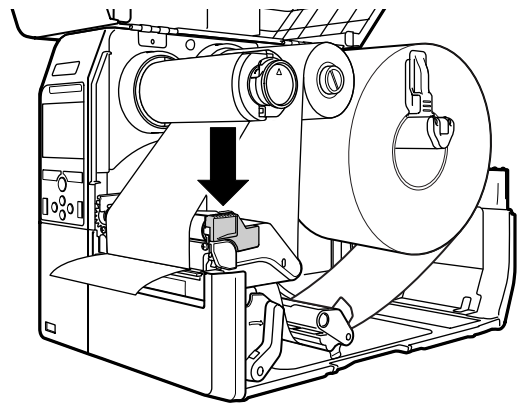

3.3 Removing the Ribbon

- 1** Press the **tab** ① on the tip of the **ribbon rewind spindle** to pull it out.
- 2** Pull to remove the used ribbon from the **ribbon rewind spindle**.
- 3** Push the **ribbon rewind spindle** all the way in.

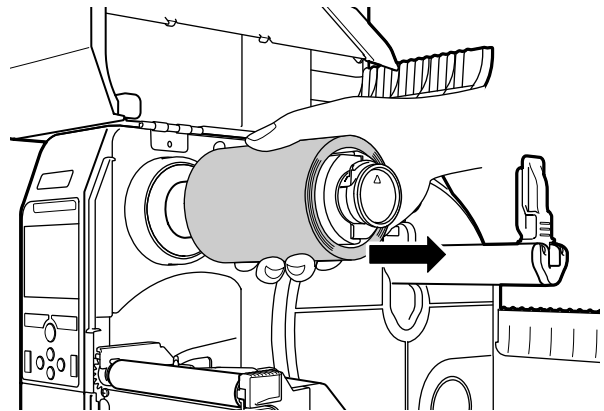
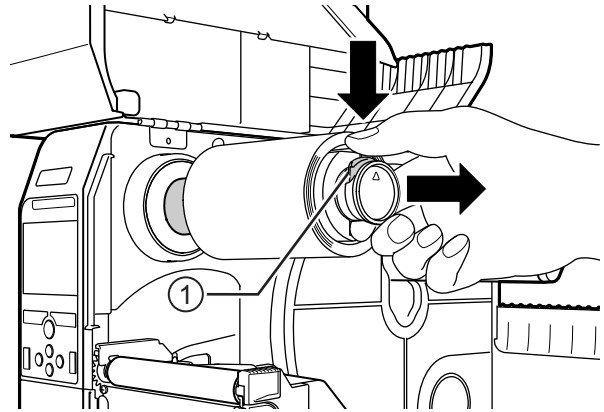

3.4 Usable Media

This printer can print on two types of media; media roll and fan-fold media. The printer uses media sensors to detect I-marks or Gaps on the media in order to precisely print the content.

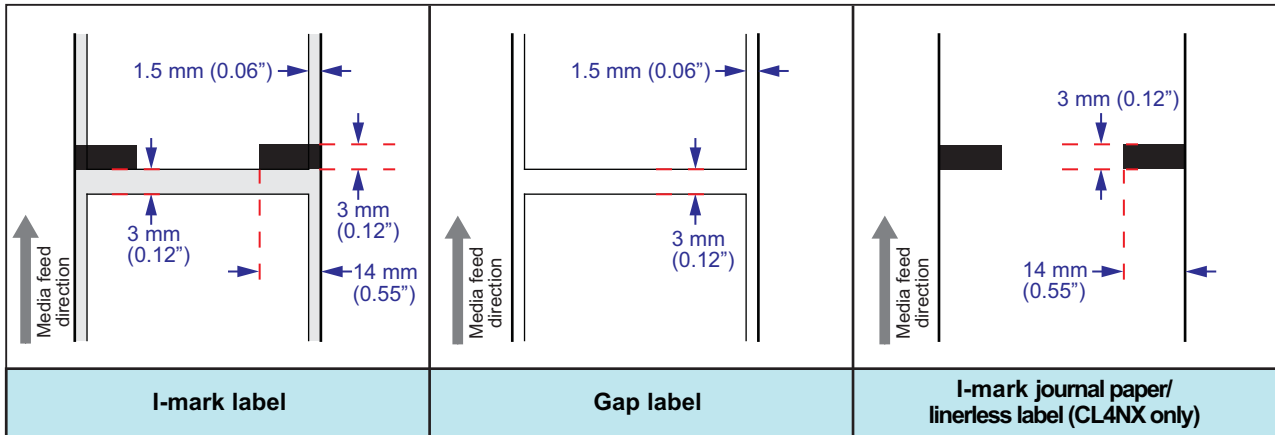

3.4.1 Adjusting the Position of the Media Sensor

When you use nonstandard media (for example, media with printing on the underside, or media with a special shape), the media sensor cannot sense the I-mark or Gap of the media correctly. In such a case, adjust the position of the media sensor to sense the I-mark or Gap correctly.

Adjust the media sensor guide to the position where it can sense the I-mark or Gap of the media.

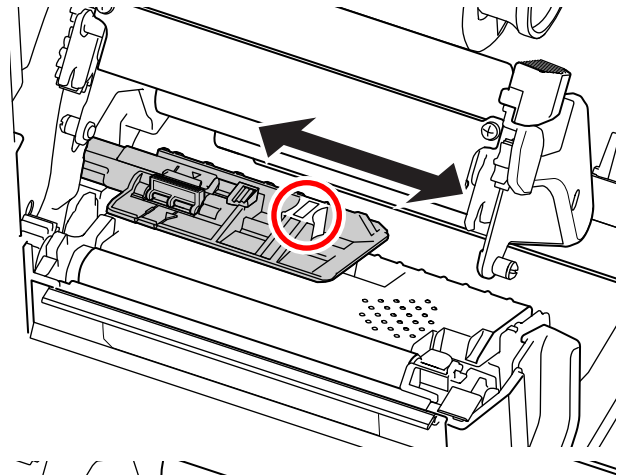

The I-mark sensor is below the □ mark, and the Gap sensor is below the ▽ mark.

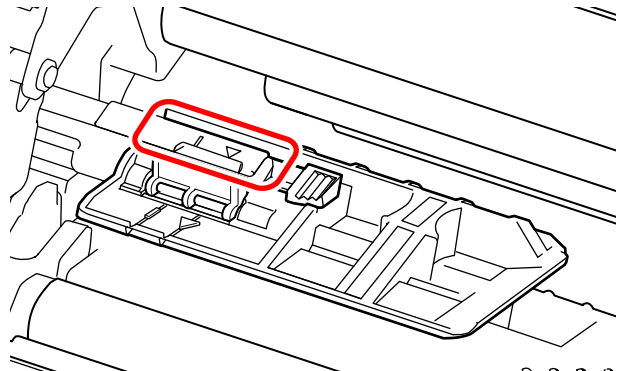

3.5 Loading Media

Use genuine SATO media and ribbons for the printer, for optimum print quality.



CAUTION

- The print head and its surroundings are hot after printing. Be careful not to touch it, to avoid being burned.
- Touching the edge of the print head with your bare hand could cause injury.

3.5.1 Loading Media Roll

The routing path of the media is shown in the right picture.

When loading the media, make sure that the print side is facing up.

-  Face-in media
-  Face-out media

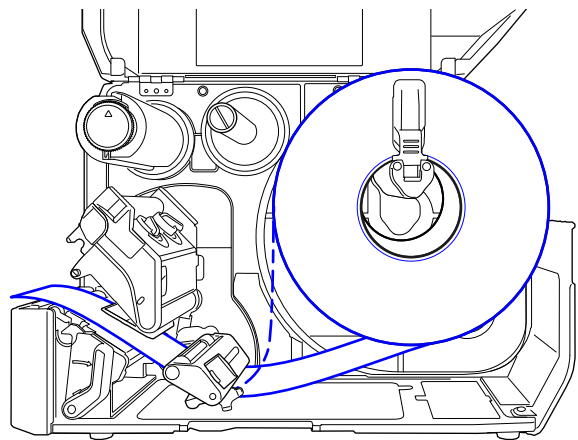

- 1** Open the **top cover**.

CAUTION

Open the top cover fully to prevent accidental drop of the cover.

- 2** Push the **head lock lever** towards the rear to unlock the print head.

3 Pull the **media holder guide** ① and **media guide** ② away from the printer.

Turn the **knob** ③ counterclockwise to release the media guide.

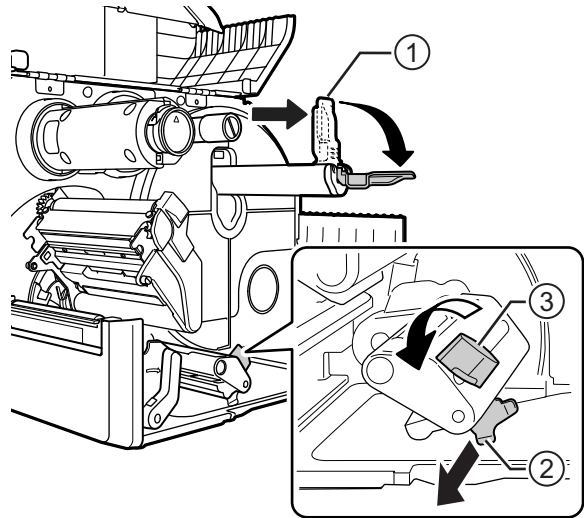

4 Load the media in the **media holder** ④. Make sure that the media roll is all the way in to inside of the printer.

5 Push the **media holder guide** ① lightly against the media roll.

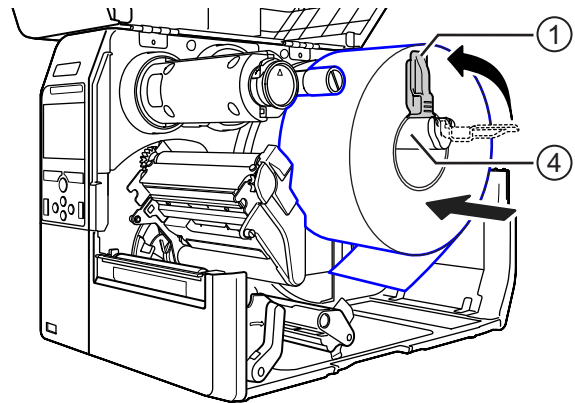

6 Pass the media below the **media damper** ⑤ and **media sensor guide** ⑥ while pushing the media to inside of the printer.

Make sure that the end of the media extends out the front of the printer.

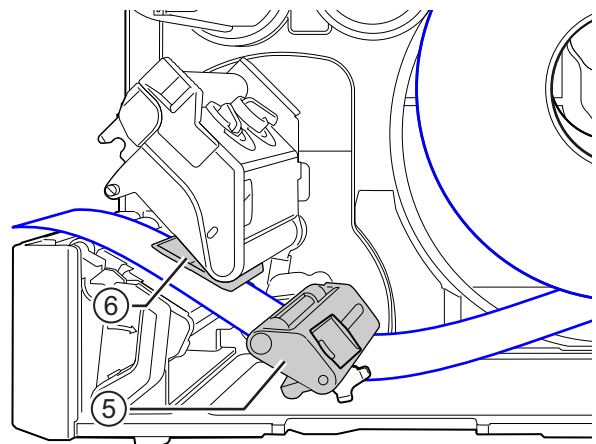

- 7** Press the **print head** down until the **head lock lever** is locked.
- 8** Press the **media guide** ② lightly against the end of the media, then turn the **knob** ③ to lock the media guide.
- 9** Close the **top cover**.
- 10** After loading the media and ribbon, perform a test print to make sure that the media is loaded correctly.
Refer to the **Test Print** menu in **Section 4.4.6 Tools Menu** for details on how to perform a test print.

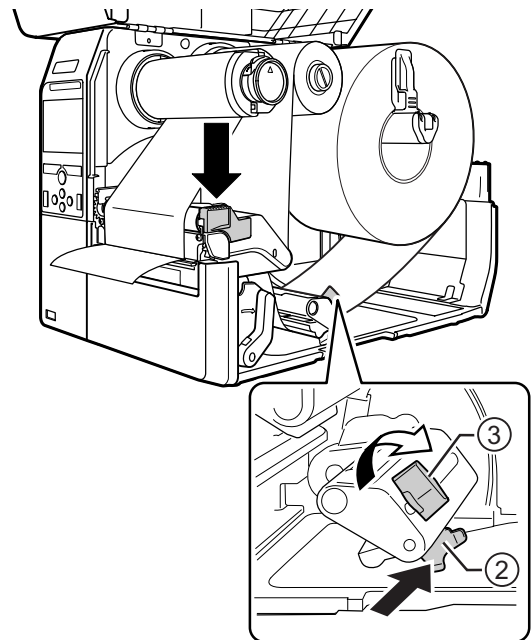

! CAUTION

When closing the top cover, be careful not to pinch your fingers.

3.5.2 Loading Fan-fold Media

Place the fan-fold media on a flat location, then load the media from the media slot on the rear or the bottom of the printer.

The routing path of the media is shown in the right picture.

When loading the media, make sure that the print side faces up.

After passing the media through the slot, refer to steps 5 through 10 of **Section 3.5.1 Loading Media Roll** to load the media.

 Load the media from the rear of the printer.

 Load the media from the bottom of the printer.

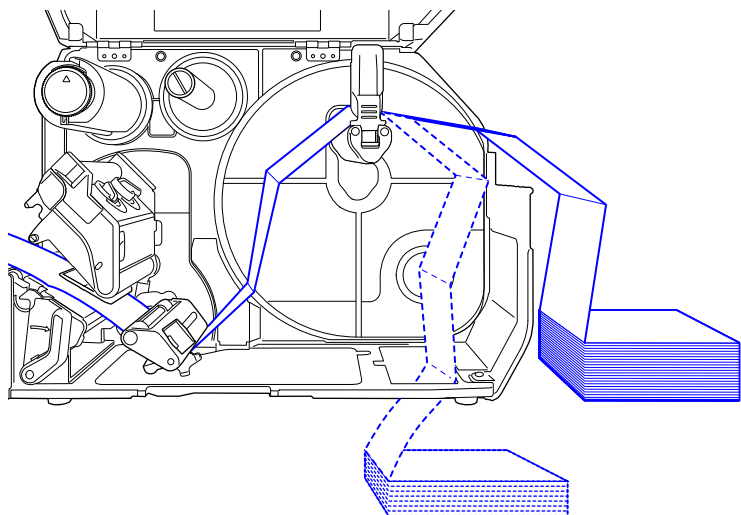

Note

If a media jam frequently occurs with the media being loaded from the bottom of the printer, change the load location to the rear of the printer.

3.5.3 Loading Media with the Optional Cutter

Refer to the procedure in [Section 3.5.1 Loading Media Roll](#) or [Section 3.5.2 Loading Fan-fold Media](#) to load the media.

For models with a cutter installed, pull the **tab** ① of the **cutter unit** in the direction shown, then open up the cutter-open lever before passing the media through it.

After loading media, close the cutter-open lever and then push the **tab** ① in the reverse direction to lock it.

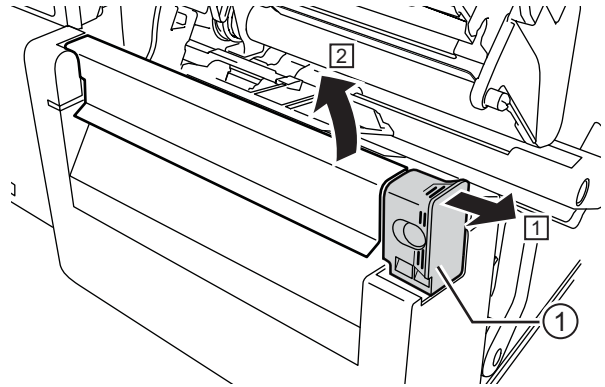

CAUTION

Be careful not to touch the cutter blade.

3.5.4 Loading Media with an Optional Dispenser and Liner Discharge Outlet

This section describes the procedure to dispense the label and eject the liner out of the printer.

1 Refer to steps 1 through 6 of [Section 3.5.1 Loading Media Roll](#) to load the media.

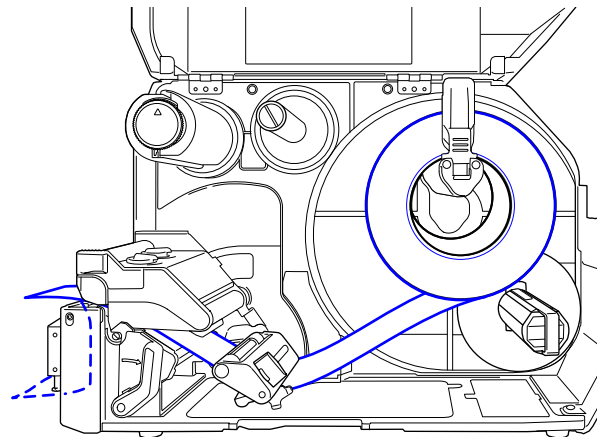

2 Press the **tab** ① at the front of the printer to open the **dispenser unit** ②.

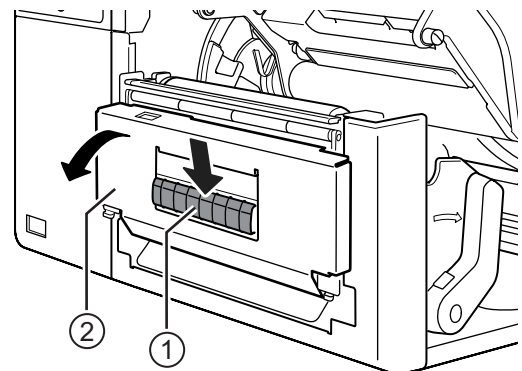

- 3** Remove about 30 cm (11.8") of labels ③ from the liner ④, then pass the liner ④ through the gap of the dispenser unit to the outside of the printer.
- 4** Adjust the **dispenser roller** ⑤ to the center of the label.
- 5** Close the **dispenser unit**.
- 6** Close the **print head and top cover**.

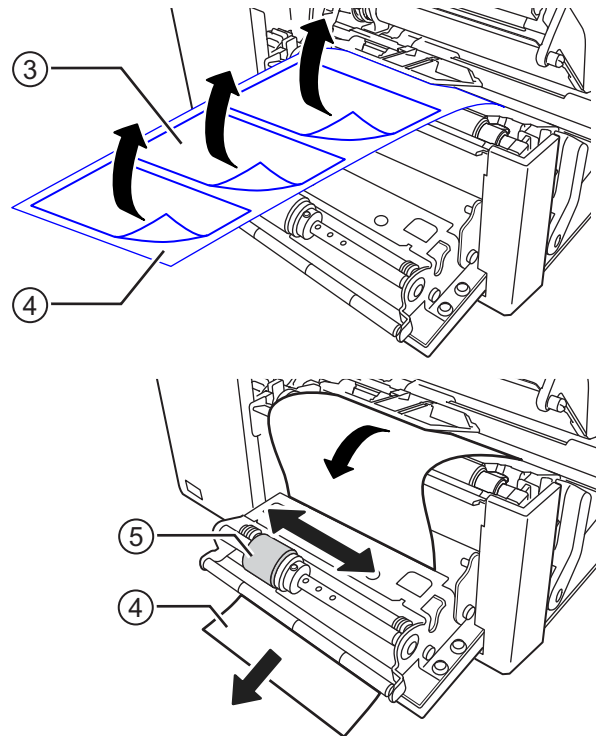



3.5.5 Loading Media with an Optional Dispenser and Liner Rewinder

This section describes the procedure to dispense the label and rewind the liner in the printer.

Note

The maximum diameter of the liner that can be rewound in the printer is 120 mm (4.72").

The routing path of the media is shown in the right picture.

-  Label
-  Liner

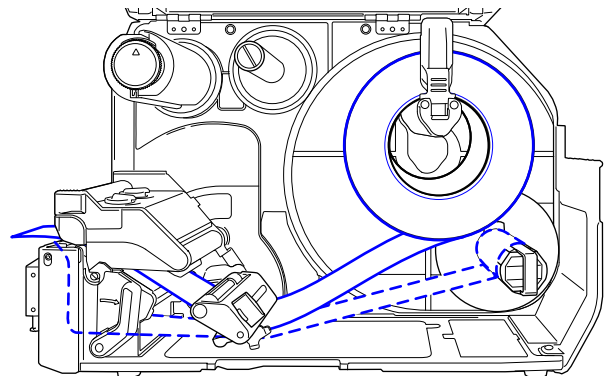

- 1 Refer to steps 1 through 7 of **Section 3.5.1 Loading Media Roll** to load the media.
- 2 Press the **tab** ① at the front of the printer to open the **dispenser unit** ②.

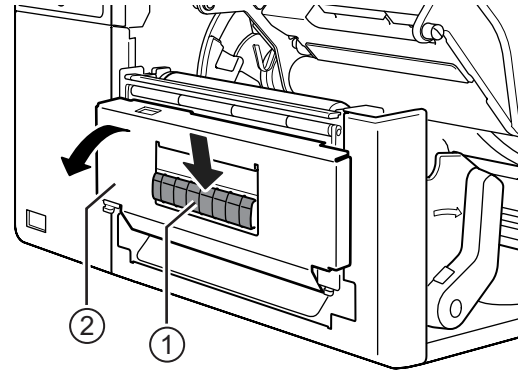

- 3 Remove about 80 cm (31.5") of labels ③ from the liner ④, then pass the liner ④ through the gap of the **dispenser unit** to the inside of the printer.
- 4 Adjust the **dispenser roller** ⑤ to the center of the label.

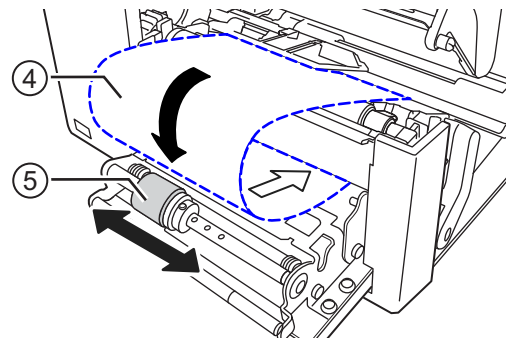
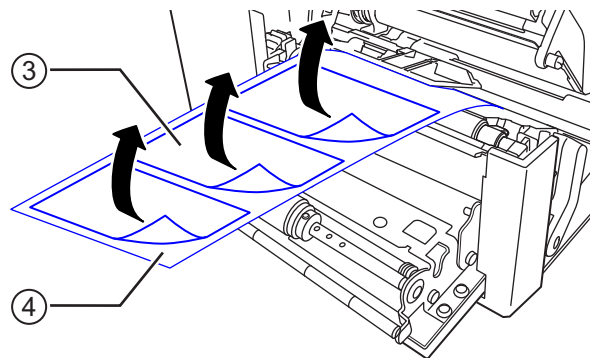

- 5 Pass the liner ④ below the **liner rewriter** ⑥, then attach it with the **clip** ⑦.
- 6 Rotate the **liner rewriter** ⑥ counterclockwise by hand, to wind the liner.
- 7 Close the **dispenser unit**.
- 8 Close the **print head** and **top cover**.

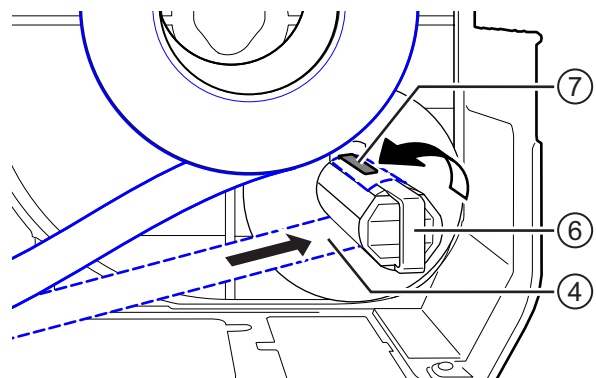

3.5.6 Removing the Liner from the Rewinder

- 1** Pull the clip ① away from the printer then pull to remove the liner ②.
- 2** Place the clip back to its original position.

Note

The rewinder can take up maximum a diameter of 120 mm (4.72") of liner.

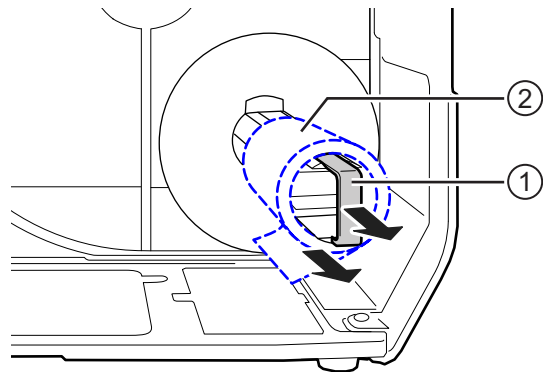

This page is intentionally left blank.

4

Operation and Configuration

The display of the printer varies depending on the following modes:

- Online mode: refer to [Section 4.1.1 Online Mode/Offline Mode](#).
- Offline mode: refer to [Section 4.1.1 Online Mode/Offline Mode](#).
- Error display: refer to [Section 4.1.3 Error Icon](#).
- Settings mode: refer to [Section 4.2 Settings Mode](#).

4.1 Display and Operation

4.1.1 Online Mode/Offline Mode

In online mode, you can execute the print job.

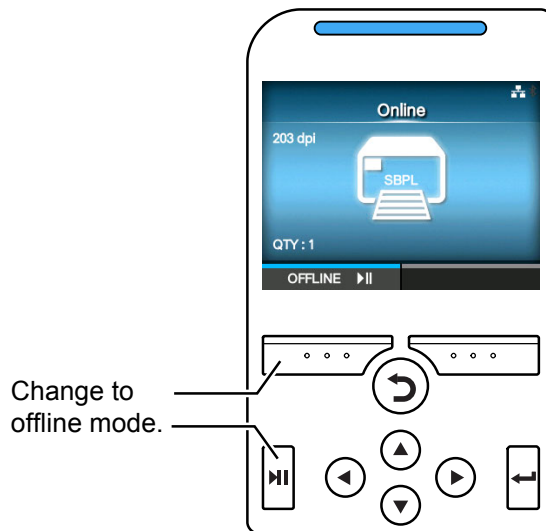

In offline mode, the print job will stop.

You can adjust the print settings, cancel the print job or feed the media.

After you complete or cancel the print job, you can show the settings mode.

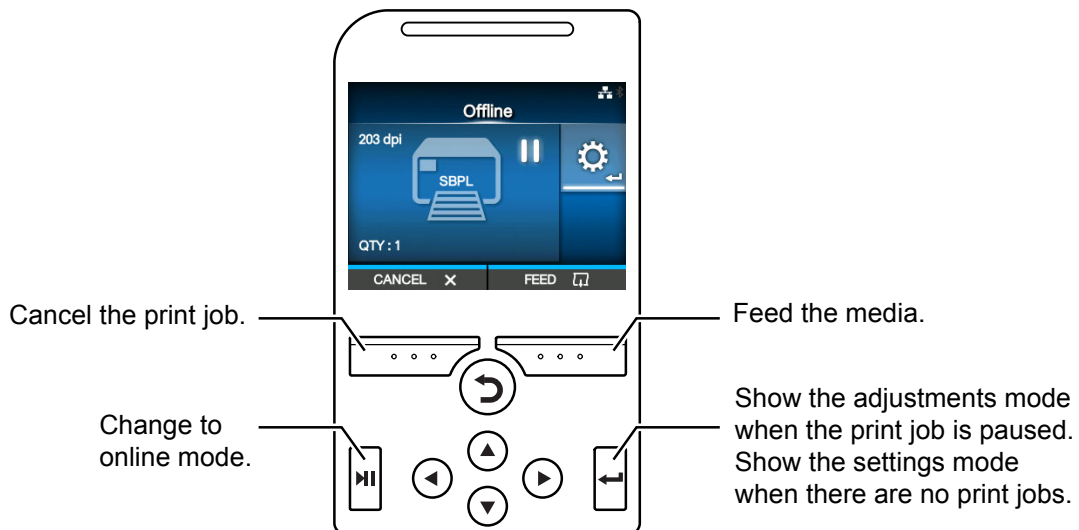











4.1.2 Status Icon

The icons on the status bar of the display show the printer status.



- Communication Interface Status

Icon	Description
	Bluetooth is enabled but not connected.
	Bluetooth is enabled and connected.
	Network link is enabled but not connected.
	Network link is enabled and connected.
	NFC is enabled but not connected.
	NFC is enabled and connected.
	Not connected to the NTP time server.
	Wi-Fi is not connected.
	Wi-Fi is connected. Signal Level: 1
	Wi-Fi is connected. Signal Level: 2

Icon	Description
	Wi-Fi is connected. Signal Level: 3
	Wi-Fi is connected. Signal Level: 4
	Wi-Fi Direct is not connected.
	Wi-Fi Direct is connected. Signal Level: 1
	Wi-Fi Direct is connected. Signal Level: 2
	Wi-Fi Direct is connected. Signal Level: 3
	Wi-Fi Direct is connected or the printer is set to act as an access point. Signal Level: 4
	Printer is connected to USB host.
	Waiting for external input/output signal.
	RFID mode is enabled (CL4NX only).
	Standard code is disabled (Non-standard code).

- USB Memory Status

Icon	Description
	USB memory is connected.

- Barcode Checker Status







Icon	Description
	Barcode checker is connected.

4 Operation and Configuration





- Barcode Scanner Status

Icon	Description
	Barcode scanner is connected in AEP mode.

- Print Job Status

Icon	Description
	Waiting for media removal. Remove the media.
	Ribbon is near the end. Prepare a new ribbon.
	Label is near the end. Prepare new media.
	Command error detected. Check the print data.
	Receive buffer is nearly full. Wait until the printer starts printing the previously sent data, and then send the next data.
	Defective print head is detected. Replace the print head.
	Incompatible print head is detected. Replace the print head.

- Maintenance Status

Icon	Description
	Clean the print head or platen roller.
	Replace the print head.
	Replace the platen roller.
	Replace the cutter unit.

4.1.3 Error Icon

When a printer error occurs, the error status shows on the screen with an icon. When an error occurs, you can perform the following operations:



- Change to offline mode.
- Cancel the error.
- Feed the media.
- Change to settings mode.
- Change to guidance video.



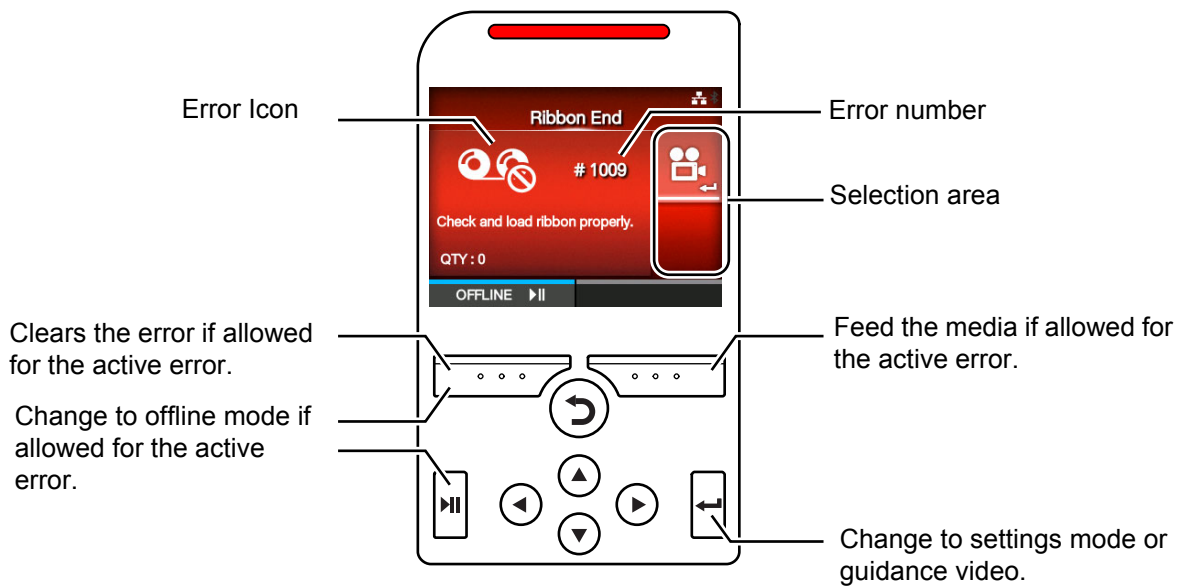





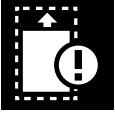

Note



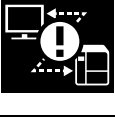





The available operations vary, depending on the situation.

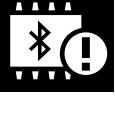

- Error Icon

Icon	Description
	Paper end is detected.
	Ribbon end is detected.

Icon	Description
	Print data is larger than the media size.
	Sensor error is detected.
	Print head is unlocked.
	Print head error is detected.
	<ul style="list-style-type: none"> • Communication error is detected. • BCC error is detected. • CRC error is detected.
	Receive buffer overflow.
	Cutter error is detected.
	<ul style="list-style-type: none"> • USB memory is not accessible. • There is no free space in the USB memory.
	Calendar error is detected.
	<ul style="list-style-type: none"> • Writing/reading information to/from the RFID tag failed (CL4NX only). • With Non-RFID warning enabled and RFID tag loaded, the items received do not contain an RFID issue command (CL4NX only).
	<ul style="list-style-type: none"> • Wireless LAN setting error is detected. • Authentication with the server failed. • Authentication with the server timed out.

Icon	Description
	Printer error is detected.
	The temperature of the print head has exceeded the tolerance range.
	RFID module is defective (CL4NX only).
	Bluetooth module is defective.
	Paper jam is detected. (CL4NX only)
	NFC error is detected.
	NFC command error is detected.
	The barcode checker is not detected at printer startup or at the start of printing when the barcode check mode is enabled.
	<ul style="list-style-type: none"> • The barcode could not be read. • The read result of the barcode does not match the command data.

4.1.4 Guidance Video

The printer contains the following guidance videos for visual reference of printer operations.

No.	Guidance Video	Show video from		
		Error screen	Startup Guide	Information menu
1	Media roll loading (Standard)	-	Possible	Possible
2	Media roll loading (Cutter)	-	Possible	Possible
3	Media roll loading (Linerless) (CL4NX only)	-	Possible	Possible
4	Media roll loading (Dispenser)	-	Possible	Possible
5	Media roll loading (Dispenser with rewinder)	-	Possible	Possible
6	Fan-fold media loading (Standard)	-	Possible	Possible
7	Fan-fold media loading (Cutter)	-	Possible	Possible
8	Ribbon loading	-	Possible	Possible
9	Media roll replacement (Standard)	Possible	-	Possible
10	Media roll replacement (Cutter)	Possible	-	Possible
11	Media roll replacement (Linerless) (CL4NX only)	Possible	-	Possible
12	Media roll replacement (Dispenser)	Possible	-	Possible
13	Media roll replacement (Dispenser with rewinder)	Possible	-	Possible
14	Fan-fold media replacement (Standard)	Possible	-	Possible
15	Fan-fold media replacement (Cutter)	Possible	-	Possible
16	Ribbon replacement	Possible	-	Possible
17	Print head replacement	-	-	Possible
18	Platen roller replacement	-	-	Possible
19	Cleaning	-	-	Possible

You can play the guidance video using the following procedures:

- **To play the guidance video from the error screen**

1 On the error screen, press the **←** button to play the guidance video.

If there are more videos to choose from, press the arrow buttons to select the guidance video, then press **←** button.
The guidance video starts.

2 Follow the procedures to resolve the error according to the guidance video.



- To get access to the guidance video in online mode

- 1 Press the **▶||** button in online mode.
The printer enters offline mode.



- 2 Press the **←** button.
The printer enters settings mode.



- 3 Select **Information** using the **◀/▶** buttons.

- 4 Press the **←** button.
The item list shows.

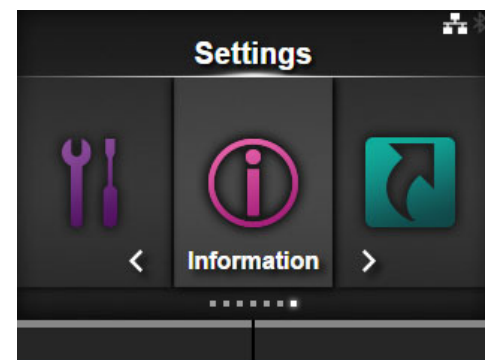

- 5 Select **Help** using the **▲/▼** buttons.

- 6 Press the **←** button.
The list of guidance videos shows.

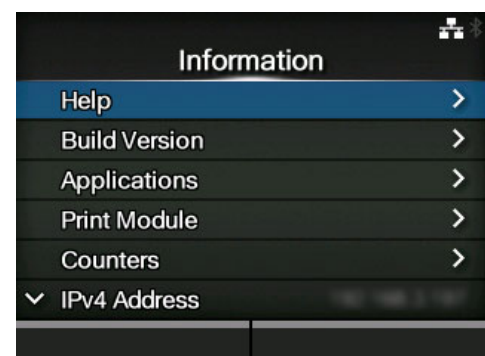

- 7** Select the video for playback using the ▲/▼ buttons, then press the ← button.
The guidance video starts.

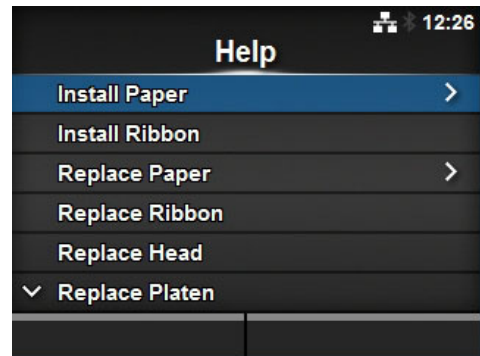

The guidance video operating procedures are described below:

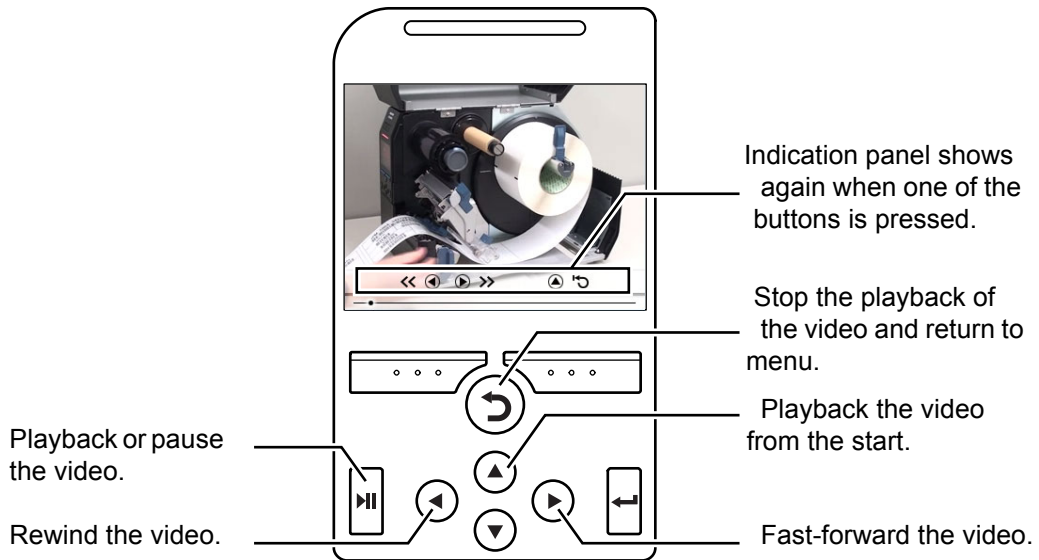

4.1.5 Adjusting the Print Settings During Printing

Follow the procedure below to adjust the print position, print darkness and print speed during printing.

1 Press the **▶||** button to pause print job and change the printer to offline mode.

2 Press the **←** button.
The Adjustments menu shows.



3 Select an item and adjust the setting.
For details on how to adjust settings, refer to [Section 4.2 Settings Mode](#).

Adjustments	
Offset	0 dot
Pitch	0 dot
Speed	6 ips
Darkness Range	A
Darkness	5
Darkness Adjust	50

4 Press the **↶** button to return to offline mode.

5 Press the **▶||** button to change to online mode.
The print job resumes with the adjusted settings.

Note

When **Prioritize** in the **Printing > Advanced** menu has been set to **Commands** and the print settings have been specified by command, the changes made in the Adjustments menu will be applied only to the data already analyzed at that time. The settings specified by command will be applied to the rest of the data.

4.1.6 Canceling the Print Job

Cancel the print job according to the following procedure. When the print job is canceled, the data stored in the receive buffer of the printer is also deleted.

1 Press the **▶||** button to change the printer to offline mode.

2 Press the left soft button.

A message shows, confirming that you want to cancel the print job.

3 Press the right soft button.

The print job will be canceled.

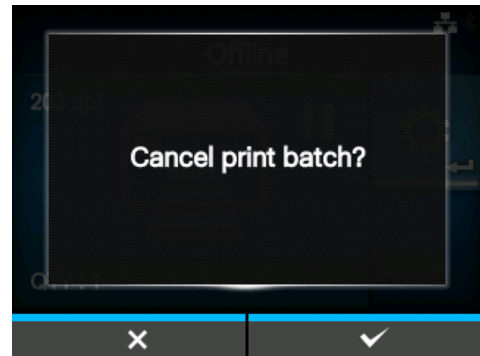

4.2 Settings Mode

In settings mode, the following menus show:

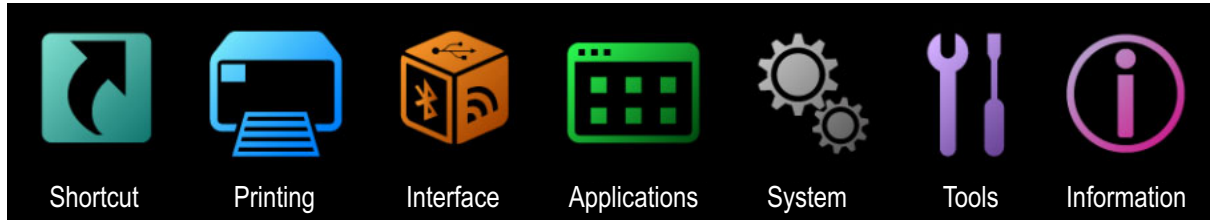

Menu	Description
Shortcut	Directly access frequently used settings.
Printing	Access the settings related to printing.
Interface	Access the settings related to the interfaces.
Applications	Access the settings related to the printer's command language.
System	Access the settings related to the display language, buzzer volume etc.
Tools	Access the test print, initialization and other settings.
Information	Access the printer information and guidance videos.

4.2.1 Changing to Settings Mode

The settings mode can be shown when no print jobs remain in the printer. Change the printer to settings mode according to the following procedure:

- 1 Press the **▶||** button in online mode.
The printer enters offline mode.



2 Press the **←** button.

The printer enters settings mode.

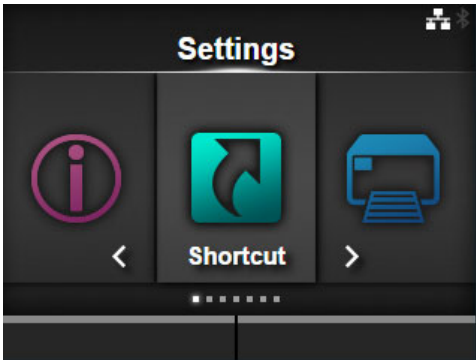

To exit the settings mode, press the **▶▶** button.

4.2.2 Log In to/Log Out of the Settings Mode

After entering the settings mode, you will be prompted with password if password is enabled (Refer to **Password Enable** in *System > Password*).

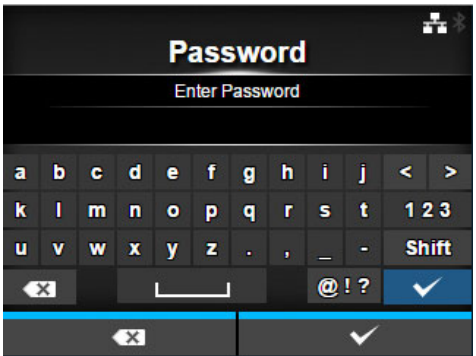

When you exit from the settings mode after a successful login, **LOG OUT** shows on the bottom left of the screen.

Press the left soft button if you want to log out immediately.

Password is required to enter the settings mode again.

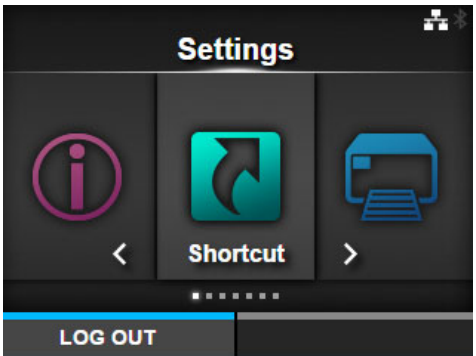

Note

With password enabled, if no button is pressed for about ten minutes after login, the login session will end automatically. Password is required to enter the settings mode again.

4.2.3 Item Selection

Select an item in settings mode according to the following procedure:

1 Select menu using the ◀/▶ buttons.

2 Press the ↵ button.

The item list shows.

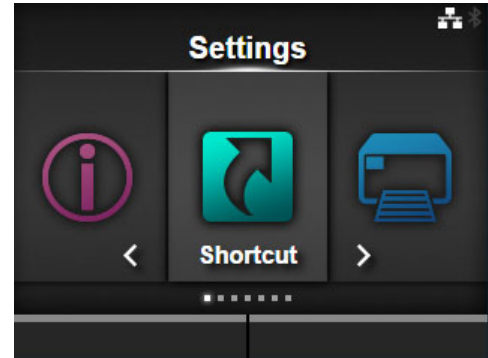

3 Select an item using the ▲/▼ buttons.

4 Press the ↵ button.

If the selected item is a setting item, the setting screen shows.

If the selected item is a command, the command will be executed.

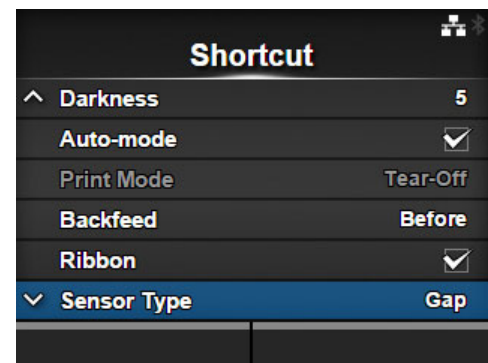

Items with a “>” indicated on the right side have more items in the next layer of the submenu.

Press the ▶ or ◀ button to show the next layer.

Similarly, select an item using the ▲/▼ and ↵ buttons.

Press the ↶ button to return to the previous screen.

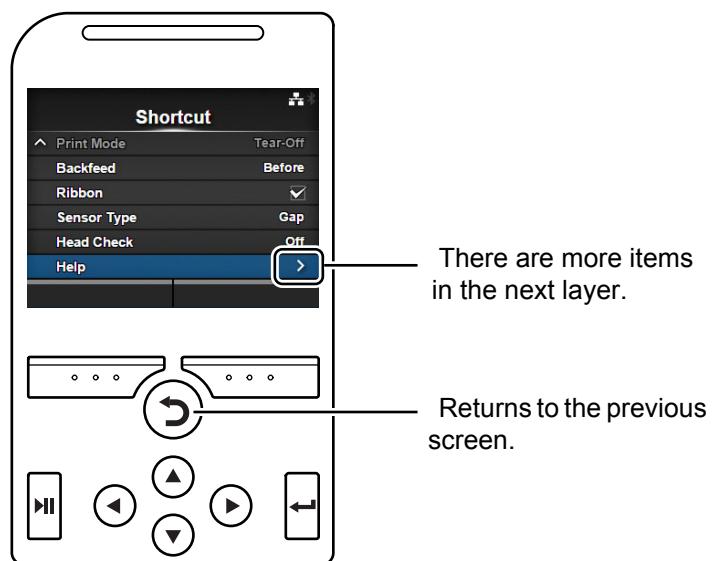

4.2.4 Setting Value Input or Selection

This section describes the character and number input on the setting screen and how to select an item from the list.

Note

You can also input characters and numbers from a USB keyboard by connecting it to the printer.

- **Character Input**

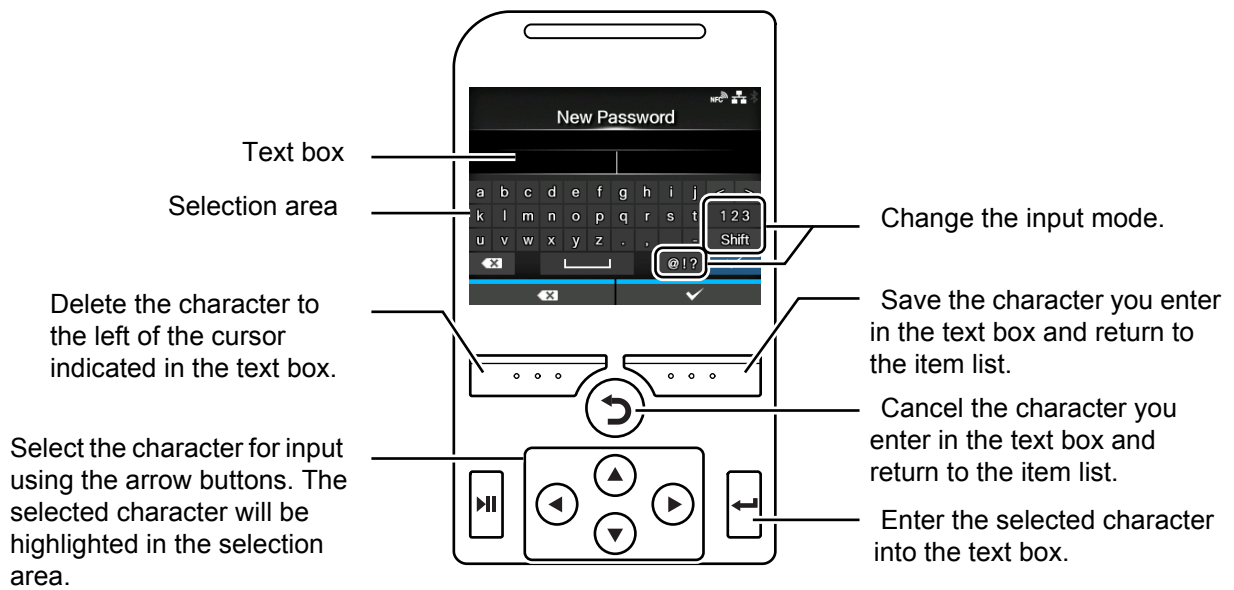

• **Numeric Input**

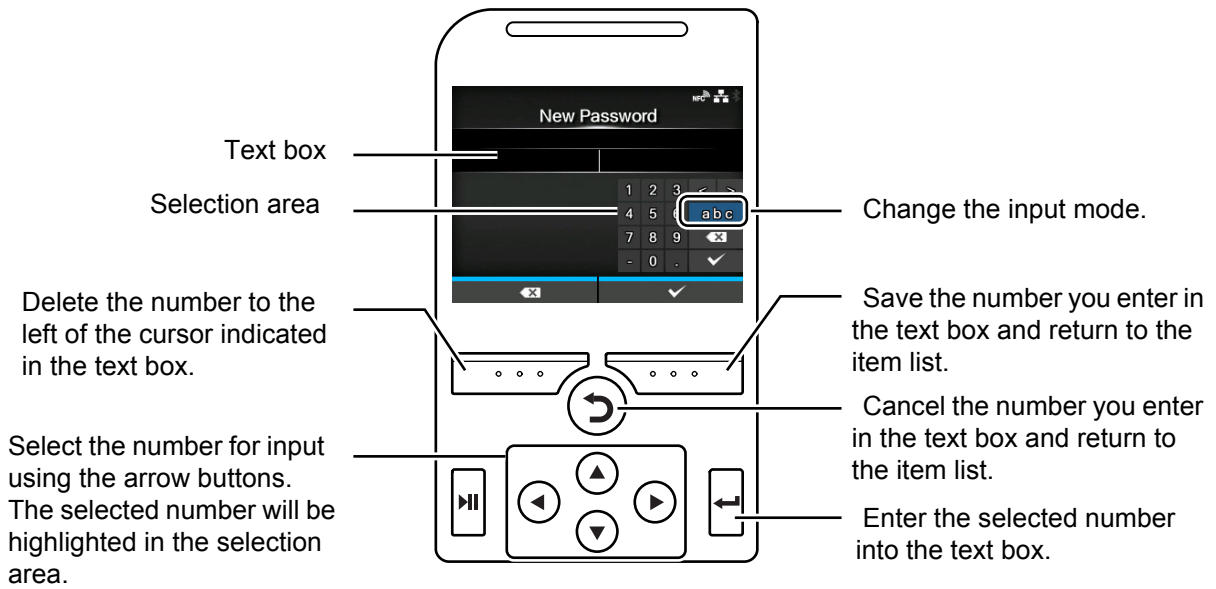

• **Selection from the list**

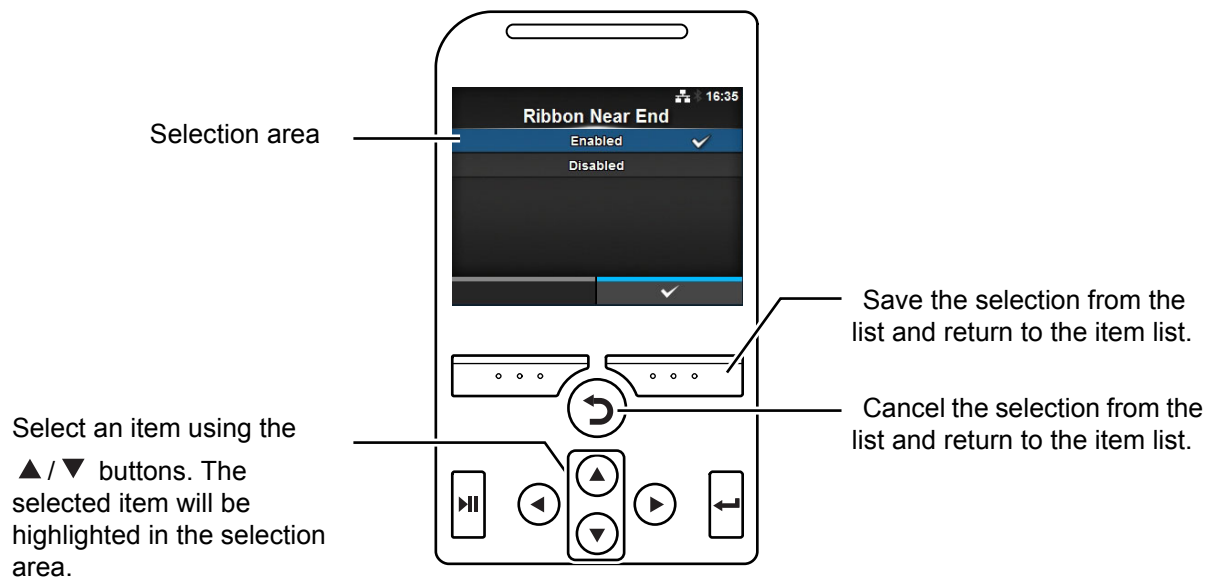

• Selection from the box

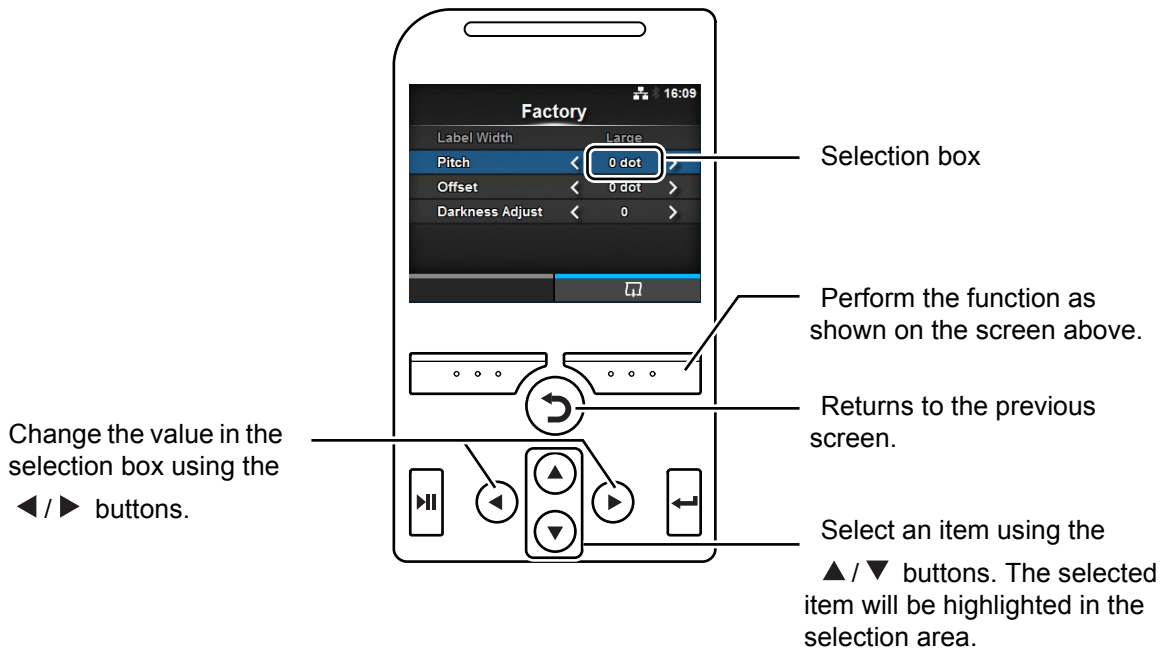

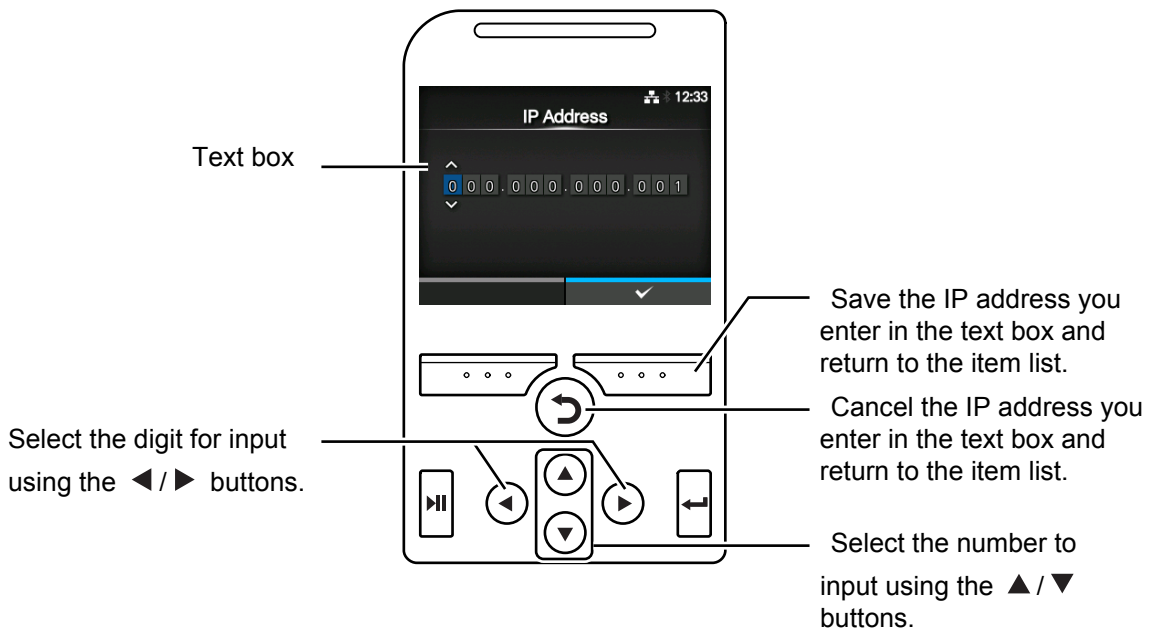

• Entering an IP address



4.3 Settings Menu Tree Structure

There are six main menus in Settings mode and each menu contains many layers of submenus. Frequently used settings are also listed in the Shortcut menu so that you can directly access them. The tables below outline the Settings menus tree structure. Refer to the tree structure to understand where information is located in the setting menus. Click on the items in blue to link directly to the details of the selected items.

 Shortcut	Shortcuts to frequently used settings
Adjustments	
Speed	
Darkness Range	
Darkness	
Auto-mode	
Print Mode	
Backfeed	
Ribbon	
Sensor Type	
Head Check	
Help	

 Printing		Submenus		
Label Length				
Label Width				
Auto Measure				
Ribbon				
Ribbon Near End				
Speed				
Sensor Type				
Auto-mode				
Print Mode				
Backfeed				
Eject Cut				
Darkness Range				
Darkness				
Imaging	Vertical			
	Horizontal			
Advanced	Calibrate	Auto-calibration		
		GAP Levels		
		GAP Slice Level		
		I-Mark Levels		
		I-Mark Slice Level		
	Head Check			
	Head Check Mode			
	Every Page			
	Check Media Size			
	Adjustments	Offset		
		Pitch		
		Darkness Adjust		
	Start Online			
	Feed After Error			
	Feed At Power On			
	Finisher Feed			
	Paper End			
	Head Base Position			
	Prioritize			
	Reprint			
Print End Position				
Label Near End				

 Interface		Submenus			
Network	Settings	LAN	IPv4	Mode	
				DHCP/Renew Lease	
				IP Address	
				Netmask	
				Gateway	
			DNS		
			IPv6	Mode	
				DHCP/Renew Lease	
				IP Address	
				Prefix Length	
				Gateway	
			DNS		
	Proxy	Enabled			
		Server			
		Exclude			
	Wi-Fi		IPv4	Mode	
				DHCP/Renew Lease	
				IP Address	
				Netmask	
				Gateway	
			DNS		
			IPv6	Mode	
				DHCP/Renew Lease	
				IP Address	
Prefix Length					
Gateway					
DNS					
Proxy			Enabled		
			Server		
			Exclude		
Wi-Fi Protected Setup			Button (PBC)		
			PIN		
Wi-Fi Direct			Device Name		
	Connect				
	Start Group				
	Remove Group				
	Disconnect				
	SSID				
	IP Address				
	Passphrase				
SSID					

 Interface		Submenus	
Network	Settings	Wi-Fi	Hidden SSID Mode Channel Security WEP Conf. Authentication Key Index Key #1 - Key #4 WPA Conf. WPA Authentication PSK EAP Conf. EAP Conf. EAP Mode Inner Method Username Password Anon. Outer ID Verify Server Cert. Private Key P/W PAC Auto Provisioning PAC P/W
	Services	Interface Ports Port1 Port2 Port3 Flow Control Multiple connections Legacy Status for Port 9100 BCC NTP Enable Error Time Server IP LPD Enable DNS Lookup FTP Enable FTP Timeout	

 Interface		Submenus																																							
		Network	Services	SNMP sysContact sysName sysLocation prtMarkerCounterUnit Agent <table border="1" style="width: 100%;"> <tr> <td rowspan="10">Enable</td> <td>Read-Only</td> <td>SNMP Version</td> </tr> <tr> <td></td> <td>Community</td> </tr> <tr> <td></td> <td>User</td> </tr> <tr> <td></td> <td>User Security</td> </tr> <tr> <td></td> <td>Authentication Protocol</td> </tr> <tr> <td></td> <td>Authentication Passphrase</td> </tr> <tr> <td></td> <td>Privacy Protocol</td> </tr> <tr> <td></td> <td>Privacy Passphrase</td> </tr> <tr> <td rowspan="6">Read-Write</td> <td>SNMP Version</td> </tr> <tr> <td>Community</td> </tr> <tr> <td>User</td> </tr> <tr> <td>User Security</td> </tr> <tr> <td>Authentication Protocol</td> </tr> <tr> <td>Authentication Passphrase</td> </tr> </table> Traps <table border="1" style="width: 100%;"> <tr> <td>Enable</td> </tr> <tr> <td>SNMP Version</td> </tr> <tr> <td>IP Version</td> </tr> <tr> <td>Destinations</td> </tr> <tr> <td>Destination 1</td> </tr> <tr> <td>Destination 2</td> </tr> <tr> <td>Destination 3</td> </tr> <tr> <td>Community</td> </tr> <tr> <td>User</td> </tr> <tr> <td>Engine ID</td> </tr> <tr> <td>Security</td> </tr> <tr> <td>Authentication Protocol</td> </tr> <tr> <td>Authentication Passphrase</td> </tr> <tr> <td>Privacy Protocol</td> </tr> <tr> <td>Privacy Passphrase</td> </tr> </table>	Enable	Read-Only	SNMP Version		Community		User		User Security		Authentication Protocol		Authentication Passphrase		Privacy Protocol		Privacy Passphrase	Read-Write	SNMP Version	Community	User	User Security	Authentication Protocol	Authentication Passphrase	Enable	SNMP Version	IP Version	Destinations	Destination 1	Destination 2	Destination 3	Community	User	Engine ID	Security	Authentication Protocol	Authentication Passphrase
Enable	Read-Only	SNMP Version																																							
		Community																																							
		User																																							
		User Security																																							
		Authentication Protocol																																							
		Authentication Passphrase																																							
		Privacy Protocol																																							
		Privacy Passphrase																																							
	Read-Write	SNMP Version																																							
		Community																																							
User																																									
User Security																																									
Authentication Protocol																																									
Authentication Passphrase																																									
Enable																																									
SNMP Version																																									
IP Version																																									
Destinations																																									
Destination 1																																									
Destination 2																																									
Destination 3																																									
Community																																									
User																																									
Engine ID																																									
Security																																									
Authentication Protocol																																									
Authentication Passphrase																																									
Privacy Protocol																																									
Privacy Passphrase																																									
	Advanced	ARP Announcement	Additional Periodic																																						

 Interface		Submenus		
IEEE1284	Flow Control			
	BCC			
RS-232C	Interface			
	Baudrate			
	Parameters			
	Flow Control			
	BCC			
USB	Flow Control			
	BCC			
Bluetooth	Enable			
	Name			
	PIN Code			
	BD Address			
	Firm Version			
	Host BD Addr			
	Authentication			
	ISI			
	ISW			
	PSI			
	PSW			
	CRC Mode			
	Flow Control			
	NFC	I/F Enable		
Ignore CR/LF				
Ignore CAN/DLE				
External I/O	Enable			
	Signals	EXT 9PIN		
		EXT Mode		
		Inputs	Start Print	
			Reprint	
		Outputs	Paper End	
			Ribbon End	
			Machine Error	
			Print Done	
			Qty/Offline	
Ribbon Near End				
Dispenser				
Label Near End				
EXT I/O Re-print				

	Interface	Submenus	
	RFID (CL4NX only)	Antenna Pitch	
Write Power			
Read Power			
Tag Offset			
Reader Model			
Reader Version			
View		Memory Bank	
Retry Mode			
Retries			
Mark bad tags			
MCS		MCS	
Chip Manufacturer			
Pre-Encoded Tag			
Assign Prefix			
MCS Prefix Digit			
Input Prefix			
Non-RFID Warning			
Log RFID Data			
Data To Record			
Output Error Mode			
Pulse Length			
Counters	Lifetime	Count Success	
		Count Failure	
		Count Total	
		User	
		Count Success	
		Count Failure	
		Count Total	

 Applications	Submenus		
Protocol			
SBPL	Show Error		
	Standard Code		
	Orientation		
	Font Settings	Zero Slash	
		Kanji	Kanji Set
			Character Code
			Kanji Style
		Proportional	
		Code Page	
		€	
	Compatible	M-8400 Compatibility	
		CODE128(C) Zero Fill	
		Kanji Command	
		Call Font/Logo	
ENQ Reply Delay			
ENQ Reply Cycle			
SZPL	Label	Shift	
		Top	
	Caret		
	Delimiter		
	Tilde		
Clock Format			
SIPL	Font Settings	Code Page	
		New Font Encoding	
		c20 Proportional Pitch	
		Zero Slash	
	Format Save		
STCL	Command Head	Control Code	
		1st Byte Code	
		2nd Byte Code	
		3rd Byte Code	
	Font Settings	Zero Slash	
		€	
		Code Page	
	Half-width Symbol		
	Rotation		
Ignore Paper Size Command			

 Applications		Submenus		
SDPL	Control Code	Code Type		
		SOH		
		STX		
		CR		
		CNTBY		
	Label Rotation			
	SOP Emulation			
	Compatible Mode	TTF		
		Graphics		
	Right-to-Left print			
	Prioritize	Format Attribute		
		Pause Mode		
		1 Byte Codepage		
		SDPL Measure Unit		
		Scalable Font Style		
		Darkness		
		Factory Offset		
		Speed		
	Format Attribute			
	Pause Mode			
	1 Byte Codepage			
SDPL Measure Unit				
Scalable Font Style	Bold			
	Italic			
SEPL	Home Reference	Horz. Offset		
		Vert. Offset		
Memory Device				
Sim. 300 DPI Head				
AEP	Enable			
	Start Application			
	Label Rotation			

 System	Submenus			
Regional	Messages			
	USB Keyboard			
	Locale			
	Unit			
	Time			
	Date			
	Time Zone	Region	City	
Notifications	Clean Printhead	Clean Printhead		
		Cleaning Interval		
		Clean Counter		
	Change Printhead	Change Printhead		
		Printhead Interval		
		Printhead Count		
	Change Cutter	Change Cutter		
		Cutter Life		
		Cutter Count		
	Change Platen	Change Platen		
		Platen Interval		
		Platen Count		
Sound	Error Sound			
Energy Saving	Sleep Timeout			
LCD Brightness				
Show Total Count				
Password	Password Enable			
	Install Security			
	NFC Security			
	Change Password	admin		
		manager		
level1				
rfid				
Start on AC				

 Tools		Submenus	
Test Print	Factory	Label Width	
		Pitch	
		Offset	
		Darkness Adjust	
	Configure List	Label Width	
		Label Length	
		Pitch	
		Offset	
		Darkness Adjust	
	Configure QR	Label Width	
		Label Length	
		Pitch	
		Offset	
		Darkness Adjust	
	Paper Sensor	Label Width	
		Label Length	
Pitch			
Offset			
Darkness Adjust			
HEX-Dump	Hex Dump Mode		
	Buffer Dump		
	Log Files	Copy	
		Remove	
Print			
Reset	Select	Data	
		Data & Settings	
		Settings	
Profiles	Delete		
	Load		
	Save		
	Start with		
Service			
Factory			
Certificates	HTTPS		
	Wi-Fi Root CA		
	Wi-Fi Client		
	Wi-Fi Private Key		
	EAP-FAST PAC File		

 Tools	Submenus		
	Barcode Checker	Test	Reader Name
		Settings	
			Mode
			Start Position
			VOID Print
			Retry Count
			Host Notification
			Logs
			Remove
Clone			
Startup Guide			

 Information	Submenus		
	Help	Install Paper Roll Fanfold	Standard Cutter Linerless (CL4NX only) Dispenser Dispenser with Rewinder Standard Cutter
	Install Ribbon		
	Replace Paper Roll Fanfold	Standard Cutter Linerless (CL4NX only) Dispenser Dispenser with Rewinder Standard Cutter	
	Replace Ribbon		
	Replace Head		
	Replace Platen		
	Cleaning		
	Build Version	Name Date Checksum Kernel Version Boot Version	
		Disks	
		Warp!!-mode	
		Date	
Applications			
Installation Log	RPM Log System Restore		
Print Module	Boot	Name	
		Release Date	
		Checksum	
	Main	Name	
		Release Date	
		Checksum	
Counters	Head	Life	
		Head 1	
		Head 2	
		Head 3	
	Cutter		
IPv4 Address			
IPv6 Address			

 Information	Submenus	
	LAN MAC	
	Wi-Fi MAC	
	Wi-Fi Region	
	Wi-Fi Status	
	Wi-Fi Direct	SSID
		Role
		Device Address
		IP Address
		Passphrase
Wi-Fi Versions		

4.4 Details of the Settings Menu Screen

4.4.1 Shortcut Menu

Frequently used settings are listed in the **Shortcut** menu.

Shortcut		
1	Adjustments	Correct the offset, print position and print darkness.
2	Speed	Set the print speed.
3	Darkness Range	Set the range of the print darkness.
4	Darkness	Set the print darkness.
5	Auto-mode	Automatically set the print mode.
6	Print Mode	Manually set the print mode.
7	Backfeed	Set the backfeed operation.
8	Ribbon	Set whether to print using a ribbon or direct thermal media.
9	Sensor Type	Set the media sensor type.
10	Head Check	Check if there is a broken element of the print head.
11	Help	Shows the guidance video.

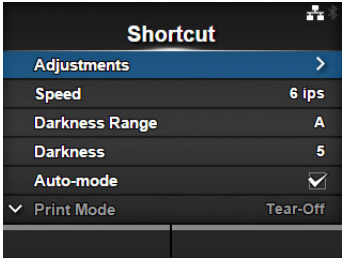

The screenshot shows a dark-themed menu titled "Shortcut" with a list of settings. The "Adjustments" option is highlighted with a blue bar and a right-pointing arrow. Other settings include "Speed" at 6 ips, "Darkness Range" set to A, "Darkness" set to 5, "Auto-mode" which is checked with a white checkmark, and "Print Mode" set to Tear-Off.

4.4.2 Printing Menu

The following settings are available in the **Printing** menu:

Printing		
1	Label Length	Set the length of the media.
2	Label Width	Set the width of the media.
3	Auto Measure	Automatically measure the length of the media.
4	Ribbon	Set whether to print using a ribbon or direct thermal media.
5	Ribbon Near End	Enable or disable the warning when the ribbon is about to run out. *Shows only if you have selected Use Ribbon in the Ribbon menu.
6	Speed	Set the print speed.
7	Sensor Type	Set the media sensor type.
8	Auto-mode	Automatically set the print mode.
9	Print Mode	Manually set the print mode.
10	Backfeed	Set the backfeed operation.
11	Eject Cut	Set the time from the print completion until the print cut. *Shows only if you have selected Cut & Print in the Print Mode menu.
12	Darkness Range	Set the range of the print darkness.
13	Darkness	Set the print darkness.
14	Imaging	Set the print reference position in the vertical and horizontal directions.
15	Advanced	Set the sensor operation and print motion.

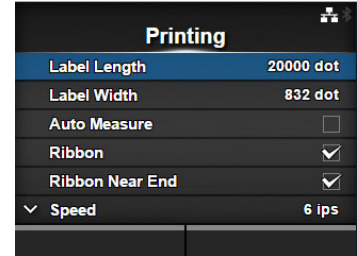

Label Length

Printing > Label Length

Set the length of the media.
The setting range varies depending on the print resolution of the printer.
The setting range of the label length is as follows:

<CL4NX>

- 203 dpi: 1 to 20000 dots
- 305 dpi: 1 to 18000 dots
- 609 dpi: 1 to 9600 dots

<CL6NX>

- 203 dpi: 1 to 20000 dots
- 305 dpi: 1 to 18000 dots

Note

Set the label size to a value that includes the liner.

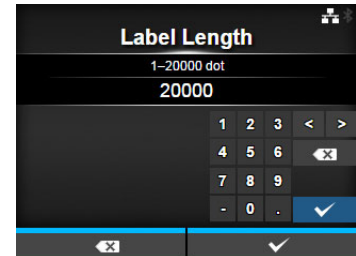

Label Width

Printing > Label Width

Set the width of the media.
The setting range varies depending on the print resolution of the printer.
The setting range of the label width is as follows:

<CL4NX>

- 203 dpi: 1 to 832 dots
- 305 dpi: 1 to 1248 dots
- 609 dpi: 1 to 2496 dots

<CL6NX>

if Head Base Position is Standard

- 203 dpi: 1 to 1216 dots
- 305 dpi: 1 to 1984 dots

if Head Base Position is Left-justify

- 203 dpi: 1 to 1340 dots
- 305 dpi: 1 to 2010 dots

Note

Set the label size to a value that includes the liner.

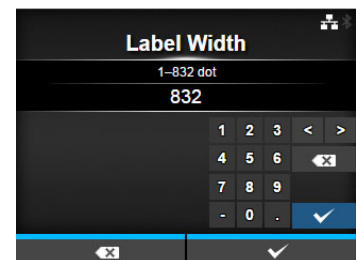

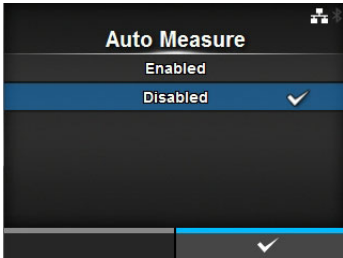
Auto Measure	
<p><i>Printing > Auto Measure</i></p> <p>The printer automatically measures the length of the media. The measured length of the media will be automatically saved in Label Length. The Auto Measure function can be performed when Sensor Type is set to Gap or I-Mark. The setting procedure of the label length using the Auto Measure function is as follows:</p> <ol style="list-style-type: none"> 1. Load the media. 2. Set Auto Measure to Enabled. 3. Press the ▶ button or ↶ button to show the online or offline screen. 4. Open the print head. (Head Open error occurs) 5. Close the print head. (Returns to offline screen) 6. When you press the ▶ button, the printer feeds two pieces of label and measures the label length. 7. The measured label length will be saved in Label Length. <hr/> <p>Note When you have set Auto Measure to Enabled, this function executes when the printer powers on.</p>	

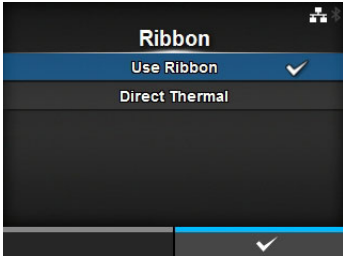
Ribbon	
<p><i>Printing > Ribbon</i></p> <p>Set whether to print using a ribbon or direct thermal media. The options are as follows:</p> <ul style="list-style-type: none"> • Use Ribbon: Print with a ribbon. • Direct Thermal: Print using direct thermal media. 	

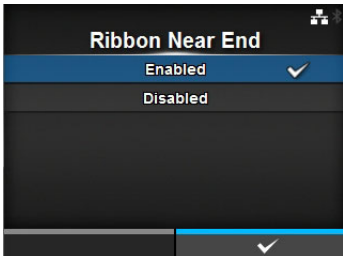
Ribbon Near End	
<p><i>Printing > Ribbon Near End</i></p> <p>Show or do not show the warning icon when the ribbon is about to run out. Shows only if you have selected Use Ribbon in the Ribbon menu. The options are as follows:</p> <ul style="list-style-type: none"> • Enabled: Show the warning icon. • Disabled: Do not show the warning icon. <hr/> <p>Note The warning icon shows in the status bar on the upper part of the screen.</p>	

Speed

Printing > Speed

The setting range varies depending on the print resolution of the printer.
The setting range of the print speed is as follows:

<CL4NX>

- 203 dpi: 2 to 10 ips (inches/sec)
- 305 dpi: 2 to 8 ips (inches/sec)
- 609 dpi: 2 to 6 ips (inches/sec)

If the optional linerless cutter kit is installed, the setting range will be from 2 to 6 ips (inches/sec) regardless of the print resolution of the printer.

If Speed is set to 7 ips and above, it will change to 4 ips after the optional linerless cutter kit is installed.

<CL6NX>

- 203 dpi: 2 to 10 ips (inches/sec)
- 305 dpi: 2 to 8 ips (inches/sec)

Note

Setting the print speed to a level that is too fast may affect the print quality.

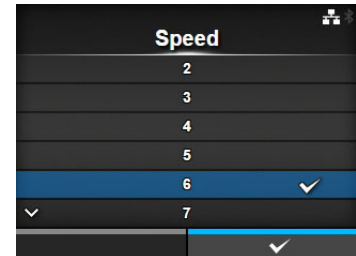

Sensor Type

Printing > Sensor Type

Set the type of sensor for sensing the media.

The options are as follows:

- **None**: Disable the media sensor.
- **Gap**: Use the transmissive type sensor.
- **I-Mark**: Use the reflective type sensor.

If you have selected **Tear-Off**, **Dispenser** or **Cut & Print** in **Print Mode**, only **Gap** and **I-Mark** will be available in the **Sensor Type** menu.

If you have selected **Linerless** in **Print Mode** (CL4NX only), only **None** and **I-Mark** will be available in the **Sensor Type** menu.

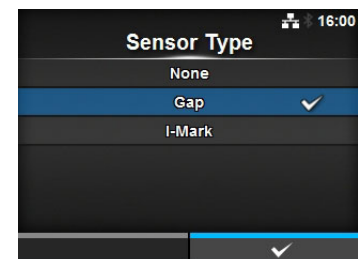

Auto-mode

Printing > Auto-mode

When using Auto-mode, the print mode changes automatically according to the status of the installed option unit.

The options are as follows:

- **Enabled:** The print mode changes automatically.
- **Disabled:** The print mode changes according to the setting of the **Print Mode**.

Operate in cutter mode if you have installed the optional cutter unit.

Operate in dispenser mode if you have installed the optional dispenser unit.

Operate in linerless mode if you have installed the optional linerless cutter kit (CL4NX only).

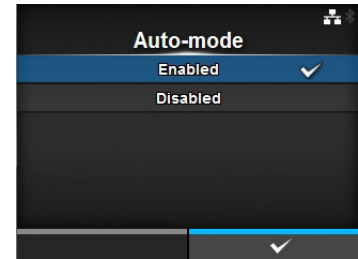

Print Mode

Printing > Print Mode

Set the print mode.

The options are as follows:

- **Continuous**: Print the specified number of media. The media remains in position for printing at all times.
- **Tear-Off**: After printing the specified number of media, the printer feeds the last printed media so that it is fully extended out of the printer's front for removal. After printing, tear off the media manually.
- **Cutter**: Cut each media while printing the specified number of media. You can specify this option only if you have installed the cutter unit.
- **Cut & Print**: Allows you to continuously print and cut at the specified media repeat. If no print data is received within the period specified for **Eject Cut**, the printer will feed the media to the cut position and cut the last printed media. You can specify this option only if you have installed the cutter unit.
- **Dispenser**: Peel the liner from the printed label as it is advanced to the printer's front. Once the printed label has been removed from the printer for application, the next label will retract and position itself for printing. You can specify this option only if you have installed the dispenser unit.
- **Linerless (CL4NX only)**: Cut each label while printing the specified number of labels. You can specify this option only if you have installed the linerless cutter kit.

<CL4NX>

If no option is installed, **Continuous** and **Tear-Off** are available in the **Print Mode** menu.

If the optional cutter unit is installed, **Continuous**, **Tear-Off**, **Cutter** and **Cut & Print** are available in the **Print Mode** menu.

If the optional dispenser unit is installed, **Continuous**, **Tear-Off** and **Dispenser** are available in the **Print Mode** menu.

If the optional linerless cutter kit is installed, only **Linerless** is available in the **Print Mode** menu.

<CL6NX>

If no option is installed, **Continuous** and **Tear-Off** are available in the **Print Mode** menu.

If the optional cutter unit is installed, **Continuous**, **Tear-Off**, **Cutter** and **Cut & Print** are available in the **Print Mode** menu.

If the optional dispenser unit is installed, **Continuous**, **Tear-Off** and **Dispenser** are available in the **Print Mode** menu.

Note

You cannot set the **Print Mode** if **Auto-mode** is **Enabled**.

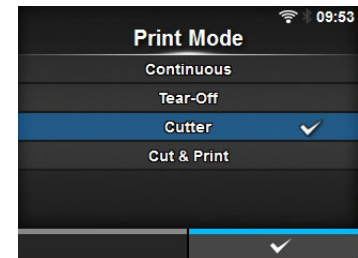

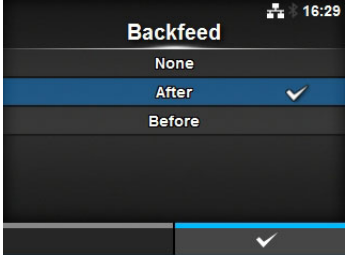
Backfeed	
<p><i>Printing > Backfeed</i></p> <p>Backfeed is applicable only when the print mode is set to tear-off mode, cutter mode, cut & print mode, dispenser mode or linerless mode (CL4NX only).</p> <p>The options are as follows:</p> <ul style="list-style-type: none"> • None: Do not backfeed. • After: After cut, backfeed the front part of the next media to the print head position. For dispenser mode, backfeed the front part of the next label after dispensing the label. • Before: Before printing, backfeed the front part of the media to the print head position. <p>If you have selected Tear-Off or Linerless (CL4NX only) in Print Mode, only Before is available in the Backfeed menu.</p> <p>If you have selected Cut & Print in Print Mode, only After is available in the Backfeed menu.</p>	

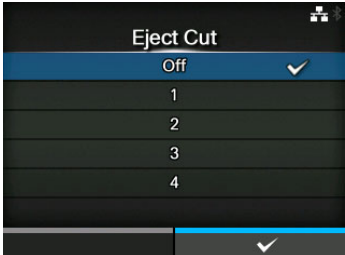
Eject Cut	
<p><i>Printing > Eject Cut</i></p> <p>Set the Eject cut motion for the last printed media. Cut the last media after the specified timing.</p> <p>Shows only when you have selected Cut & Print in the Print Mode menu. The setting range is Off, or from 1 to 4 (sec).</p>	

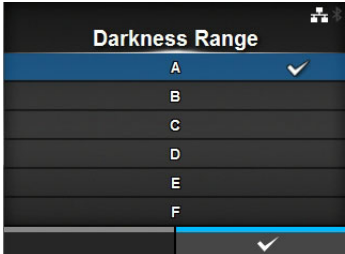
Darkness Range	
<p><i>Printing > Darkness Range</i></p> <p>Set the range of the print darkness.</p> <p>The darkness range affects the print darkness.</p> <p>The options are as follows: A, B, C, D, E, F</p> <p>*The normal setting is A. You can also select B to F but the print darkness does not change.</p>	

Darkness

Printing > Darkness

Specify the print darkness from ten steps.
The setting range is from 1 to 10. 1 is the lightest and 10 is the darkest.

To further fine tune the print darkness, set the items in **Printing > Advanced > Adjustments > Darkness Adjust**.

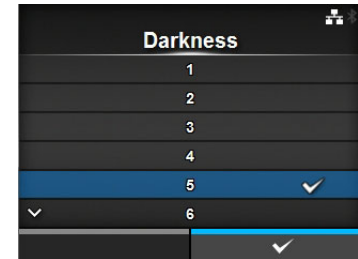

Imaging

Printing > Imaging

Set the print reference position in the vertical and horizontal directions.
The setting items are as follows:

1	Vertical	Adjust the print position in the vertical (feed) direction.
2	Horizontal	Adjust the print position in the horizontal direction.

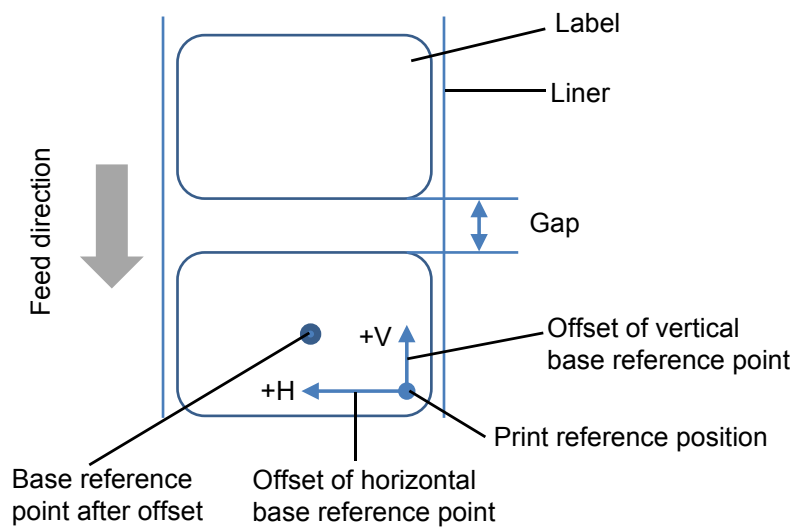
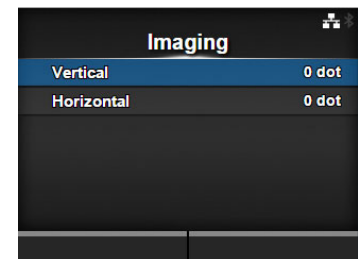

Vertical

Printing > Imaging > Vertical

Set the print position in the vertical direction.
Set the offset value '+' from the print reference position to move the print position opposite the feed direction and value '-' to move the print position in the feed direction.

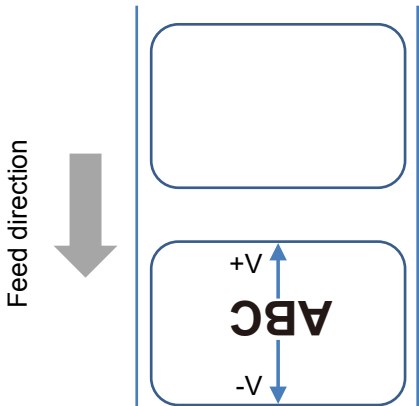

The setting range is from -792 to +792 dots.

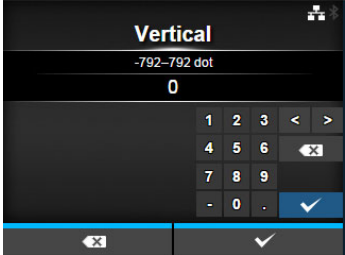

Horizontal

Printing > Imaging > Horizontal

Set the print position in the horizontal direction.
Set the offset value '+' from the print reference position to move to the left side and value '-' to move to the right side of the printer (when facing the front of the printer).

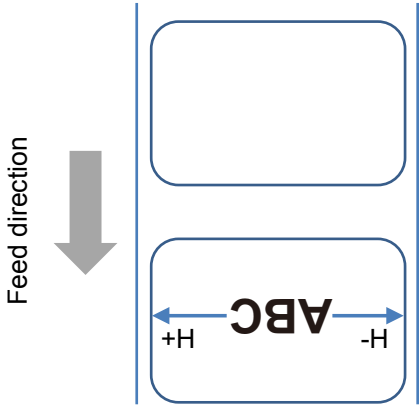

The setting range is from -792 to +792 dots.

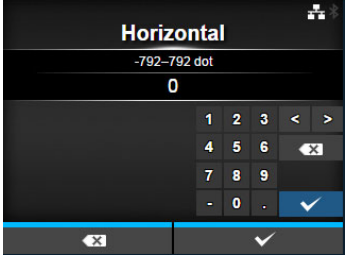

Advanced		
<p><i>Printing > Advanced</i></p> <p>Set detailed sensor operation and print motion. The setting items are as follows:</p>		
1	Calibrate	Adjust the media sensor.
2	Head Check	Check if there is a broken element of the print head.
3	Head Check Mode	Set the mode for head check. *Shows only if you have selected All or Barcode in the Head Check menu.
4	Every Page	Set the interval for head check. *Shows only if you have selected Every Page in the Head Check Mode menu.
5	Check Media Size	Enable or disable media size check. *Shows only if you have selected Gap or I-Mark in the Sensor Type menu.
6	Adjustments	Correct the offset, print position and print darkness.
7	Start Online	Set whether to power on the printer in online mode.
8	Feed After Error	Set whether to automatically feed the media when recovering from an error.
9	Feed At Power On	Set whether to automatically feed the media at power on.
10	Finisher Feed	Set the length to feed after printing.
11	Paper End	Select the sensor for sensing the paper end.
12	Head Base Position	Set the edge position for printing.
13	Prioritize	Select the prioritized setting.
14	Reprint	Enable or disable the reprint function.
15	Print End Position	Adjust the media stop position or cut position when Sensor Type is set to None .
16	Label Near End	Enable or disable the warning when the media is about to run out. *This feature is supported on printers from serial number 6B~ and above. Although this setting shows on printers with serial number 6A~ or below, it is not supported.

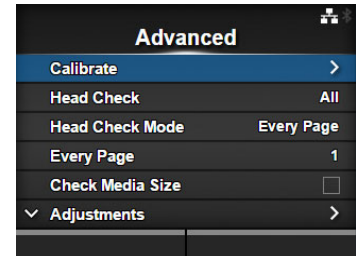

Calibrate		
<p><i>Printing > Advanced > Calibrate</i></p> <p>Adjust the media sensor level. In instances of media detection malfunction, adjust the media sensor level (Gap and I-mark sensor). The setting items are as follows:</p>		
1	Auto-calibration	Automatically adjust the sensor level. *Does not show if you have installed the optional linerless cutter kit (CL4NX only).
2	GAP Levels	Manually set the Gap sensor level.
3	GAP Slice Level	Manually set the Gap sensor slice level.
4	I-Mark Levels	Manually set the I-mark sensor level.
5	I-Mark Slice Level	Manually set the I-mark sensor slice level.

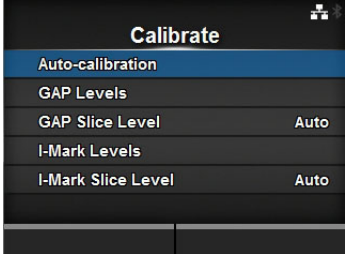

Auto-calibration	
<p><i>Printing > Advanced > Calibrate > Auto-calibration</i></p> <p>Perform the auto-calibration for the selected media sensor. Auto-calibration is not available if you have installed the optional linerless cutter kit (CL4NX only).</p> <ul style="list-style-type: none"> • Gap + I-Mark: Perform the adjustment for both the Gap sensor and I-mark sensor. • Gap: Perform the adjustment for the Gap sensor. • I-Mark: Perform the adjustment for the I-mark sensor. <p>Procedure:</p> <ol style="list-style-type: none"> 1. Push the head lock lever towards the rear to unlock the print head. 2. Pass the media below the media sensor guide. If you are using labels, remove the label from the liner. Align it so that the media sensor does not sense the I-mark (black mark). 3. Press the print head down until the head lock lever is locked. To get the correct adjustment result, adjust after you have locked the print head. 4. Press the ▲/▼ buttons to select the type of sensor to be adjusted. 5. Press the right soft button or ← button. 6. When the confirmation screen appears, press the right soft button to start the sensor adjustment. 7. The sensor adjustment result shows. To exit the adjustment, press the right soft button. 8. Set to offline mode. Press the right soft button to confirm that the media feeds correctly. <hr/> <p>Note If the media does not feed correctly after Auto-calibration, contact your SATO reseller or technical support center.</p>	



GAP Levels

Printing > Advanced > Calibrate > GAP Levels

Manually set the Gap sensor level.

The setting procedure is as follows:

First, adjust the “Low” level (voltage) of the Gap sensor.

1. Remove the label from the liner.
2. Pass the liner through the media sensor. Align it so that the media sensor does not sense the I-mark (black mark).
3. Close the print head. To get the correct adjustment result, adjust after you have closed the print head.
4. Select the **GAP Levels** in the **Calibrate** menu and press the **←** button.
5. Press the **▲/▼** buttons to change the **Emit** value until the **Sensor** value is below 0.5 (V). Set the **Emit** value as low as possible.
6. If the **Sensor** value does not decrease below 0.5 after you changed the **Emit** value, press the **◀/▶** buttons to change the **Receive** value.
7. Take a note of the **Sensor** value from the above procedure. This is the “Low” level value for the Gap sensor.

Next, check the “High” level (voltage) of the Gap sensor as follows:

8. Pass the media (attached with liner) between the media sensors. Align it so that the media sensor does not sense the I-mark (black mark).
9. Close the print head.
10. Check the **Sensor** value.
If the value is 1.0 (V) higher than the “Low” level value you have recorded, then this is the “High” level value for the Gap sensor.
If the difference between the “High” and the “Low” levels is less than 1.0, adjust the **Emit** and **Receive** values so that the difference is more than 1.0, or perform the adjustments again from step 1.
The standard values for the “High” and “Low” levels for the Gap sensor are as follows:
 - Low (with only liner) ≤ 0.5 (V)
 - High (media attached with liner) - Low ≥ 1.0 (V)
11. If both “High” and “Low” levels comply with the standard value, press the right soft button to confirm the value.

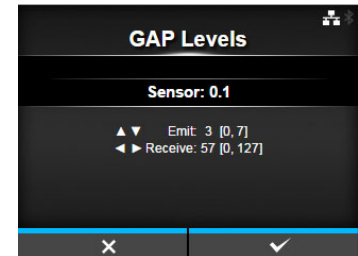

GAP Slice Level

Printing > Advanced > Calibrate > GAP Slice Level

Set the Gap sensor slice level.

The setting procedure is as follows:

1. Use the following formula to calculate the slice level.
[(High level - Low level) x 0.3 + Low level = slice level]
2. Select the **GAP Slice Level** in the **Calibrate** menu and press the **←** button.
3. Press the **▲/▼** buttons to change the **Slice level** value. Set the **Slice level** to the level calculated in step 1.
4. Press the right soft button to confirm the value.

Note

If you set the **Slice level** to 0.0 (V), the printer sets the slice level automatically.

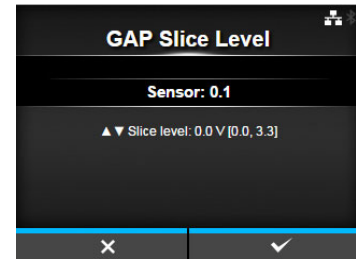

I-Mark Levels

Printing > Advanced > Calibrate > I-Mark Levels

Manually set the I-mark sensor level.

The setting procedure is as follows:





First, adjust the “Low” level (voltage) of the I-mark sensor.

1. Pass the media (attached with liner) between the media sensors. Align it so that the media sensor does not sense the I-mark (black mark).
2. Close the print head. To get the correct adjustment result, adjust after you have closed the print head.
3. Select the **I-Mark Levels** in the **Calibrate** menu and press the **←** button.
4. Press the **▲/▼** buttons to change the **Emit** value until the **Sensor** value is below 0.5 (V). Set the **Emit** value as low as possible.
5. If the **Sensor** value does not decrease below 0.5 after you changed the **Emit** value, press the **◀/▶** buttons to change the **Receive** value.
6. Take a note of the **Sensor** value from the above procedure. This is the “Low” level value for the I-mark sensor.

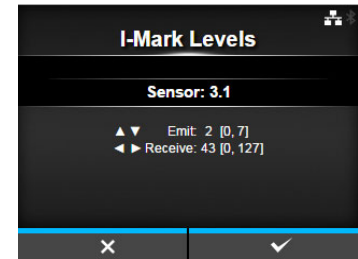
Next, check the “High” level (voltage) of the I-mark sensor as follows:

7. Pass the media between the media sensors so that the media sensor can sense the I-mark (black mark).
8. Close the print head.
9. Check the **Sensor** value.
If the value is 1.0 (V) higher than the “Low” level value you have recorded, then this is the “High” level value for the I-mark sensor.
If the difference between the “High” and the “Low” levels is less than 1.0, adjust the **Emit** and **Receive** values so that the difference is more than 1.0, or perform the adjustments again from step 1.
The standard values for the “High” and “Low” levels for the I-mark sensor are as follows:
 - Low (without I-mark) ≤ 0.5 (V)
 - High (with I-mark) - Low ≥ 1.0 (V)
10. If both “High” and “Low” levels comply with the standard value, press the right soft button to confirm the value.

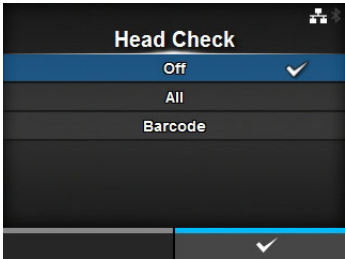

I-Mark Slice Level	
<p><i>Printing > Advanced > Calibrate > I-Mark Slice Level</i></p> <p>Set the I-mark sensor slice level. The setting procedure is as follows:</p> <ol style="list-style-type: none"> 1. Use the following formula to calculate the slice level. [(High level - Low level) x 0.7 + Low level = slice level] 2. Select the I-Mark Slice Level in the Calibrate menu and press the  button. 3. Press the  /  buttons to change the Slice level value. Set the Slice level to the slice level calculated in step 1. 4. Press the right soft button to confirm the value. <hr/> <p>Note If you set the Slice level to 0.0 (V), the printer sets the level automatically.</p>	

Head Check	
<p><i>Printing > Advanced > Head Check</i></p> <p>Automatically check if there is a broken element of the print head. The options are as follows:</p> <ul style="list-style-type: none"> • Off: Head Check disabled. • All: Check the entire print area. • Barcode: Check only the area for printing a barcode. Head check is not applicable for barcodes printed as graphic data. <hr/> <p>CAUTION Head check is a reference for checking for a broken element of the print head. This function does not guarantee barcode readability.</p>	

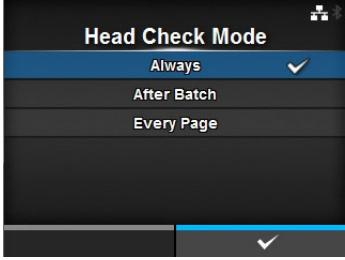
Head Check Mode	
<p><i>Printing > Advanced > Head Check Mode</i></p> <p>Set the method for head check. Shows only if you have selected All or Barcode in the Head Check menu. The options are as follows:</p> <ul style="list-style-type: none"> • Always: Perform the head check for every item. • After Batch: The head check occurs before starting to print and when printing is stopped. If backfeed is applicable, the head check occurs before starting to print, when stopping to print and during the backfeed. • Every Page: Perform the head check for each specified number of media. 	

Every Page

Printing > Advanced > Every Page

Specify the number of media between each head check.
Shows only if you have selected **Every Page** in the **Head Check Mode** menu.
The setting range is from 1 to 999999.

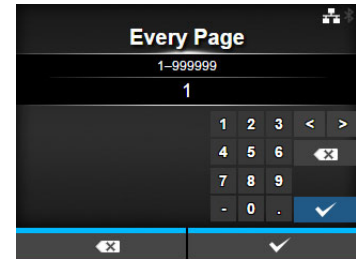

Check Media Size

Printing > Advanced > Check Media Size

Enable or disable media size check.
Media size check is a function to detect a **Media Error** when you load a media with a length longer than the media size specified by command, or if you have specified print data larger than the loaded media length.
Shows only if you have selected **Gap** or **I-Mark** in the **Sensor Type** menu.
The options are as follows:

- **Enabled**: Enable media size check.
- **Disabled**: Disable media size check.

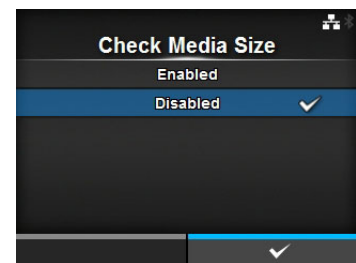

Adjustments

Printing > Advanced > Adjustments

Correct the offset position, print position and print darkness.
The setting items are as follows:

1	Offset	Adjusts the backfeed/stop position for Tear-off/Cut/Dispense operation.
2	Pitch	Adjusts the leading edge of media position thus effects the vertical print position placement.
3	Darkness Adjust	Fine tune the print darkness.

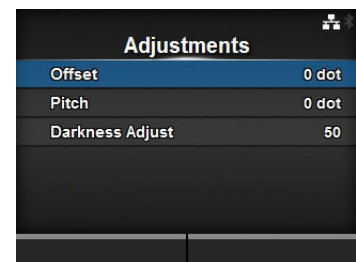

Offset

Printing > Advanced > Adjustments > Offset

Correct the offset position.
 Offset adjusts the backfeed/stop position for Tear-off/Cut/Dispense operation.
 Set the offset value '+' to move the stop position opposite the feed direction and value '-' to move the stop position in the feed direction.
 The setting range varies depending on the print resolution of the printer.
 The setting range is as follows:

<CL4NX>

- 203 dpi: -30 to 0 to 30 dots
- 305 dpi: -45 to 0 to 45 dots
- 609 dpi: -90 to 0 to 90 dots

<CL6NX>

- 203 dpi: -30 to 0 to 30 dots
- 305 dpi: -45 to 0 to 45 dots

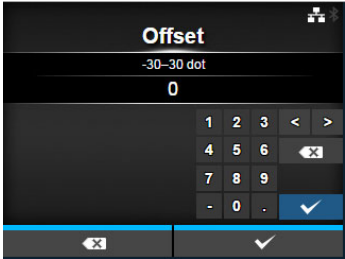

Pitch

Printing > Advanced > Adjustments > Pitch

Pitch adjusts the leading edge of media position thus effects the vertical print position placement.
 Set the offset value '+' to move the print position opposite the feed direction and value '-' to move the print position in the feed direction.

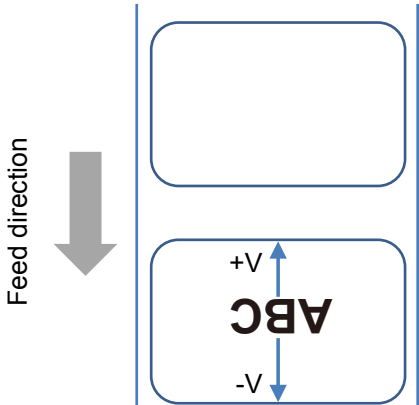

The setting range varies depending on the print resolution of the printer.
 The setting range is as follows:

<CL4NX>

- 203 dpi: -30 to 0 to 30 dots
- 305 dpi: -45 to 0 to 45 dots
- 609 dpi: -90 to 0 to 90 dots

<CL6NX>

- 203 dpi: -30 to 0 to 30 dots
- 305 dpi: -45 to 0 to 45 dots

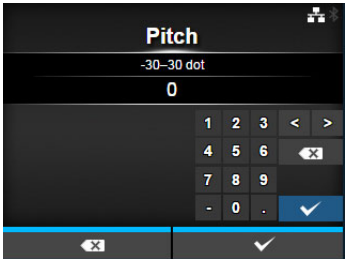

Darkness Adjust

Printing > Advanced > Adjustments > Darkness Adjust

Fine tune the print darkness.
The setting range is from 0 to 99.
0 is the lightest and 99 is the darkest.

Refer to **Darkness** in *Printing*.

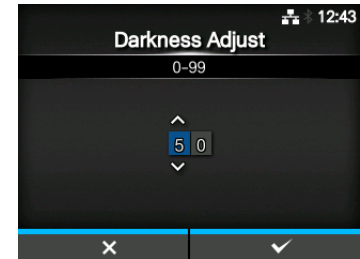

Start Online

Printing > Advanced > Start Online

Select default mode at power on.
The options are as follows:

- **Enabled:** The printer powers on in online mode.
- **Disabled:** The printer powers on in offline mode.

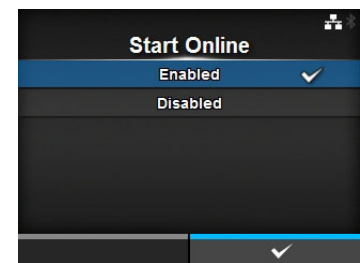

Feed After Error

Printing > Advanced > Feed After Error

Set whether to automatically feed the media when recovering from an error and changing to online mode.

The options are as follows:

- **Enabled:** Feed the media when changing to online mode after recovering from an error.
- **Disabled:** Do not feed the media when changing to online mode after recovering from an error.
However, if **Feed At Power On** is set to **Enabled**, the printer feeds the media when it is powered on and changes to online mode.

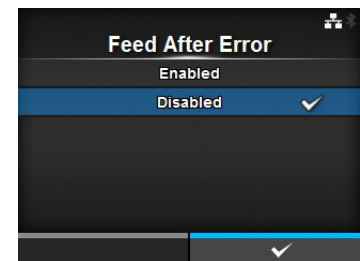

Feed At Power On

Printing > Advanced > Feed At Power On

Set whether to automatically feed the media at power on.

The options are as follows:

- **Enabled:** Feed the media when the printer is powered on.
- **Disabled:** Do not feed the media when the printer is powered on.
However, if **Feed After Error** is set to **Enabled**, the printer feeds the media when it is powered on and changes to online mode.

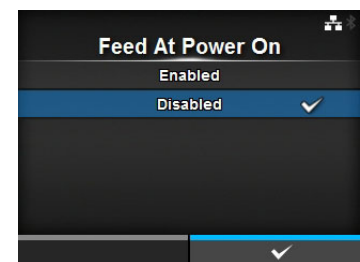

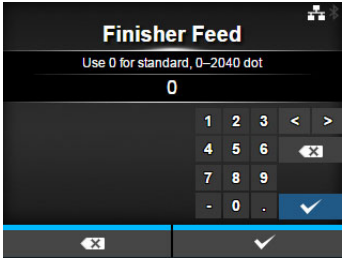
Finisher Feed	
<p><i>Printing > Advanced > Finisher Feed</i></p> <p>Set the media feed amount for Tear-off, cut and dispense stop. Set the media feed amount based on the print head position of 0. The actual media feed amount is the value of Offset + Finisher Feed. The setting range varies depending on the print resolution of the printer. The setting range is as follows:</p> <p><CL4NX></p> <ul style="list-style-type: none"> • 203 dpi: 0 to 2040 dots • 305 dpi: 0 to 3060 dots • 609 dpi: 0 to 6120 dots <p><CL6NX></p> <ul style="list-style-type: none"> • 203 dpi: 0 to 2040 dots • 305 dpi: 0 to 3060 dots 	 <p>The screenshot shows the 'Finisher Feed' menu with the current value set to 0. Below the value is a numeric keypad with digits 1-9, 0, and a decimal point. There are also navigation arrows and a checkmark button.</p>

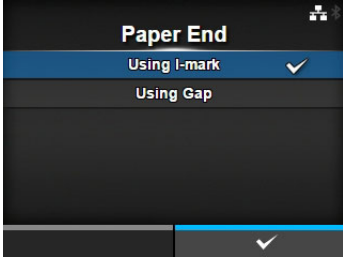
Paper End	
<p><i>Printing > Advanced > Paper End</i></p> <p>Select the sensor for sensing the paper end. The options are as follows:</p> <ul style="list-style-type: none"> • Using I-mark: Use the I-mark sensor (reflective type) to sense the paper end. • Using Gap: Use the Gap sensor (transmissive type) to sense the paper end. 	 <p>The screenshot shows the 'Paper End' menu with 'Using I-mark' selected and a checkmark next to it. 'Using Gap' is also visible as an option below.</p>

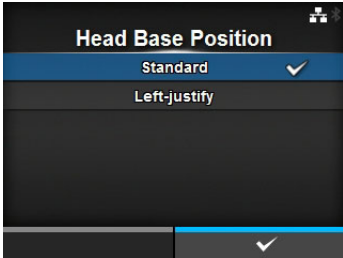
Head Base Position	
<p><i>Printing > Advanced > Head Base Position</i></p> <p>Set the position used for the base reference point for printing. The options are as follows:</p> <p><CL4NX></p> <ul style="list-style-type: none"> • Standard: Print with a standard base reference point. • Left-justify: Move the base reference point 2 mm (0.08”) to the left (when you face the printer). <p><CL6NX></p> <ul style="list-style-type: none"> • Standard: Print with a standard base reference point. • Left-justify: Move the base reference point 2 mm (0.08”) to the left (when you face the printer). Expand the width of the printable area. Refer to Printable Area in Section 7.7.1 Hardware for details. <hr/> <p>Note The message prompting to restart the printer will appear on the online/offline screen if you have made any changes. In such a case, reboot the printer to make the setting effective.</p>	 <p>The screenshot shows the 'Head Base Position' menu with 'Standard' selected and a checkmark next to it. 'Left-justify' is also visible as an option below.</p>

Prioritize

Printing > Advanced > Prioritize

For printer configuration, set whether to prioritize the settings through the printer or through commands.

The options are as follows:

- **Commands:** Prioritize the settings through commands.
- **Settings:** Prioritize the settings through the printer.

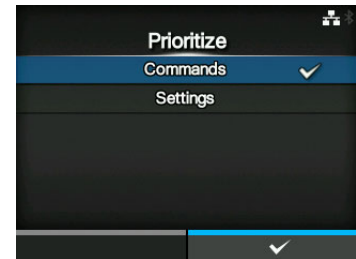

Reprint

Printing > Advanced > Reprint

Enable or disable the reprint function.

The options are as follows:

- **Enabled:** Enable the reprint function.
- **Disabled:** Disable the reprint function.

If you have selected **Enabled** in **Reprint**, you can press the right soft button (**REPRINT**) on the online screen to print the previous data again.

Note

The previous data will be lost if you power off the printer.

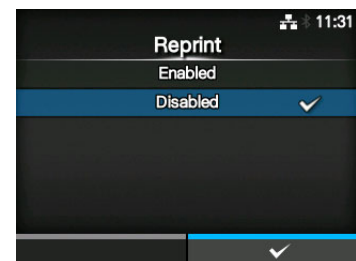

Print End Position

Printing > Advanced > Print End Position

Adjust the media stop position or cut position when **Sensor Type** is set to **None**. This adjustment also sets the blank amount from the media stop position.

The setting range varies depending on the print resolution of the printer.

The setting range is as follows:

<CL4NX>

- 203 dpi: 0 to 20000 dots
- 305 dpi: 0 to 18000 dots
- 609 dpi: 0 to 9600 dots

<CL6NX>

- 203 dpi: 0 to 20000 dots
- 305 dpi: 0 to 18000 dots

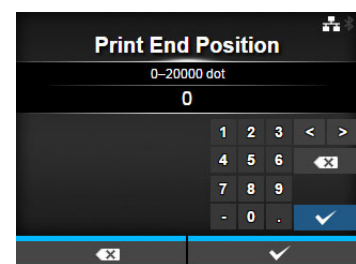

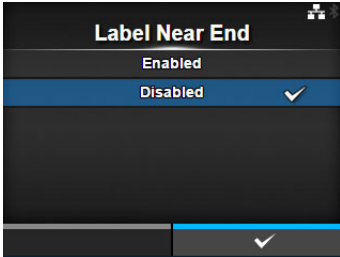
Label Near End	
<p><i>Printing > Advanced > Label Near End</i></p> <p>Show or do not show the warning icon when the media is about to run out. The options are as follows:</p> <ul style="list-style-type: none">• Enabled: Show the warning icon.• Disabled: Do not show the warning icon. <p>Label near end is detected by the label near end sensor. Label near end occurs when the amount of label remaining is less than approximately 12 meters (39.4 feet) (media thickness: 160 μm (0.0063"), label diameter: approximately $\phi 96$ mm (3" core)).</p> <hr/> <p>Note</p> <ul style="list-style-type: none">• This feature is supported on printers from serial number 6B~ and above. Although this setting shows on printers with serial number 6A~ or below, it is not supported.• Detection of the label near end is only for reference. The timing of label near end and paper end may overlap, or the paper end may occur before the label near end occurs depending on the label thickness and the top and bottom fluttering of the paper core.• The warning icon shows in the status bar on the upper part of the screen.	

4.4.3 Interface Menu

In the **Interface** menu, the setting items are as follows:

Interface		
1	Network	Set the LAN connection and wireless LAN connection.
2	IEEE1284	Set the IEEE1284 connection. *Shows only if the combo interface board is installed.
3	RS-232C	Set the RS-232C connection. *Shows only if the combo interface board is installed.
4	USB	Set the USB connection.
5	Bluetooth	Set the Bluetooth connection.
6	NFC	Set the NFC connection. *This feature is supported on printers from serial number 6B~ and above.
7	Ignore CR/LF	Set to ignore CR/LF codes.
8	Ignore CAN/DLE	Set to ignore CAN/DLE codes.
9	External I/O	Set the external signal (EXT). *Shows only if the combo interface board is installed.
10	RFID (CL4NX only)	Set the RFID. *Shows only for RFID models.

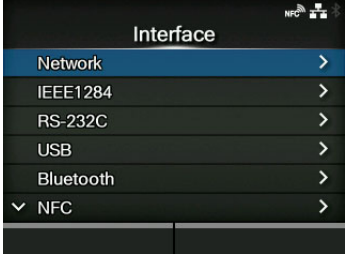

Network		
<p><i>Interface > Network</i></p> <p>To use LAN and wireless LAN for the interface between the host and the printer. The setting items are as follows:</p>		
1	Settings	Set the LAN, wireless LAN or select the interface.
2	Services	Set the TCP/IP port number, NTP, LPD, FTP or SNMP.
3	Advanced	Set the advanced function for the interface.

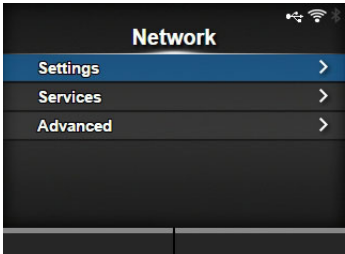

Settings		
<p><i>Interface > Network > Settings</i></p> <p>Set the LAN, wireless LAN or select the interface. The setting items are as follows:</p>		
1	LAN	Set the LAN.
2	Wi-Fi	Set the wireless LAN. *Shows only if you have installed the optional wireless LAN.
3	Interface	Select the network interface. *This item is to select the network interface from LAN or wireless LAN when you have installed the optional wireless LAN.
<p>CAUTION You cannot use LAN and wireless LAN at the same time. The wireless LAN function is available only if you have installed the wireless LAN.</p>		

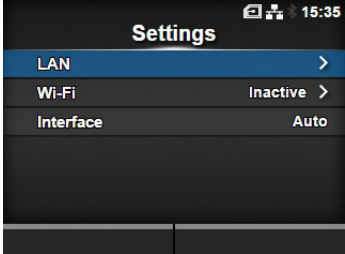

LAN		
<p><i>Interface > Network > Settings > LAN</i></p> <p>Set the IPv4, IPv6 or proxy for the LAN. The setting items are as follows:</p>		
1	IPv4	Set the IPv4 for the LAN.
2	IPv6	Set the IPv6 for the LAN.
3	Proxy	Set the proxy for the LAN.

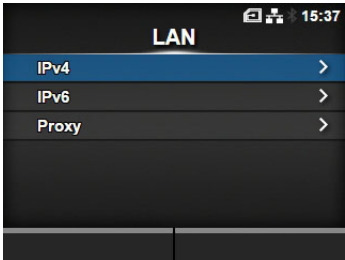

IPv4		
<p><i>Interface > Network > Settings > LAN > IPv4</i></p> <p>Set IPv4 for the LAN. The setting items are as follows:</p>		
1	Mode	Select the IP address assignment method.
2	DHCP / Renew Lease	Update the lease time and get the IP address from the DHCP server again. *Shows only if you have selected DHCP in the Mode menu and LAN is the active interface. *Does not show if WLAN is the active interface.
3	IP Address	Set and check the IP address. If you have selected DHCP in the Mode menu, the screen shows the IP address you received from the DHCP server. If you have selected Static in the Mode menu, select to set the IP address.
4	Netmask	Set and check the subnet mask address. If you have selected DHCP in the Mode menu, the screen shows the subnet mask address you received from the DHCP server. If you have selected Static in the Mode menu, select to set the subnet mask address.
5	Gateway	Set and check the default gateway address. If you have selected DHCP in the Mode menu, the screen shows the gateway address you received from the DHCP server. If you have selected Static in the Mode menu, select to set the default gateway address.
6	DNS	Set and check DNS server addresses. If you have selected Static in the Mode menu, select to set and check DNS server addresses.
<p>CAUTION After doing the settings, press the right soft button to enable the new settings. Press the left soft button to cancel the new settings and return to the previous settings.</p> <hr/> <p>Note You cannot change IP Address, Netmask, Gateway or DNS if Mode is DHCP.</p>		

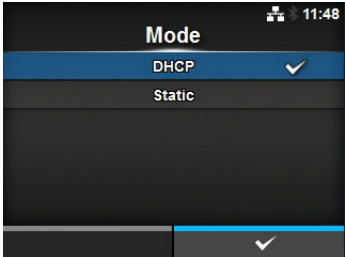
Mode	
<p><i>Interface > Network > Settings > LAN > IPv4 > Mode</i></p> <p>Select the IP address assignment method. The options are as follows:</p> <ul style="list-style-type: none"> • DHCP: Automatically retrieve the IP address, gateway and subnet mask from the DHCP server. • Static: Manually set the IP address, gateway and subnet mask. 	

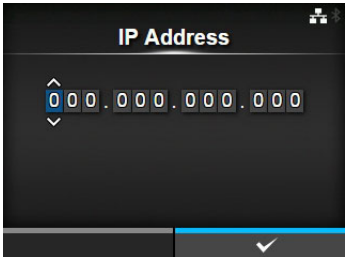
IP Address	
<p><i>Interface > Network > Settings > LAN > IPv4 > IP Address</i></p> <p>If you have selected Static in the Mode menu, set the IP address. The setting range is as follows: 000.000.000.000 to 255.255.255.255</p>	

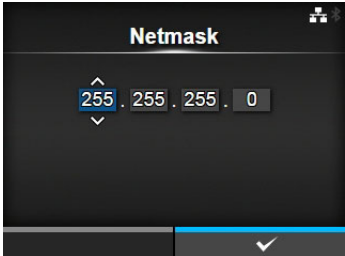
Netmask	
<p><i>Interface > Network > Settings > LAN > IPv4 > Netmask</i></p> <p>If you have selected Static in the Mode menu, set the subnet mask address. Each group of the address can be set cyclically among 0, 128, 192, 224, 240, 248, 252, 254 and 255. The setting range is as follows: 128.000.000.000 to 255.255.255.254</p>	

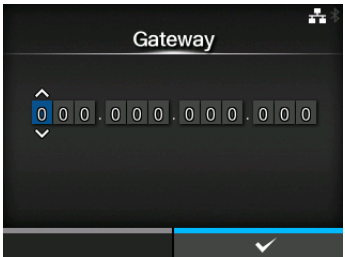
Gateway	
<p><i>Interface > Network > Settings > LAN > IPv4 > Gateway</i></p> <p>If you have selected Static in the Mode menu, set the default gateway address. The setting range is as follows: 000.000.000.000 to 255.255.255.255</p>	

DNS

Interface > Network > Settings > LAN > IPv4 > DNS

If you have selected **Static** in the **Mode** menu, set and check DNS server addresses.

The setting range is as follows:

000.000.000.000 to 255.255.255.255

Note

You can register up to three IP addresses for the DNS server. Use a comma to delimit different IP addresses.

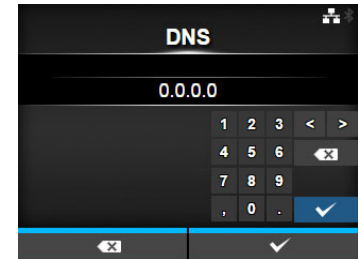

IPv6		
<p><i>Interface > Network > Settings > LAN > IPv6</i></p> <p>Set IPv6 for the LAN. The setting items are as follows:</p>		
1	Mode	Select the IP address assignment method or disable IPv6.
2	DHCP / Renew Lease	Update the lease time and get the IP address from the DHCP server again. *Shows only if you have selected DHCP in the Mode menu. *Does not show if WLAN is the active interface.
3	IP Address	Set and check the IP address. If you have selected DHCP in the Mode menu, the screen shows the IP address you received from the DHCP server. If you have selected Static in the Mode menu, select to set the IP address.
4	Prefix Length	Set and check the prefix.
5	Gateway	Set and check the default gateway address. If you have selected DHCP in the Mode menu, the screen shows the gateway address you received from the DHCP server. If you have selected Static in the Mode menu, select to set the default gateway address.
6	DNS	Set and check the address of the primary DNS server. If you have selected Static in the Mode menu, select to set the primary address of the DNS server.
<p>CAUTION After doing the settings, press the right soft button to enable the new settings. Press the left soft button to cancel the new settings and return to the previous settings.</p> <p>Note You cannot change IP Address, Prefix Length, Gateway or DNS if Mode is anything other than Static.</p>		

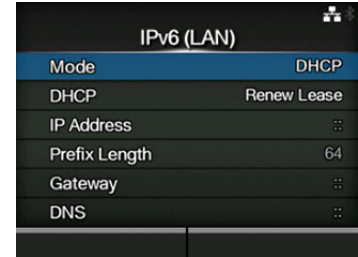

Mode

Interface > Network > Settings > LAN > IPv6 > Mode

Select the IP address assignment method or disable IPv6.

The options are as follows:

- **Disable:** Disable IPv6.
- **Auto:** Automatically generate the IP address and gateway (stateless mode).
- **DHCP:** Automatically retrieve the IP address and gateway from the DHCP server automatically (stateful mode).
- **Static:** Manually set the IP address, gateway and prefix length.

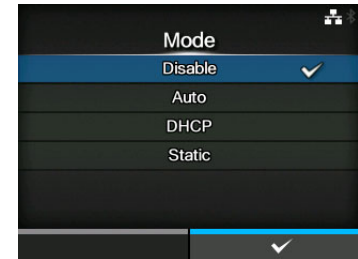

IP Address

Interface > Network > Settings > LAN > IPv6 > IP Address

If you have selected **Static** in the **Mode** menu, set the IP address.

The setting range is as follows:

0:0:0:0:0:0:1 to ffff:ffff:ffff:ffff:ffff:ffff:ffff



Prefix Length

Interface > Network > Settings > LAN > IPv6 > Prefix Length

If you have selected **Static** in the **Mode** menu, set the prefix.

The setting range is from 1 to 128.

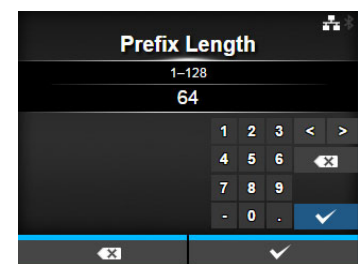

Gateway

Interface > Network > Settings > LAN > IPv6 > Gateway

If you have selected **Static** in the **Mode** menu, set the default gateway address.

The setting range is as follows:

0:0:0:0:0:0:0:0 to ffff:ffff:ffff:ffff:ffff:ffff:ffff:ffff

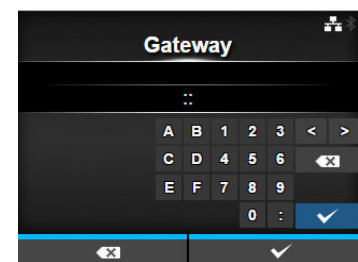

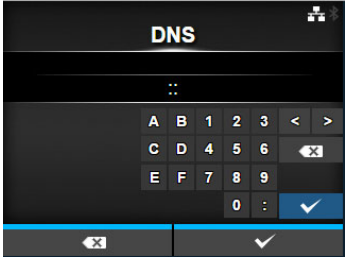
DNS		
<p><i>Interface > Network > Settings > LAN > IPv6 > DNS</i></p> <p>If you have selected Static in the Mode menu, set the primary address of the DNS server. The setting range is as follows: 0:0:0:0:0:0:0:0 to ffff:ffff:ffff:ffff:ffff:ffff:ffff:ffff</p> <hr/> <p>Note You can register only one IP address for the DNS server for IPv6.</p>		

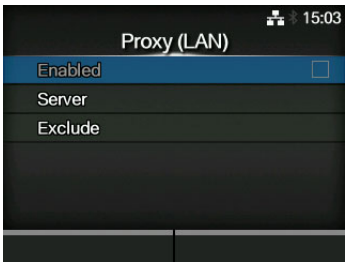
Proxy										
<p><i>Interface > Network > Settings > LAN > Proxy</i></p> <p>Set the proxy for the LAN. The setting items are as follows:</p>										
1	<table border="1"> <tr> <td>Enabled</td> <td>Enable or disable use of proxy.</td> </tr> <tr> <td>2</td> <td>Server</td> <td>Set the proxy server address.</td> </tr> <tr> <td>3</td> <td>Exclude</td> <td>Exclude the proxy server usage.</td> </tr> </table>		Enabled	Enable or disable use of proxy.	2	Server	Set the proxy server address.	3	Exclude	Exclude the proxy server usage.
Enabled	Enable or disable use of proxy.									
2	Server	Set the proxy server address.								
3	Exclude	Exclude the proxy server usage.								

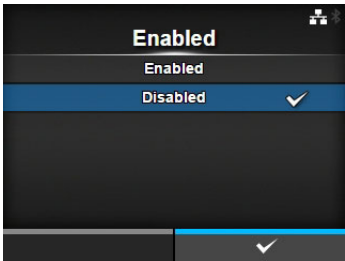
Enabled		
<p><i>Interface > Network > Settings > LAN > Proxy > Enabled</i></p> <p>Enable or disable use of proxy. The options are as follows:</p> <ul style="list-style-type: none"> • Enabled: Enable proxy server usage. • Disabled: Disable proxy server usage. <hr/> <p>Note To enable the proxy, Server should be set and Exclude must contain at least 127.0.0.1 and localhost.</p>		

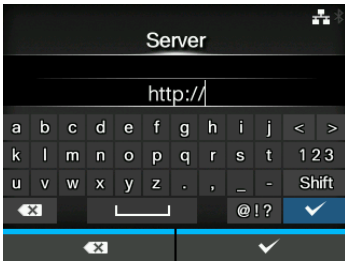
Server		
<p><i>Interface > Network > Settings > LAN > Proxy > Server</i></p> <p>Set the name or IP address of the proxy server.</p> <hr/> <p>Note Server should be set with a valid name or IP address and port number.</p>		

Exclude

Interface > Network > Settings > LAN > Proxy > Exclude

Set names, IP addresses or domains for the proxy to exclude.

Note

Exclude must contain at least 127.0.0.1 and localhost.

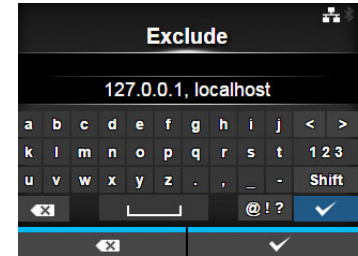

Wi-Fi		
<p><i>Interface > Network > Settings > Wi-Fi</i></p> <p>Set the wireless LAN. Shows only if you have installed the optional wireless LAN. The setting items are as follows:</p>		
1	IPv4	Configure IPv4 for Wi-Fi.
2	IPv6	Configure IPv6 for Wi-Fi.
3	Proxy	Configure the proxy for Wi-Fi.
4	Wi-Fi Protected Setup	Set the wireless LAN connection with the Wi-Fi Protected Setup (WPS) function.
5	Wi-Fi Direct	Set the Wi-Fi Direct function. *Enabled only if you have selected Infrastructure in the Mode menu.
6	SSID	Set the SSID.
7	Hidden SSID	Set the Hidden SSID. *Shows only if you have selected Infrastructure in the Mode menu.
8	Mode	Set the communication mode.
9	Channel	Set the communication channel.
10	Security	Set the security (encryption method).
11	WEP Conf.	Set the WEP key. *Shows only if you have selected WEP in the Security menu.
12	WPA Conf.	Set the WPA authentication. *Shows only if you have selected WPA+WPA2 or WPA2 in the Security menu.
13	EAP Conf.	Set the EAP authentication. *Shows only if you have selected Dynamic WEP in the Security menu.
<p>CAUTION After doing the settings, press the right soft button to enable the new settings. Press the left soft button to cancel the new settings and return to the previous settings.</p>		
<p>Note When Wi-Fi Direct is active, IPv6 and Wi-Fi Protected Setup are not shown on the screen.</p>		



The screenshot shows the 'Wi-Fi' settings screen. At the top, it says 'Wi-Fi' with signal strength and time (09:20) indicators. Below are several menu items with right-pointing chevrons: IPv4, IPv6, Proxy, Wi-Fi Protected Setup, and Wi-Fi Direct. At the bottom, there is a 'SSID' section with a dropdown arrow and the text 'sato_guest'.

IPv4		
<p><i>Interface > Network > Settings > Wi-Fi > IPv4</i></p> <p>Configure IPv4 for Wi-Fi. The setting items are as follows:</p>		
1	Mode	Select the IP address assignment method.
2	DHCP / Renew Lease	Update the lease time and get the IP address from the DHCP server again. *Shows only if you have selected DHCP in the Mode menu. *Does not show if LAN is the active interface.
3	IP Address	Set and check the IP address. If you have selected DHCP in the Mode menu, the screen shows the IP address you received from the DHCP server. If you have selected Static in the Mode menu, select to set the IP address.
4	Netmask	Set and check the subnet mask address. If you have selected DHCP in the Mode menu, the screen shows the subnet mask address you received from the DHCP server. If you have selected Static in the Mode menu, select to set the subnet mask address.
5	Gateway	Set and check the default gateway address. If you have selected DHCP in the Mode menu, the screen shows the gateway address you received from the DHCP server. If you have selected Static in the Mode menu, select to set the default gateway address.
6	DNS	Set and check DNS server addresses. If you have selected Static in the Mode menu, select to set and check DNS server addresses.
<p>CAUTION</p> <p>After doing the settings, return to the Wi-Fi screen by pressing the  back button, and then press the right soft button to enable the new settings. Press the left soft button to cancel the new settings and return to the previous settings.</p> <hr/> <p>Note</p> <p>When Wi-Fi Direct is active, Mode, DHCP and DNS are not shown. In addition, you cannot change IP Address, Netmask or Gateway if Mode is DHCP or Wi-Fi Direct is active. DNS cannot be changed if Mode is DHCP.</p>		

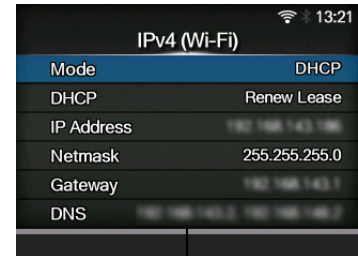

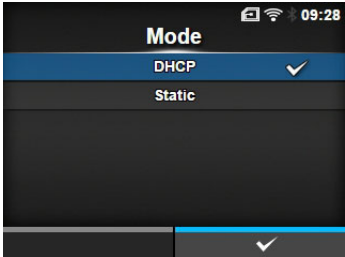
Mode	
<p><i>Interface > Network > Settings > Wi-Fi > IPv4 > Mode</i></p> <p>Select the IP address assignment method. The options are as follows:</p> <ul style="list-style-type: none"> • DHCP: Automatically retrieve the IP address, gateway and subnet mask from the DHCP server. • Static: Manually set the IP address, gateway and subnet mask. 	

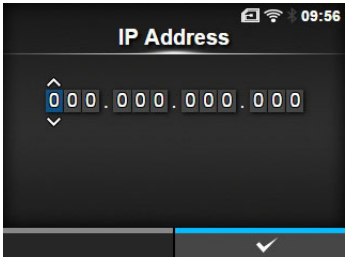
IP Address	
<p><i>Interface > Network > Settings > Wi-Fi > IPv4 > IP Address</i></p> <p>If you have selected Static in the Mode menu, set the IP address. The setting range is as follows: 000.000.000.000 to 255.255.255.255</p>	

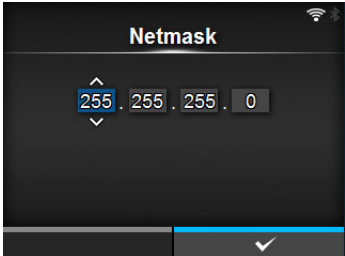
Netmask	
<p><i>Interface > Network > Settings > Wi-Fi > IPv4 > Netmask</i></p> <p>If you have selected Static in the Mode menu, set the subnet mask address. Each group of the address can be set cyclically among 0, 128, 192, 224, 240, 248, 252, 254 and 255. The setting range is as follows: 128.000.000.000 to 255.255.255.254</p>	

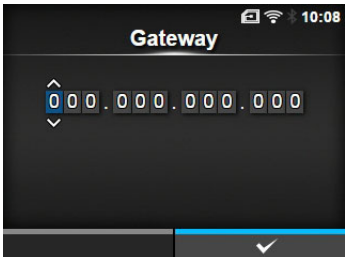
Gateway	
<p><i>Interface > Network > Settings > Wi-Fi > IPv4 > Gateway</i></p> <p>If you have selected Static in the Mode menu, set the default gateway address. The setting range is as follows: 000.000.000.000 to 255.255.255.255</p>	

DNS

Interface > Network > Settings > Wi-Fi > IPv4 > DNS

If you have selected **Static** in the **Mode** menu, set and check DNS server addresses.

The setting range is as follows:

000.000.000.000 to 255.255.255.255

Note

You can register up to three IP addresses for the DNS server. Use a comma to delimit different IP addresses.

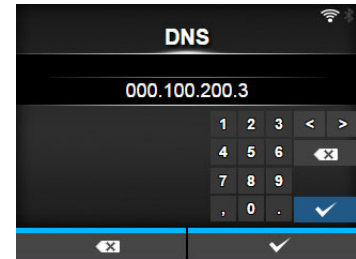

IPv6		
<p><i>Interface > Network > Settings > Wi-Fi > IPv6</i></p> <p>Configure IPv6 for Wi-Fi. The setting items are as follows:</p>		
1	Mode	Select the IP address assignment method or disable IPv6.
2	DHCP / Renew Lease	Update the lease time and get the IP address from the DHCP server again. *Shows only if you have selected DHCP in the Mode menu. *Does not show if LAN is the active interface.
3	IP Address	Set and check the IP address. If you have selected DHCP in the Mode menu, the screen shows the IP address you received from the DHCP server. If you have selected Static in the Mode menu, select to set the IP address.
4	Prefix Length	Set and check the prefix.
5	Gateway	Set and check the default gateway address. If you have selected DHCP in the Mode menu, the screen shows the gateway address you received from the DHCP server. If you have selected Static in the Mode menu, select to set the default gateway address.
6	DNS	Set and check the address of the primary DNS server. If you have selected Static in the Mode menu, select to set the primary address of the DNS server.
<p>CAUTION</p> <p>After doing the settings, return to the Wi-Fi screen by pressing the  back button, and then press the right soft button to enable the new settings. Press the left soft button to cancel the new settings and return to the previous settings.</p> <hr/> <p>Note</p> <p>When Wi-Fi Direct is active, this IPv6 screen is not shown. In addition, you cannot change IP Address, Prefix Length, Gateway or DNS if Mode is anything other than Static.</p>		

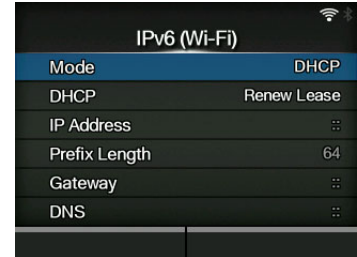

Mode

Interface > Network > Settings > Wi-Fi > IPv6 > Mode

Select the IP address assignment method or disable IPv6.

The options are as follows:

- **Disable:** Disable IPv6.
- **Auto:** Automatically generate the IP address and gateway (stateless mode).
- **DHCP:** Automatically retrieve the IP address and gateway from the DHCP server automatically (stateful mode).
- **Static:** Manually set the IP address, gateway and prefix length.

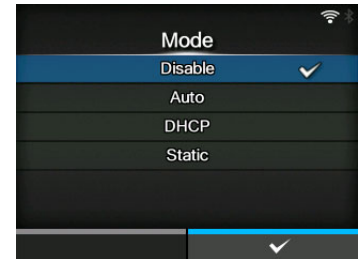

IP Address

Interface > Network > Settings > Wi-Fi > IPv6 > IP Address

If you have selected **Static** in the **Mode** menu, set the IP address.

The setting range is as follows:

0:0:0:0:0:0:1 to ffff:ffff:ffff:ffff:ffff:ffff:ffff

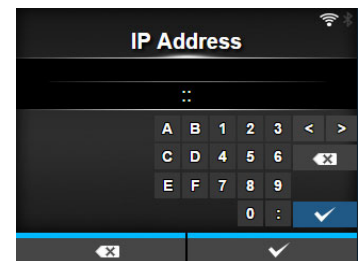

Prefix Length

Interface > Network > Settings > Wi-Fi > IPv6 > Prefix Length

If you have selected **Static** in the **Mode** menu, set the prefix.

The setting range is from 1 to 128.

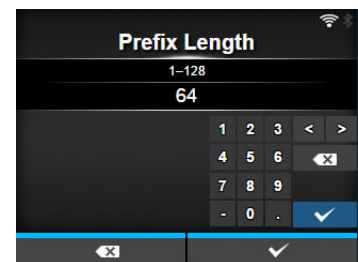

Gateway

Interface > Network > Settings > Wi-Fi > IPv6 > Gateway

If you have selected **Static** in the **Mode** menu, set the default gateway address.

The setting range is as follows:

0:0:0:0:0:0:0 to ffff:ffff:ffff:ffff:ffff:ffff:ffff

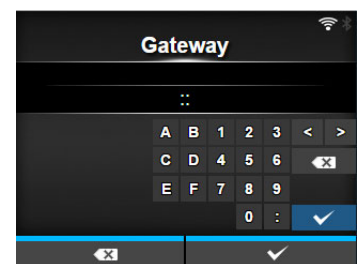

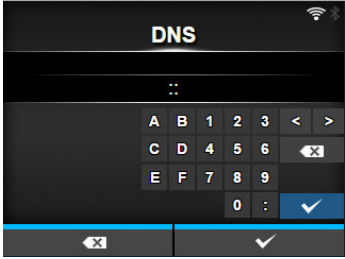
DNS	
<p><i>Interface > Network > Settings > Wi-Fi > IPv6 > DNS</i></p> <p>If you have selected Static in the Mode menu, set the primary address of the DNS server. The setting range is as follows: 0:0:0:0:0:0:0:0 to ffff:ffff:ffff:ffff:ffff:ffff:ffff:ffff</p> <hr/> <p>Note You can register only one IP address for the DNS server for IPv6.</p>	

Proxy		
<p><i>Interface > Network > Settings > Wi-Fi > Proxy</i></p> <p>Configure the proxy for Wi-Fi. The setting items are as follows:</p>		
1	Enabled	Enable or disable use of proxy.
2	Server	Set the proxy server address.
3	Exclude	Exclude the proxy server usage.

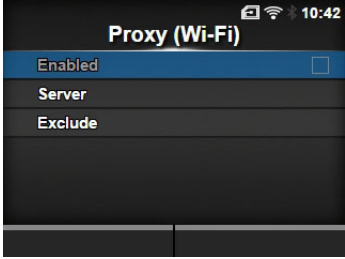

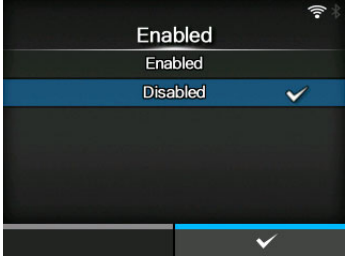
Enabled	
<p><i>Interface > Network > Settings > Wi-Fi > Proxy > Enabled</i></p> <p>Enable or disable use of proxy. The options are as follows:</p> <ul style="list-style-type: none"> • Enabled: Enable proxy server usage. • Disabled: Disable proxy server usage. <hr/> <p>Note To enable the proxy, Server should be set and Exclude must contain at least 127.0.0.1 and localhost.</p>	

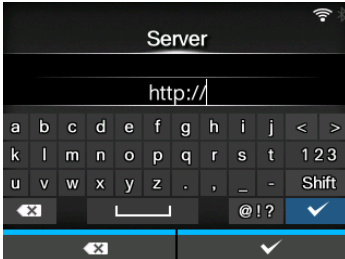
Server	
<p><i>Interface > Network > Settings > Wi-Fi > Proxy > Server</i></p> <p>Set the name or IP address of the proxy server.</p> <hr/> <p>Note Server should be set with a valid name or IP address and port number.</p>	

Exclude

Interface > Network > Settings > Wi-Fi > Proxy > Exclude

Set names, IP addresses or domains for the proxy to exclude.

Note

Exclude must contain at least 127.0.0.1 and localhost.

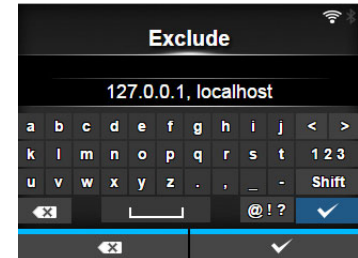

Wi-Fi Protected Setup

Interface > Network > Settings > Wi-Fi > Wi-Fi Protected Setup

Set the wireless LAN connection using the push button or PIN code method.

The setting items are as follows:

1	Button (PBC)	Set the wireless LAN connection using the push button method.
2	PIN	Set the wireless LAN connection using the PIN code method.

Note

- Refer to the manual of the access point device for its operation.
- This screen does not show if LAN or Wi-Fi Direct is active.



Button (PBC)

Interface > Network > Settings > Wi-Fi > Wi-Fi Protected Setup > Button (PBC)

Set the wireless LAN connection using the push button method.

1. Select **Button (PBC)** in the **Wi-Fi Protected Setup** menu and press the **←** button.
2. When **Scanning...** shows on the screen, press the WPS button on the access point of the wireless LAN device.
3. When the connection to the access point is established, **Successfully configured.** shows on the screen.

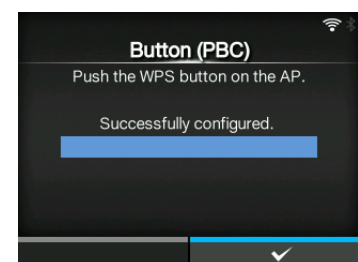
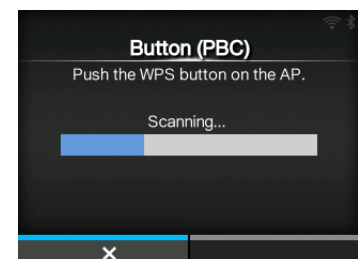

PIN

Interface > Network > Settings > Wi-Fi > Wi-Fi Protected Setup > PIN

Set the wireless LAN connection using the PIN code method.

1. Select **PIN** in the **Wi-Fi Protected Setup** menu and press the  button.
2. When **Scanning...** shows on the screen, set the PIN code shown on the screen to the access point of the wireless LAN or computer.
3. When the connection to the access point is established, **Successfully configured.** shows on the screen.

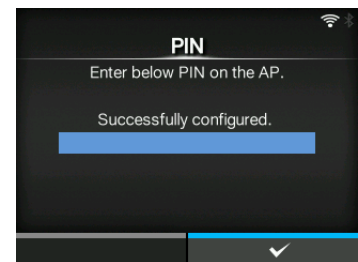
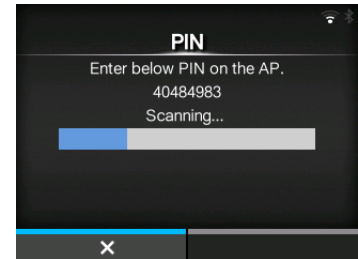



Wi-Fi Direct

Interface > Network > Settings > Wi-Fi > Wi-Fi Direct

Set the Wi-Fi Direct function.

*The Wi-Fi Direct function is enabled only if you have selected **Infrastructure** in the **Mode** menu. If you have changed the setting from **Ad-hoc** to **Infrastructure** in the **Mode** menu, reboot the printer before setting the Wi-Fi Direct function.

The setting procedure is as follows:

1. Set the device name for the printer using **Device Name**. You can enter 1 to 32 characters including alphabets (capital and small letters), numbers and symbols. Press the  button to return to **Wi-Fi** menu and press the right soft button to enable changes.
2. Select **Connect** to search and show the connectable device names or to accept connection requests when printer is GO (Group Owner).
Select the device name you want to connect using the  /  buttons, then press the right soft button.
3. Select **Start Group** if you want to start a new persistent group or select a group from the list.
4. Select **Remove Group** to remove the persistent group in step 3.
5. Complete the connection according to the display on the printer or device you want to connect.
6. Select **Disconnect** if you want to stop the connection.

Note

You can connect a maximum of ten devices.

When Wi-Fi Direct is active, **Device Name** cannot be changed.

Start Group and **Remove Group** show only if Wi-Fi is active and the printer is not connected to a Wi-Fi Direct network.

Disconnect shows if Wi-Fi is active and the printer is connected.

After setting up a start group, the printer will be set to GO (Group Owner) and will wait for a connection request from another device.

If the printer is powered off during a persistent group connection, the group will be started automatically after the printer is powered on.

Connect without group



Connect with group

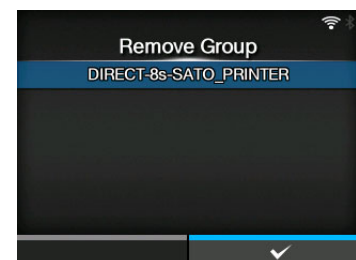
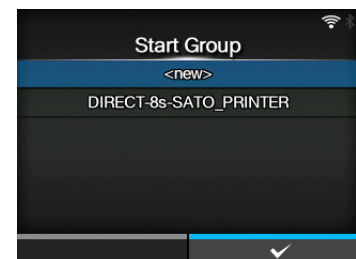

SSID	
<p><i>Interface > Network > Settings > Wi-Fi > SSID</i></p> <p>Set the SSID. The screen shows the Wi-Fi network detected by the printer. Select the name of the Wi-Fi network you want to connect using the ▲ / ▼ buttons and press the right soft button to confirm. To register a Wi-Fi network manually, press the left soft button and enter the name of the network. You can enter a maximum of thirty-two characters including alphabet (upper case and lower case), numbers and symbols.</p>	

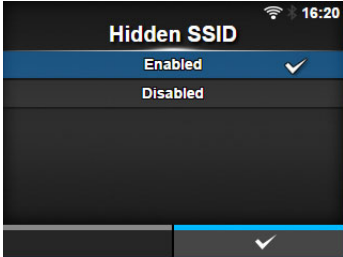
Hidden SSID	
<p><i>Interface > Network > Settings > Wi-Fi > Hidden SSID</i></p> <p>Set the Hidden SSID (stealth function). Shows if you have selected Infrastructure in the Mode menu. The options are as follows:</p> <ul style="list-style-type: none"> • Enabled • Disabled 	

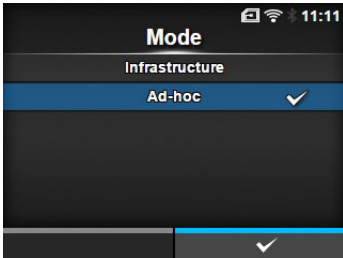
Mode	
<p><i>Interface > Network > Settings > Wi-Fi > Mode</i></p> <p>Set the communication method of the wireless LAN. The options are as follows:</p> <ul style="list-style-type: none"> • Infrastructure • Ad-hoc 	

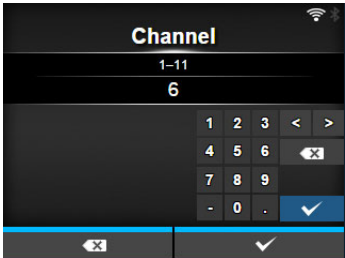
Channel	
<p><i>Interface > Network > Settings > Wi-Fi > Channel</i></p> <p>Set the communication channel. Channel can be set only if you have selected Ad-hoc in the Mode menu. The number of channels you can set varies depending on the region of the printer.</p>	

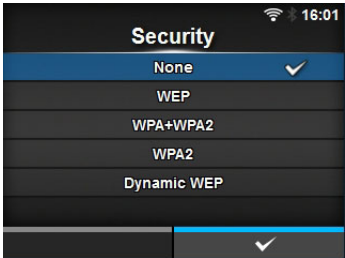
Security	
<p><i>Interface > Network > Settings > Wi-Fi > Security</i></p> <p>Set the security method of the network. Set the security methods so that the printer, host and network devices match. The options are as follows:</p> <ul style="list-style-type: none"> • None • WEP • WPA+WPA2 • WPA2 • Dynamic WEP <p>If you have selected Ad-hoc in the Mode menu, only None and WEP will be available in the Security menu.</p>	

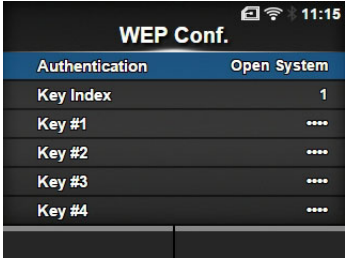
WEP Conf.										
<p><i>Interface > Network > Settings > Wi-Fi > WEP Conf.</i></p> <p>Set the WEP key. Shows only if you have selected WEP in the Security menu. The setting items are as follows:</p> <table border="1" style="width: 100%; border-collapse: collapse;"> <tr> <td style="width: 5%; text-align: center;">1</td> <td style="width: 20%;">Authentication</td> <td>Set the WEP authentication method.</td> </tr> <tr> <td style="text-align: center;">2</td> <td>Key Index</td> <td>Set the key index.</td> </tr> <tr> <td style="text-align: center;">3</td> <td>Key #1 - Key #4</td> <td>Set the WEP key1 - key4.</td> </tr> </table>	1	Authentication	Set the WEP authentication method.	2	Key Index	Set the key index.	3	Key #1 - Key #4	Set the WEP key1 - key4.	
1	Authentication	Set the WEP authentication method.								
2	Key Index	Set the key index.								
3	Key #1 - Key #4	Set the WEP key1 - key4.								

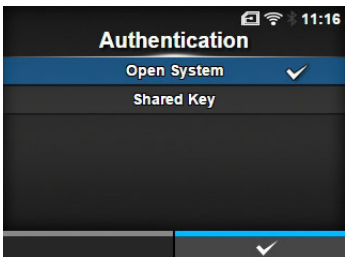
Authentication	
<p><i>Interface > Network > Settings > Wi-Fi > WEP Conf. > Authentication</i></p> <p>Set the WEP authentication method. The options are as follows:</p> <ul style="list-style-type: none"> • Open System • Shared Key 	

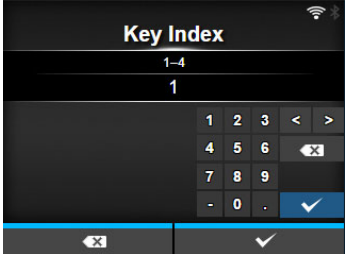
Key Index	
<p><i>Interface > Network > Settings > Wi-Fi > WEP Conf. > Key Index</i></p> <p>Set the key index. Set the key index (WEP key) according to the access point of the wireless LAN you connect. The setting range is from 1 to 4.</p> <hr/> <p>CAUTION Depending on the product, the range of the key index may be 0 to 3. In such a case, if you have set the printer to 1, then set the product to 0.</p>	

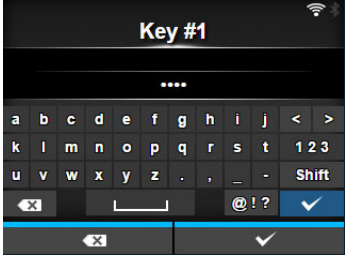
Key #1 - Key #4	
<p><i>Interface > Network > Settings > Wi-Fi > WEP Conf. > Key #1 - Key #4</i></p> <p>Set the WEP key #1 - key #4. You can enter alphabet (upper case and lower case) and numbers. Depending on the length of the WEP key, the number of characters you can set is as follows:</p> <ul style="list-style-type: none"> • When the key length is 64 bit ASCII: Five characters Hexadecimal: Ten characters • When the key length is 128 bit ASCII: Thirteen characters Hexadecimal: Twenty-six characters 	

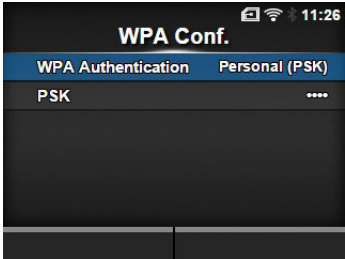
WPA Conf.			
<p><i>Interface > Network > Settings > Wi-Fi > WPA Conf.</i></p> <p>Set the WPA authentication. Shows only if you have selected WPA+WPA2 or WPA2 in the Security menu. The setting items are as follows:</p>			
1	WPA Authentication	Set the WPA authentication method.	
2	PSK	Set the PSK shared key. *Shows only if you have selected Personal (PSK) in the WPA Authentication menu.	
3	EAP Conf.	Set the functions for EAP. *Shows only if you have selected items other than Personal (PSK) in the WPA Authentication menu.	

WPA Authentication

Interface > Network > Settings > Wi-Fi > WPA Conf. > WPA Authentication

Set the WPA authentication method.

The options are as follows:

- **Personal (PSK)**
- **Enterprise (802.1x)**
- **CCKM**

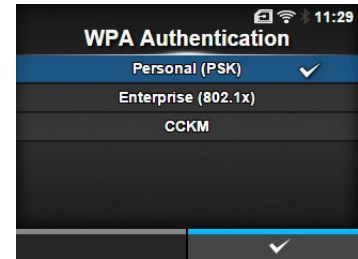

PSK

Interface > Network > Settings > Wi-Fi > WPA Conf. > PSK

Set the PSK shared key.

Shows only if you have selected **Personal (PSK)** in the **WPA Authentication** menu.

You can enter alphabetic, numeric and symbolic characters in the range of 8-63 ASCII or 64 hexadecimal digits.

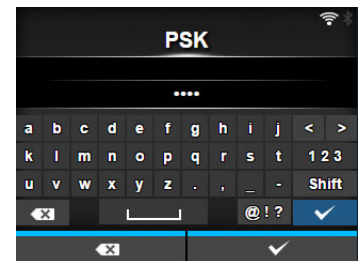

EAP Conf.		
<p><i>Interface > Network > Settings > Wi-Fi > EAP Conf.</i></p> <p><i>Interface > Network > Settings > Wi-Fi > WPA Conf. > EAP Conf.</i></p> <p>Set the functions for EAP. Shows only if you have selected an item other than Personal (PSK) in the WPA Authentication menu or if you have selected Dynamic WEP in the Security menu. The setting items are as follows:</p>		
1	EAP Mode	Set the EAP Mode (authentication mode).
2	Inner Method	Set the inner method. *Shows only if you have selected FAST , PEAP or TTLS in the EAP Mode menu.
3	Username	Set the user name.
4	Password	Set the password.
5	Anon. Outer ID	Set the external ID. *Shows only if you have selected FAST , PEAP or TTLS in the EAP Mode menu.
6	Verify Server Cert.	Enable or disable server authentication. *Shows only if you have selected anything other than LEAP in the EAP Mode menu.
7	Private Key P/W	Set the Private Key password. *Shows only if you have selected TLS in either the EAP Mode menu or Inner Method menu.
8	PAC Auto Provisioning	Enable or disable PAC Auto Provisioning. *Shows only if you have selected FAST in the EAP Mode menu.
9	PAC P/W	Set the PAC password. *Shows only if you have selected FAST in the EAP Mode menu and if you have selected Disabled in PAC Auto Provisioning .

EAP Mode	
<p><i>Interface > Network > Settings > Wi-Fi > EAP Conf. > EAP Mode</i></p> <p><i>Interface > Network > Settings > Wi-Fi > WPA Conf. > EAP Conf. > EAP Mode</i></p> <p>Set the EAP Mode (authentication mode). The options are as follows:</p> <ul style="list-style-type: none"> • FAST • LEAP • PEAP • TLS • TTLS 	

Inner Method

Interface > Network > Settings > Wi-Fi > EAP Conf. > Inner Method

Interface > Network > Settings > Wi-Fi > WPA Conf. > EAP Conf. > Inner Method

Set the inner method.

Shows only if you have selected **FAST**, **PEAP** or **TTLS** in the **EAP Mode** menu.

- If you have selected **FAST** in the **EAP Mode** menu, the options are **MSCHAPv2**, **GTC** and **TLS**.
- If you have selected **PEAP** in the **EAP Mode** menu, the options are **MSCHAPv2**, **GTC**, **MD5**, **OTP** and **TLS**.
- If you have selected **TTLS** in the **EAP Mode** menu, the options are **MSCHAPv2**, **MSCHAP**, **CHAP**, **PAP**, **EAP-GTC**, **EAP-MD5**, **EAP-MSCHAPV2**, **EAP-OTP** and **EAP-TLS**.

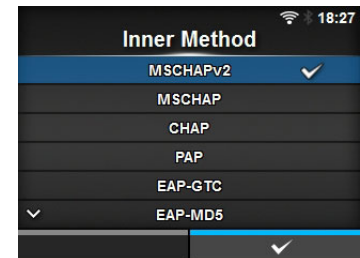

Username

Interface > Network > Settings > Wi-Fi > EAP Conf. > Username

Interface > Network > Settings > Wi-Fi > WPA Conf. > EAP Conf. > Username

Set the user name.

You can enter alphabetic, numeric and symbolic characters in the range of 0 to 63 characters.

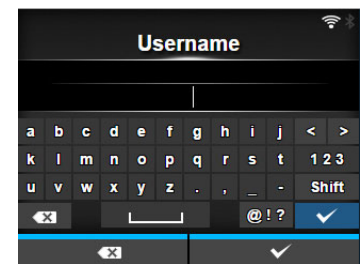

Password

Interface > Network > Settings > Wi-Fi > EAP Conf. > Password

Interface > Network > Settings > Wi-Fi > WPA Conf. > EAP Conf. > Password

Set the password.

You can enter alphabetic, numeric and symbolic characters in the range of 0 to 32 characters.

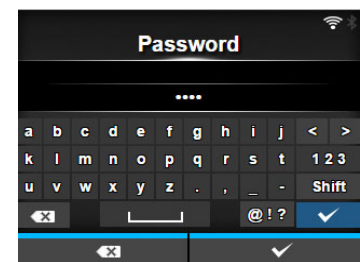

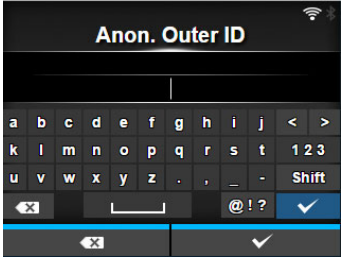
Anon. Outer ID	
<p><i>Interface > Network > Settings > Wi-Fi > EAP Conf. > Anon. Outer ID</i></p> <p><i>Interface > Network > Settings > Wi-Fi > WPA Conf. > EAP Conf. > Anon. Outer ID</i></p> <p>Set the external ID. Shows only if you have selected FAST, PEAP or TTLS in the EAP Mode menu. You can enter alphabetic, numeric and symbolic characters in the range of 0 to 63 characters.</p>	

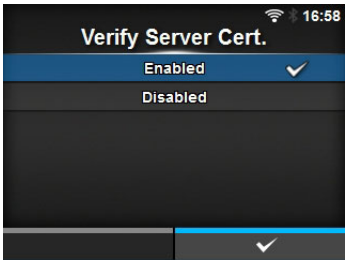
Verify Server Cert.	
<p><i>Interface > Network > Settings > Wi-Fi > EAP Conf. > Verify Server Cert.</i></p> <p><i>Interface > Network > Settings > Wi-Fi > WPA Conf. > EAP Conf. > Verify Server Cert.</i></p> <p>Enable or disable server certificate validation. Shows only if you have selected anything other than LEAP in the EAP Mode menu. The options are as follows:</p> <ul style="list-style-type: none"> • Enabled: Enable server certificate validation. • Disabled: Disable server certificate validation. 	

Private Key P/W	
<p><i>Interface > Network > Settings > Wi-Fi > EAP Conf. > Private Key P/W</i></p> <p><i>Interface > Network > Settings > Wi-Fi > WPA Conf. > EAP Conf. > Private Key P/W</i></p> <p>Set the Private Key password. Shows only if you have selected TLS in either the EAP Mode menu or Inner Method menu. You can enter alphabetic, numeric and symbolic characters in the range of 0 to 64 characters.</p>	

PAC Auto Provisioning

Interface > Network > Settings > Wi-Fi > EAP Conf. > PAC Auto Provisioning

Interface > Network > Settings > Wi-Fi > WPA Conf. > EAP Conf. > PAC Auto Provisioning

Enable or disable PAC Auto Provisioning.
Shows only if you have selected **FAST** in the **EAP Mode** menu.
The options are as follows:

- **Enabled:** Enable PAC Auto Provisioning.
- **Disabled:** Disable PAC Auto Provisioning.

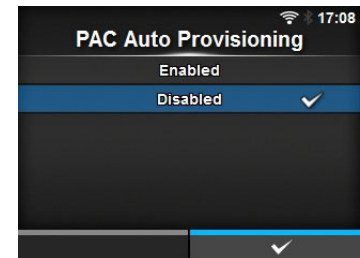

PAC P/W

Interface > Network > Settings > Wi-Fi > EAP Conf. > PAC P/W

Interface > Network > Settings > Wi-Fi > WPA Conf. > EAP Conf. > PAC P/W

Set the PAC password.
Shows only if you have selected **FAST** in the **EAP Mode** menu and if you have selected **Disabled** in the **PAC Auto Provisioning**.
You can enter alphabetic, numeric and symbolic characters in the range of 0 to 64 characters.

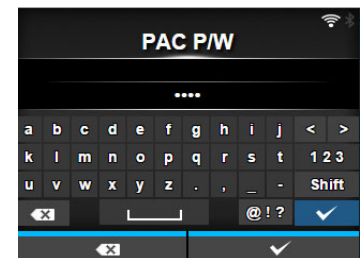

Interface

Interface > Network > Settings > Interface

Select the network interface.
This item is to select the network interface from LAN or wireless LAN when you have installed the optional wireless LAN.
The options are as follows:

- **Auto:** Automatically select between LAN and wireless LAN interface at printer startup. LAN is selected if LAN cable is connected to a link established hub (Link LED is flashing) at printer startup. Wireless LAN is selected if LAN is not detected at printer startup.
- **LAN:** Use LAN interface (or Force LAN interface).
- **Wi-Fi:** Use wireless LAN interface (or Force wireless LAN interface). Shows only if you have installed the optional wireless LAN.

Note

The message prompting to restart the printer will appear on the online/offline screen if you have made any changes. In such a case, reboot the printer to make the setting effective.

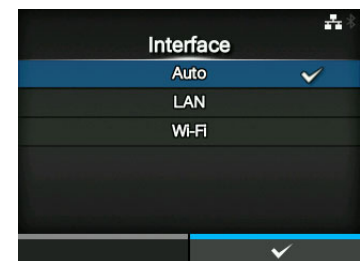

Services		
<p><i>Interface > Network > Services</i></p> <p>Set the TCP/IP port number, NTP, LPD, FTP or SNMP. The setting items are as follows:</p>		
1	Ports	Set the port number.
2	NTP	Set the functions for NTP.
3	LPD	Set the functions for LPD.
4	FTP	Set the functions for FTP.
5	SNMP	Set the functions for SNMP.
6	Online Services	This service is currently only available in Japan.

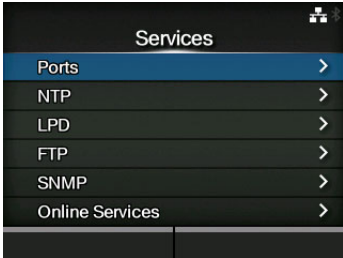

Ports		
<p><i>Interface > Network > Services > Ports</i></p> <p>The setting items are as follows:</p>		
1	Port1	Set the port number.
2	Port2	Set the port number.
3	Port3	Set the port number.
4	Flow Control	Set the communication protocol.
5	Multiple connections	Set whether to receive connection requests from multiple hosts or applications.
6	Legacy Status for Port 9100	Set whether to change the return status format of port3 to legacy status. *Does not show if you have selected None in the Flow Control menu.
7	BCC	Set the BCC check function. *Shows only if you have selected Status5 in the Flow Control menu.

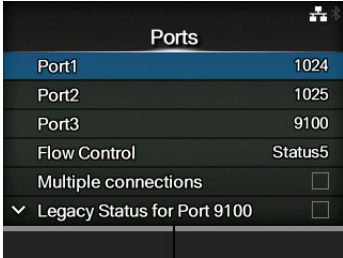

Port1	
<p><i>Interface > Network > Services > Ports > Port1</i></p> <p>Set the port number. The setting range is from 1 to 65535. Each port (1, 2 and 3) must be set to different values.</p>	

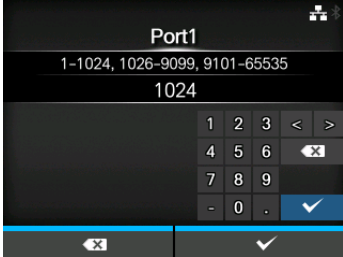

Port2

Interface > Network > Services > Ports > Port2

Set the port number.
The setting range is from 1 to 65535.
Each port (1, 2 and 3) must be set to different values.

Note

This setting is disabled when AEP mode is enabled.

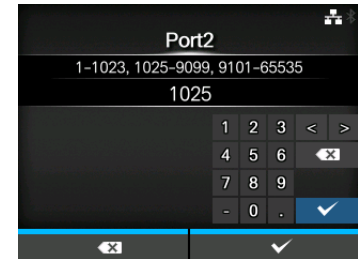

Port3

Interface > Network > Services > Ports > Port3

Set the port number.
The setting range is from 1 to 65535.
Each port (1, 2 and 3) must be set to different values.

Note

You can change the return status format of port3 to legacy status by enabling **Legacy Status for Port 9100**.

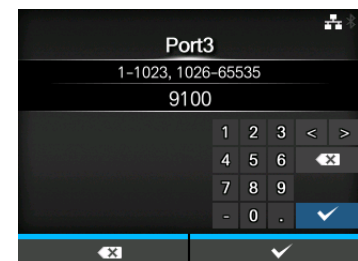

Flow Control

Interface > Network > Services > Ports > Flow Control

Set the communication protocol.
The options are as follows:

- **Status4**
- **Status4 ENQ**
- **Status3**
- **Status5**
- **None**

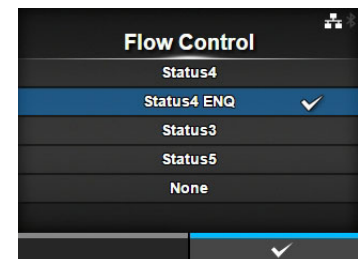

Multiple connections

Interface > Network > Services > Ports > Multiple connections

Set whether to receive connection requests from multiple hosts or applications.

The options are as follows:

- **Enabled:** While connecting with one host or application, the printer can receive connection requests from other hosts or applications. The subsequent connection requests are put on hold, and processed in order of reception after the first connection is closed.
- **Disabled:** While connecting with one host or application, the printer cannot receive connection requests from other hosts or applications.

CAUTION

When you have selected **Enabled**, be sure to use one port connection for Status3, Status4, and Status5. Operation using two port connections for Status4 is not guaranteed.

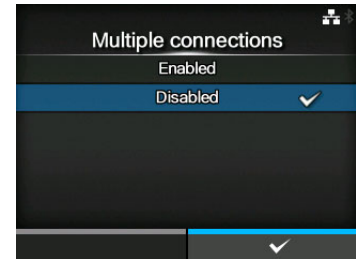

Legacy Status for Port 9100

Interface > Network > Services > Ports > Legacy Status for Port 9100

Set whether to change the return status format of port3 to legacy status.
Does not show if you have selected **None** in the **Flow Control** menu.
The options are as follows:

- **Enabled**: Change the return status format of port3 to legacy status.
- **Disabled**: Do not change the return status format of port3 to legacy status.

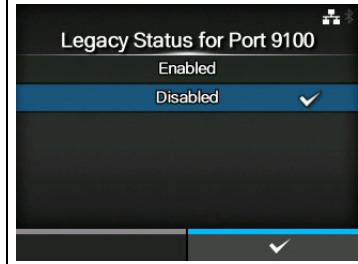

In legacy status, the return status format of port3 becomes as follows:

Status	Legacy status	Data format
Status3	Disabled	ACK/NAK Reply ACK/NAK 1 byte Status Reply STX Status3 ETX 11 bytes
	Enabled	ACK/NAK Reply ACK/NAK 1 byte Status Reply 00 00 00 0b STX Status3 ETX 15 bytes
Status4	Disabled	ACK/NAK Reply 00 00 00 01 ACK/NAK 5 bytes Status Reply 00 00 00 1C ENQ STX Status4 ETX 32 bytes
	Enabled	ACK/NAK Reply ACK/NAK 1 byte Status Reply 00 00 00 20 00 00 00 1C ENQ STX Status4 ETX 36 bytes
Status5	Disabled	ACK/NAK Reply No Reply Status Reply STX Status5 ETX 22 bytes
	Enabled	ACK/NAK Reply No Reply Status Reply 00 00 00 16 STX Status5 ETX 26 bytes

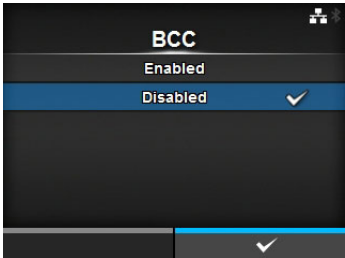
BCC	
<p><i>Interface > Network > Services > Ports > BCC</i></p> <p>Enable or disable the BCC check function. Shows only if you have selected Status5 in the Flow Control menu. The options are as follows:</p> <ul style="list-style-type: none"> • Enabled: Enable the BCC check function. • Disabled: Disable the BCC check function. 	

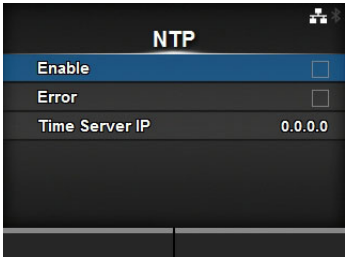
NTP										
<p><i>Interface > Network > Services > NTP</i></p> <p>Set the functions for NTP. The NTP function gets the time information from the NTP server through the network and sets the time of the printer. The setting items are as follows:</p> <table border="1" style="width: 100%; border-collapse: collapse;"> <tr> <td style="width: 5%; text-align: center;">1</td> <td style="width: 20%;">Enable</td> <td>Enable or disable the functions for NTP.</td> </tr> <tr> <td style="text-align: center;">2</td> <td>Error</td> <td>Set to show the NTP error message if detected.</td> </tr> <tr> <td style="text-align: center;">3</td> <td>Time Server IP</td> <td>Set the IP address of the NTP server.</td> </tr> </table>	1	Enable	Enable or disable the functions for NTP.	2	Error	Set to show the NTP error message if detected.	3	Time Server IP	Set the IP address of the NTP server.	
1	Enable	Enable or disable the functions for NTP.								
2	Error	Set to show the NTP error message if detected.								
3	Time Server IP	Set the IP address of the NTP server.								

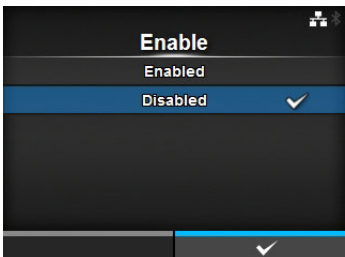
Enable	
<p><i>Interface > Network > Services > NTP > Enable</i></p> <p>Enable or disable the functions for NTP. The options are as follows:</p> <ul style="list-style-type: none"> • Enabled: Enable the NTP function. • Disabled: Disable the NTP function. 	

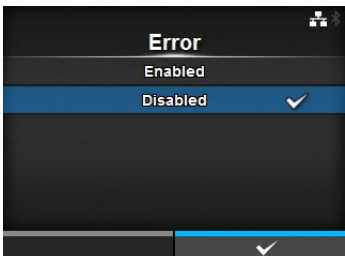
Error	
<p><i>Interface > Network > Services > NTP > Error</i></p> <p>Set to show the NTP error message if detected. The options are as follows:</p> <ul style="list-style-type: none"> • Enabled: Shows the error message. • Disabled: Do not show the error message. 	

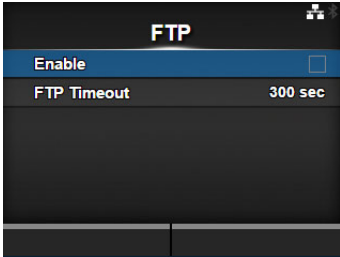
FTP			
<p><i>Interface > Network > Services > FTP</i></p> <p>Set the functions for FTP. The setting items are as follows:</p>			
1	Enable		Enable or disable the functions for FTP.
2	FTP Timeout		Set the connection timeout period between the printer's FTP server and clients.

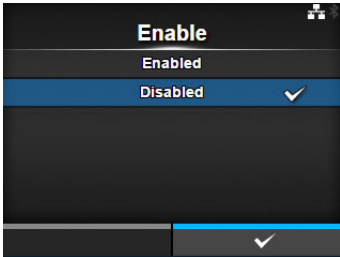
Enable	
<p><i>Interface > Network > Services > FTP > Enable</i></p> <p>Enable or disable the functions for FTP. The options are as follows:</p> <ul style="list-style-type: none"> • Enabled: Enable the FTP function. • Disabled: Disable the FTP function. 	

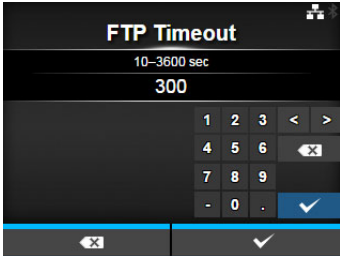
FTP Timeout	
<p><i>Interface > Network > Services > FTP > FTP Timeout</i></p> <p>Set the connection timeout period between the printer's FTP server and clients. Specify the maximum number of seconds that the printer's FTP server will allow clients to stay connected without receiving any data on either the control or data connection. The setting range is from 10 to 3600 seconds.</p>	

SNMP

Interface > Network > Services > SNMP

Set the functions for SNMP.
The SNMP function enables you to monitor and manage a UDP/IP based network.
The setting items are as follows:

1	sysContact	Set the contact information.
2	sysName	Set the name information.
3	sysLocation	Set the location information.
4	prtMarkerCounter Unit	Set the unit to use for reporting counter values for subunits.
5	Agent	Set the Agent function.
6	Traps	Set the Traps function.



sysContact

Interface > Network > Services > SNMP > sysContact

Set the contact information.
You can enter alphabetic, numeric and symbolic characters in the range of 0 to 255 characters.

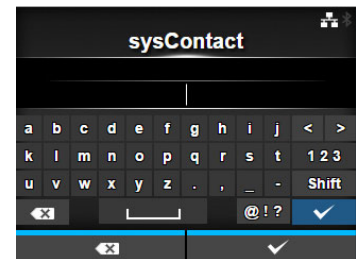



sysName

Interface > Network > Services > SNMP > sysName

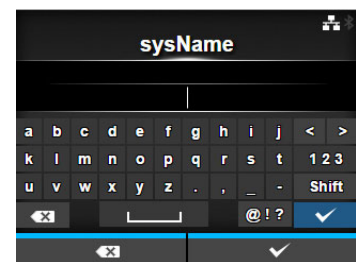
Set the name information.
You can enter alphabetic, numeric and symbolic characters in the range of 0 to 255 characters.

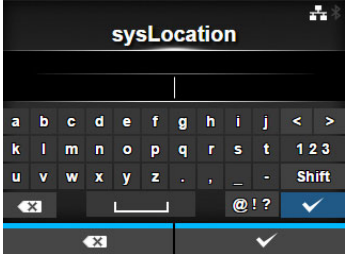

sysLocation	
<p><i>Interface > Network > Services > SNMP > sysLocation</i></p> <p>Set the location information. You can enter alphabetic, numeric and symbolic characters in the range of 0 to 255 characters.</p>	

prtMarkerCounterUnit	
<p><i>Interface > Network > Services > SNMP > prtMarkerCounterUnit</i></p> <p>Set the unit to use for reporting counter values for subunits. The options are follows:</p> <ul style="list-style-type: none"> • impressions: Report the number of printed labels. • meters: Report the length of printed labels in meters. 	

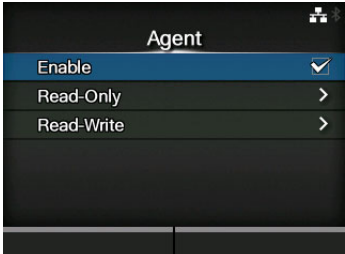
Agent										
<p><i>Interface > Network > Services > SNMP > Agent</i></p> <p>Set the Agent function. The setting items are as follows:</p> <table border="1" style="width: 100%; border-collapse: collapse;"> <tr> <td style="width: 5%; text-align: center;">1</td> <td style="width: 20%;">Enable</td> <td>Use the Agent function.</td> </tr> <tr> <td style="text-align: center;">2</td> <td>Read-Only</td> <td>Set the Read-Only function.</td> </tr> <tr> <td style="text-align: center;">3</td> <td>Read-Write</td> <td>Set the Read-Write function.</td> </tr> </table>	1	Enable	Use the Agent function.	2	Read-Only	Set the Read-Only function.	3	Read-Write	Set the Read-Write function.	
1	Enable	Use the Agent function.								
2	Read-Only	Set the Read-Only function.								
3	Read-Write	Set the Read-Write function.								

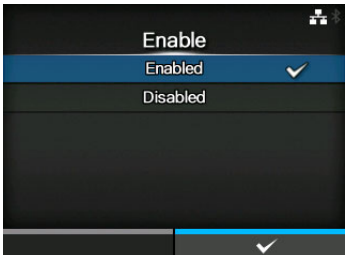
Enable	
<p><i>Interface > Network > Services > SNMP > Agent > Enable</i></p> <p>Enable or disable the functions for Agent. The options are as follows:</p> <ul style="list-style-type: none"> • Enabled: Enable the functions for Agent. • Disabled: Disable the functions for Agent. 	

Read-Only		
<p><i>Interface > Network > Services > SNMP > Agent > Read-Only</i></p> <p>Set the Read-Only function. The setting items are as follows:</p>		
1	SNMP Version	Set the SNMP version.
2	Community	Set the Read-Only community name. *Shows only if you have selected 1 2c 3 or 1 2c in the SNMP Version menu.
3	User	Set the Read-Only user name. *Shows only if you have selected 1 2c 3 or 3 in the SNMP Version menu.
4	User Security	Set the Read-Only security level. *Shows only if you have selected 1 2c 3 or 3 in the SNMP Version menu.
5	Authentication Protocol	Set the authentication protocol. *Shows only if you have selected Authentication or Privacy in the User Security menu.
6	Authentication Passphrase	Set the authentication passphrase. *Shows only if you have selected Authentication or Privacy in the User Security menu.
7	Privacy Protocol	Set the privacy protocol. *Shows only if you have selected Privacy in the User Security menu.
8	Privacy Passphrase	Set the privacy passphrase. *Shows only if you have selected Privacy in the User Security menu.



SNMP Version	
<p><i>Interface > Network > Services > SNMP > Agent > Read-Only > SNMP Version</i></p> <p>Set the SNMP version. The options are as follows:</p> <ul style="list-style-type: none"> • 1 2c 3 • 1 2c • 3 • Disabled 	

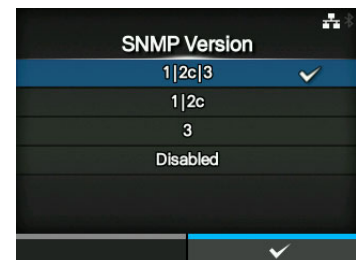

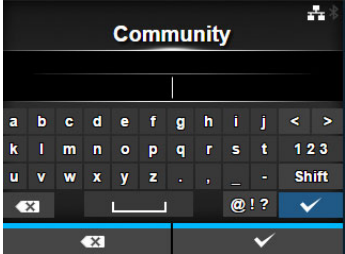
Community	
<p><i>Interface > Network > Services > SNMP > Agent > Read-Only > Community</i></p> <p>Set the Read-Only community name. Shows only if you have selected 1 2c 3 or 1 2c in the SNMP Version menu. You can enter alphabetic, numeric and symbolic characters in the range of 1 to 32 characters. Initial setting: public</p>	

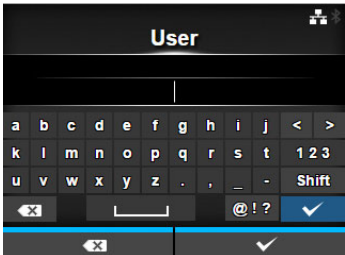
User	
<p><i>Interface > Network > Services > SNMP > Agent > Read-Only > User</i></p> <p>Set the Read-Only user name. Shows only if you have selected 1 2c 3 or 3 in the SNMP Version menu. You can enter alphabetic, numeric and symbolic characters in the range of 1 to 32 characters. Initial setting: rouser</p>	

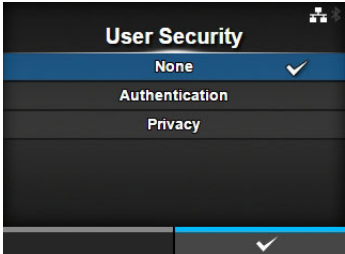
User Security	
<p><i>Interface > Network > Services > SNMP > Agent > Read-Only > User Security</i></p> <p>Set the Read-Only security level. Shows only if you have selected 1 2c 3 or 3 in the SNMP Version menu.</p> <p>The options are as follows:</p> <ul style="list-style-type: none"> • None • Authentication • Privacy 	

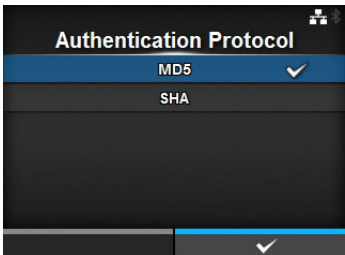
Authentication Protocol	
<p><i>Interface > Network > Services > SNMP > Agent > Read-Only > Authentication Protocol</i></p> <p>Set the authentication protocol. Shows only if you have selected Authentication or Privacy in the User Security menu. The options are as follows:</p> <ul style="list-style-type: none"> • MD5 • SHA 	

Authentication Passphrase

Interface > Network > Services > SNMP > Agent > Read-Only > Authentication Passphrase

Set the authentication passphrase.

Shows only if you have selected **Authentication** or **Privacy** in the **User Security** menu.

You can enter alphabetic, numeric and symbolic characters in the range of 8 to 32 characters.

Initial setting: mypassword

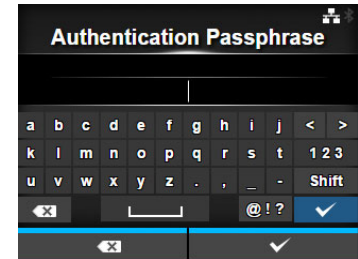

Privacy Protocol

Interface > Network > Services > SNMP > Agent > Read-Only > Privacy Protocol

Set the privacy protocol.

Shows only if you have selected **Privacy** in the **User Security** menu.

The options are as follows:

- **DES**
- **AES**

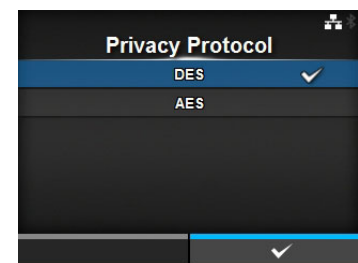

Privacy Passphrase

Interface > Network > Services > SNMP > Agent > Read-Only > Privacy Passphrase

Set the privacy passphrase.

Shows only if you have selected **Privacy** in the **User Security** menu.

You can enter alphabetic, numeric and symbolic characters in the range of 8 to 32 characters.

Initial setting: mypassword



Read-Write		
<p><i>Interface > Network > Services > SNMP > Agent > Read-Write</i></p> <p>Set the Read-Write function. The setting items are as follows:</p>		
1	SNMP Version	Set the SNMP version.
2	Community	Set the Read-Write community name. *Shows only if you have selected 1 2c 3 or 1 2c in the SNMP Version menu.
3	User	Set the Read-Write user name. *Shows only if you have selected 1 2c 3 or 3 in the SNMP Version menu.
4	User Security	Set the Read-Write security level. *Shows only if you have selected 1 2c 3 or 3 in the SNMP Version menu.
5	Authentication Protocol	Set the authentication protocol. *Shows only if you have selected Authentication or Privacy in the User Security menu.
6	Authentication Passphrase	Set the authentication passphrase. *Shows only if you have selected Authentication or Privacy in the User Security menu.
7	Privacy Protocol	Set the privacy protocol. *Shows only if you have selected Privacy in the User Security menu.
8	Privacy Passphrase	Set the privacy passphrase. *Shows only if you have selected Privacy in the User Security menu.

SNMP Version	
<p><i>Interface > Network > Services > SNMP > Agent > Read-Write > SNMP Version</i></p> <p>Set the SNMP version. The options are as follows:</p> <ul style="list-style-type: none"> • 1 2c 3 • 1 2c • 3 • Disabled 	

Community

Interface > Network > Services > SNMP > Agent > Read-Write > Community

Set the Read-Write community name.

Shows only if you have selected **1|2c|3** or **1|2c** in the **SNMP Version** menu.

You can enter alphabetic, numeric and symbolic characters in the range of 1 to 32 characters.

Initial setting: private



User

Interface > Network > Services > SNMP > Agent > Read-Write > User

Set the Read-Write user name.

Shows only if you have selected **1|2c|3** or **3** in the **SNMP Version** menu.

You can enter alphabetic, numeric and symbolic characters in the range of 1 to 32 characters.

Initial setting: rwuser



User Security

Interface > Network > Services > SNMP > Agent > Read-Write > User Security

Set the Read-Write security level.

Shows only if you have selected **1|2c|3** or **3** in the **SNMP Version** menu.

The options are as follows:

- **None**
- **Authentication**
- **Privacy**

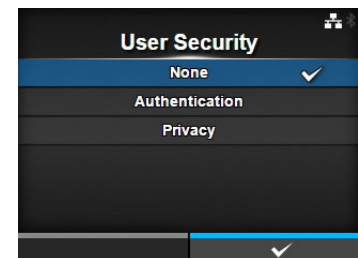

Authentication Protocol

Interface > Network > Services > SNMP > Agent > Read-Write > Authentication Protocol

Set the authentication protocol.

Shows only if you have selected **Authentication** or **Privacy** in the **User Security** menu.

The options are as follows:

- **MD5**
- **SHA**

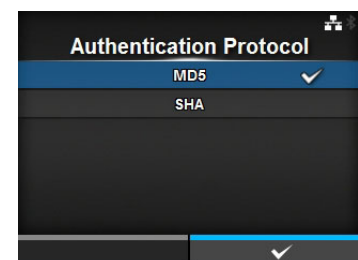

Authentication Passphrase	
<p><i>Interface > Network > Services > SNMP > Agent > Read-Write > Authentication Passphrase</i></p> <p>Set the authentication passphrase. Shows only if you have selected Authentication or Privacy in the User Security menu. You can enter alphabetic, numeric and symbolic characters in the range of 8 to 32 characters. Initial setting: mypassword</p>	

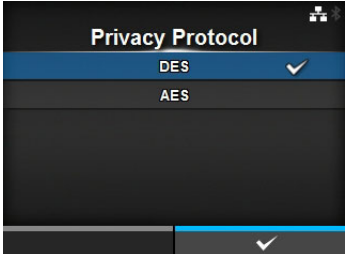
Privacy Protocol	
<p><i>Interface > Network > Services > SNMP > Agent > Read-Write > Privacy Protocol</i></p> <p>Set the privacy protocol. Shows only if you have selected Privacy in the User Security menu. The options are as follows:</p> <ul style="list-style-type: none">• DES• AES	

Privacy Passphrase	
<p><i>Interface > Network > Services > SNMP > Agent > Read-Write > Privacy Passphrase</i></p> <p>Set the privacy passphrase. Shows only if you have selected Privacy in the User Security menu. You can enter alphabetic, numeric and symbolic characters in the range of 8 to 32 characters. Initial setting: mypassword</p>	

Traps		
<p><i>Interface > Network > Services > SNMP > Traps</i></p> <p>Set the Traps function. The setting items are as follows:</p>		
1	Enable	Use the Traps function.
2	SNMP Version	Set the SNMP version.
3	IP Version	Set the IP version.
4	Destinations	Set the number of trap destinations.
5	Destination 1	Set address 1 for the trap destination.
6	Destination 2	Set address 2 for the trap destination. *Shows only if you have selected 2 or 3 in the Destinations menu.
7	Destination 3	Set address 3 for the trap destination. *Shows only if you have selected 3 in the Destinations menu.
8	Community	Set the Traps community name. *Shows only if you have selected 1 or 2c in the SNMP Version menu.
9	User	Set the Traps user name. *Shows only if you have selected 3 in the SNMP Version menu.
10	Engine ID	Set the engine ID. *Shows only if you have selected 3 in the SNMP Version menu.
11	Security	Set the security level. *Shows only if you have selected 3 in the SNMP Version menu.
12	Authentication Protocol	Set the authentication protocol. *Shows only if you have selected Authentication or Privacy in the Security menu.
13	Authentication Passphrase	Set the authentication passphrase. *Shows only if you have selected Authentication or Privacy in the Security menu.
14	Privacy Protocol	Set the privacy protocol. *Shows only if you have selected Privacy in the Security menu.
15	Privacy Passphrase	Set the privacy passphrase. *Shows only if you have selected Privacy in the Security menu.

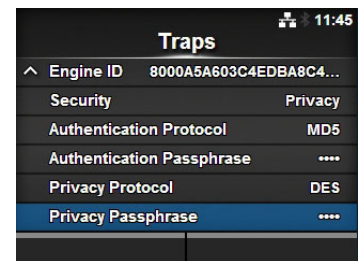
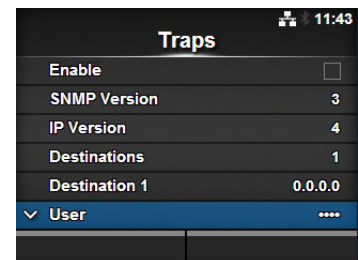
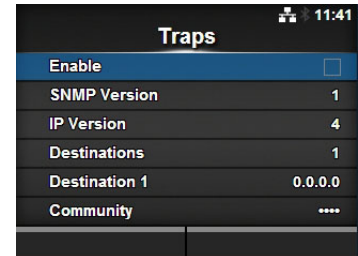

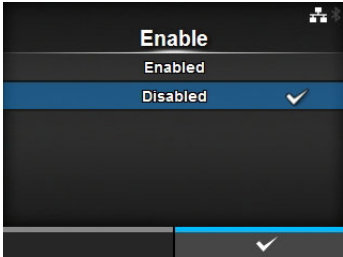
Enable	
<p><i>Interface > Network > Services > SNMP > Traps > Enable</i></p> <p>Enable or disable the functions for Traps. The options are as follows:</p> <ul style="list-style-type: none">• Enabled: Enable the Traps function.• Disabled: Disable the Traps function.	

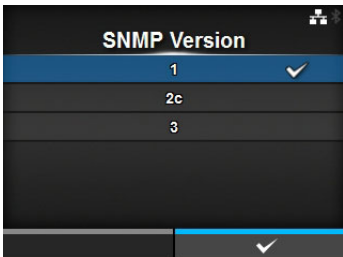
SNMP Version	
<p><i>Interface > Network > Services > SNMP > Traps > SNMP Version</i></p> <p>Set the SNMP version. The options are as follows:</p> <ul style="list-style-type: none">• 1• 2c• 3	

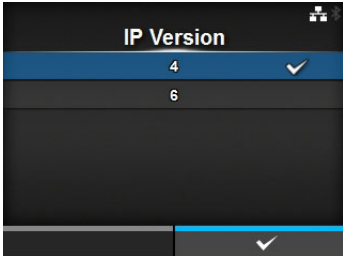
IP Version	
<p><i>Interface > Network > Services > SNMP > Traps > IP Version</i></p> <p>Set the IP version to use for trap destinations. The options are as follows:</p> <ul style="list-style-type: none">• 4: Set the IP version to IPv4.• 6: Set the IP version to IPv6.	

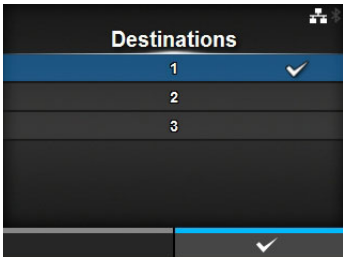
Destinations	
<p><i>Interface > Network > Services > SNMP > Traps > Destinations</i></p> <p>Set the number of trap destinations. The setting range is from 1 to 3.</p>	

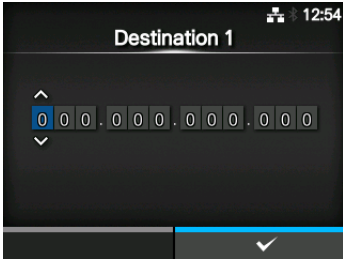
Destination 1	
<p><i>Interface > Network > Services > SNMP > Traps > Destination 1</i></p> <p>Set address 1 for trap destination. The displayed IP version differs depending on the IP Version setting.</p>	

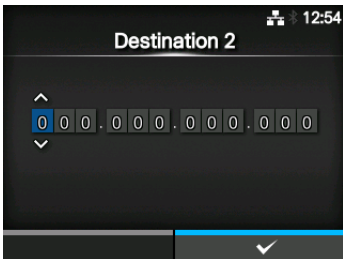
Destination 2	
<p><i>Interface > Network > Services > SNMP > Traps > Destination 2</i></p> <p>Set address 2 for trap destination. The displayed IP version differs depending on the IP Version setting. Shows only if you have selected 2 or 3 in the Destinations menu.</p>	

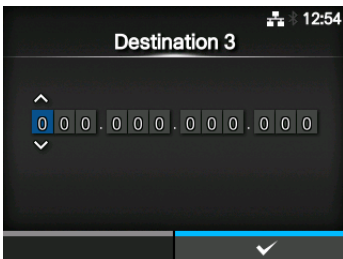
Destination 3	
<p><i>Interface > Network > Services > SNMP > Traps > Destination 3</i></p> <p>Set address 3 for trap destination. The displayed IP version differs depending on the IP Version setting. Shows only if you have selected 3 in the Destinations menu.</p>	

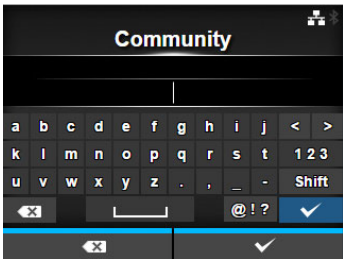
Community	
<p><i>Interface > Network > Services > SNMP > Traps > Community</i></p> <p>Set the Traps community name. Shows only if you have selected 1 or 2c in the SNMP Version menu. You can enter alphabetic, numeric and symbolic characters in the range of 1 to 32 characters. Initial setting: trapcom</p>	

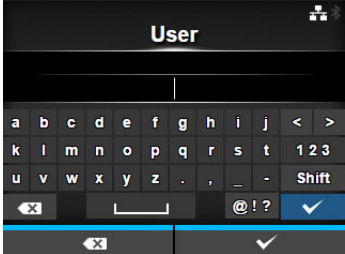
User	
<p><i>Interface > Network > Services > SNMP > Traps > User</i></p> <p>Set the Traps user name. Shows only if you have selected 3 in the SNMP Version menu. You can enter alphabetic, numeric and symbolic characters in the range of 1 to 32 characters. Initial setting: trapuser</p>	

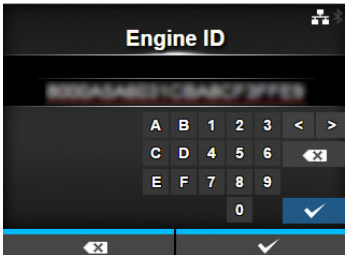
Engine ID	
<p><i>Interface > Network > Services > SNMP > Traps > Engine ID</i></p> <p>Set the engine ID. Shows only if you have selected 3 in the SNMP Version menu. Initial setting: Created from the MAC address.</p> <p>Hexadecimal characters are allowed and the range is from 10 to 64 characters (only an even number of characters are allowed).</p>	

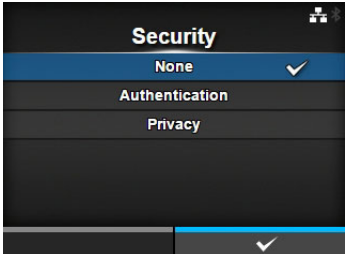
Security	
<p><i>Interface > Network > Services > SNMP > Traps > Security</i></p> <p>Set the security level. Shows only if you have selected 3 in the SNMP Version menu. The options are as follows:</p> <ul style="list-style-type: none"> • None • Authentication • Privacy 	

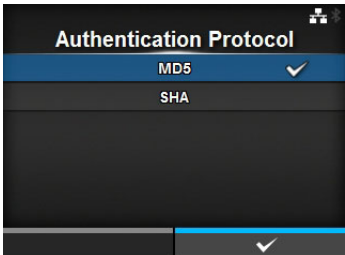
Authentication Protocol	
<p><i>Interface > Network > Services > SNMP > Traps > Authentication Protocol</i></p> <p>Set the authentication protocol. Shows only if you have selected Authentication or Privacy in the Security menu. The options are as follows:</p> <ul style="list-style-type: none"> • MD5 • SHA 	

Authentication Passphrase

Interface > Network > Services > SNMP > Traps > Authentication Passphrase

Set the authentication passphrase.

Shows only if you have selected **Authentication** or **Privacy** in the **Security** menu.

You can enter alphabetic, numeric and symbolic characters in the range of 8 to 32 characters.

Initial setting: mypassword



Privacy Protocol

Interface > Network > Services > SNMP > Traps > Privacy Protocol

Set the privacy protocol.

Shows only if you have selected **Privacy** in the **Security** menu.

The options are as follows:

- **DES**
- **AES**

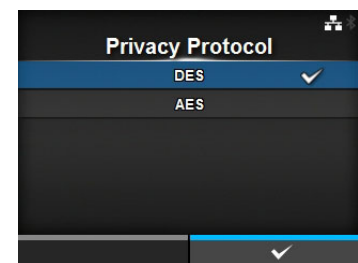

Privacy Passphrase

Interface > Network > Services > SNMP > Traps > Privacy Passphrase

Set the privacy passphrase.

Shows only if you have selected **Privacy** in the **Security** menu.

You can enter alphabetic, numeric and symbolic characters in the range of 8 to 32 characters.

Initial setting: mypassword

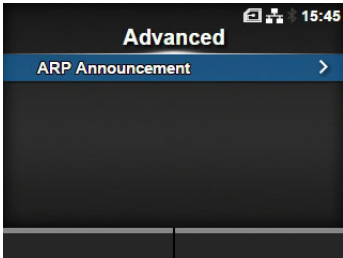

Advanced		
<p><i>Interface > Network > Advanced</i></p> <p>Set the advanced function for the interface. The setting item is as follows:</p>		
1	ARP Announcement	

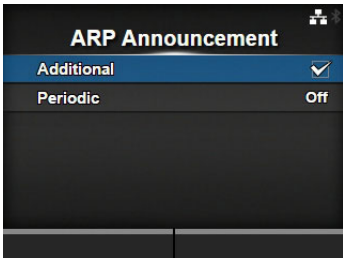
ARP Announcement			
<p><i>Interface > Network > Advanced > ARP Announcement</i></p> <p>Set the functions for ARP announcement. The ARP announcement is useful for updating other hosts mapping of a hardware address when the IP address or MAC address of the sender has changed. The setting items are as follows:</p>			
1	Additional		Enable or disable the additional ARP announcement.
2	Periodic		Set the periodic timing for ARP announcement.

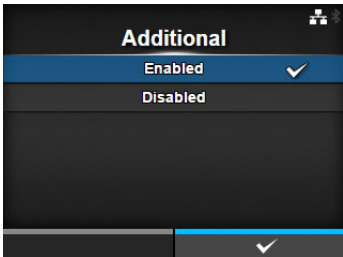
Additional		
<p><i>Interface > Network > Advanced > ARP Announcement > Additional</i></p> <p>Set the additional ARP announcement. The options are as follows:</p> <ul style="list-style-type: none"> • Enabled: Enable the additional ARP announcement. The ARP is sent at 1, 2, 4, 8 and 16 seconds after the link up/DHCP assignment. • Disabled: Disable the additional ARP announcement. The ARP is only sent at 1 second after the link up/DHCP assignment. 		

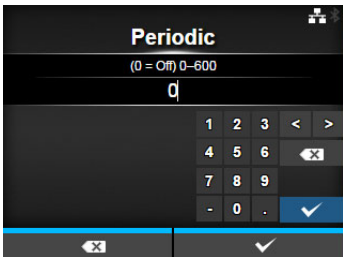
Periodic		
<p><i>Interface > Network > Advanced > ARP Announcement > Periodic</i></p> <p>Set the interval of the ARP announcement in the range of 0 to 600 seconds. Initial setting: 0</p>		

IEEE1284

Interface > IEEE1284

Set the IEEE1284 connection.
Shows only if the combo interface board is installed.
The setting items are as follows:

1	Flow Control	Set the communication protocol.
2	BCC	Set the BCC check function. *Shows only if you have selected Status5 in the Flow Control menu.

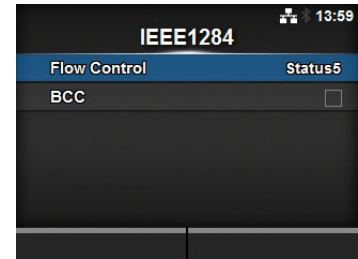

Flow Control

Interface > IEEE1284 > Flow Control

Set the communication protocol.
The options are as follows:

- **Status4 Multi**
- **Status5**
- **None**

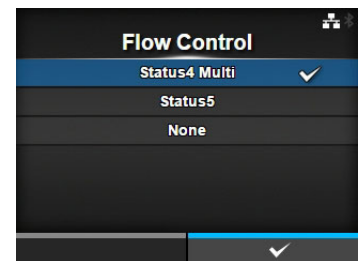

BCC

Interface > IEEE1284 > BCC

Enable or disable the BCC check function.
Shows only if you have selected **Status5** in the **Flow Control** menu.
The options are as follows:

- **Enabled**: Enable the BCC check function.
- **Disabled**: Disable the BCC check function.

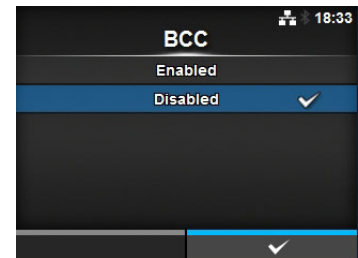

RS-232C		
<p><i>Interface > RS-232C</i></p> <p>Set the RS-232C connection. Shows only if the combo interface board is installed. The setting items are as follows:</p>		
1	Interface	Set the RS-232C interface usage.
2	Baudrate	Set the communication speed.
3	Parameters	Set the data parameters.
4	Flow Control	Set the communication protocol.
5	BCC	Set the BCC check function. *Shows only if you have selected STATUS5 in the Flow Control menu.
<p>Note When Interface is set to RS-232C Reader, you cannot change Baudrate, Parameters, Flow Control or BCC.</p>		

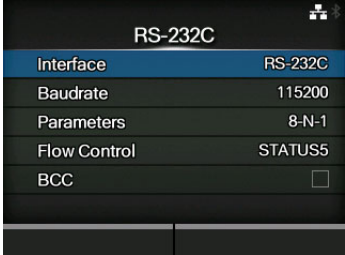

Interface	
<p><i>Interface > RS-232C > Interface</i></p> <p>Set the RS-232C interface usage. The options are as follows:</p> <ul style="list-style-type: none"> • RS-232C: Use the RS-232C interface for communicating with computers. • RS-232C Reader: Select this when you connect the barcode checker to the RS-232C connector of the printer for the barcode check function. 	
<p>Note The message prompting to restart the printer will appear on the online/ offline screen if you have made any changes. In such a case, reboot the printer to make the setting effective.</p>	

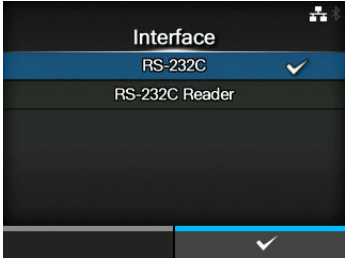

Baudrate	
<p><i>Interface > RS-232C > Baudrate</i></p> <p>Set the baud rate (bps). Available to change only if you have selected RS-232C in the Interface menu. The options are as follows:</p> <ul style="list-style-type: none"> • 2400 • 4800 • 9600 • 19200 • 38400 • 57600 • 115200 	

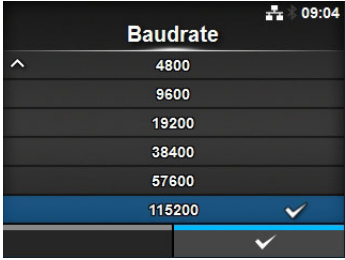

Parameters

Interface > RS-232C > Parameters

Set the data parameter.

Available to change only if you have selected **RS-232C** in the **Interface** menu.

The options are as follows:

Refer to the table below for the parameter configurations.

- 8-N-1
- 8-O-1
- 8-E-1
- 8-N-2
- 8-O-2
- 8-E-2
- 7-N-1
- 7-O-1
- 7-E-1
- 7-N-2
- 7-O-2
- 7-E-2

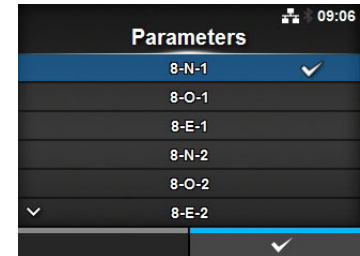

Parameter Configurations List

Parameter	Data length (bit)	Parity	Stop bit (bit)
8-N-1	8	NONE	1
8-O-1	8	ODD	1
8-E-1	8	EVEN	1
8-N-2	8	NONE	2
8-O-2	8	ODD	2
8-E-2	8	EVEN	2
7-N-1	7	NONE	1
7-O-1	7	ODD	1
7-E-1	7	EVEN	1
7-N-2	7	NONE	2
7-O-2	7	ODD	2
7-E-2	7	EVEN	2

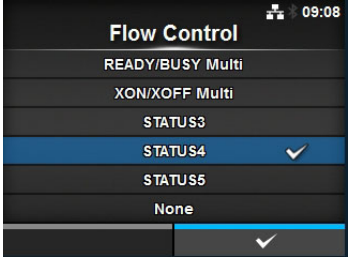
Flow Control	
<p><i>Interface > RS-232C > Flow Control</i></p> <p>Set the communication protocol. Available to change only if you have selected RS-232C in the Interface menu.</p> <p>The options are as follows:</p> <ul style="list-style-type: none"> • READY/BUSY Multi • XON/XOFF Multi • STATUS3 • STATUS4 • STATUS5 • None 	

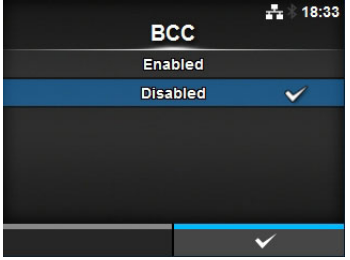
BCC	
<p><i>Interface > RS-232C > BCC</i></p> <p>Enable or disable the BCC check function. Shows only if you have selected RS-232C in the Interface menu and if you have selected STATUS5 in the Flow Control menu.</p> <p>The options are as follows:</p> <ul style="list-style-type: none"> • Enabled: Enable the BCC check function. • Disabled: Disable the BCC check function. 	

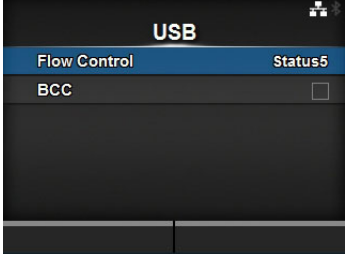
USB		
<p><i>Interface > USB</i></p> <p>Set the USB connection. The setting items are as follows:</p>		
1	Flow Control	Set the communication protocol.
2	BCC	Set the BCC check function. *Shows only if you have selected Status5 in the Flow Control menu.
		

Flow Control	
<p><i>Interface > USB > Flow Control</i></p> <p>Set the communication protocol. The options are as follows:</p> <ul style="list-style-type: none"> • Status4 • Status5 • None 	

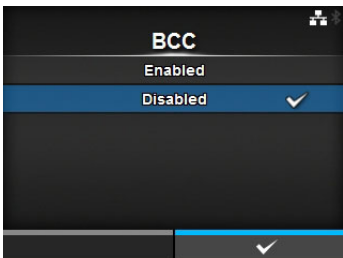
BCC	
<p><i>Interface > USB > BCC</i></p> <p>Enable or disable the BCC check function. Shows only if you have selected Status5 in the Flow Control menu. The options are as follows:</p> <ul style="list-style-type: none"> • Enabled: Enable the BCC check function. • Disabled: Disable the BCC check function. 	

Bluetooth		
<i>Interface > Bluetooth</i>		
Set the Bluetooth connection. The setting items are as follows:		
1	Enable	Enable or disable the functions for Bluetooth.
2	Name	Set the device name for the printer.
3	PIN Code	Set the PIN code.
4	BD Address	Shows the BD address of this printer. (You cannot change this address.)
5	Firm Version	Shows the firmware version of the Bluetooth. (You cannot change this value.)
6	Host BD Addr	Check the Host BD address.
7	Authentication	Set the authentication level.
8	ISI	Set the ISI communication parameter.
9	ISW	Set the ISW communication parameter.
10	PSI	Set the PSI communication parameter.
11	PSW	Set the PSW communication parameter.
12	CRC Mode	Set the CRC check function.
13	Flow Control	Set the communication protocol.

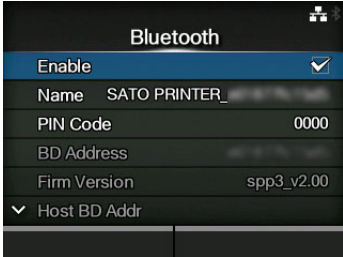

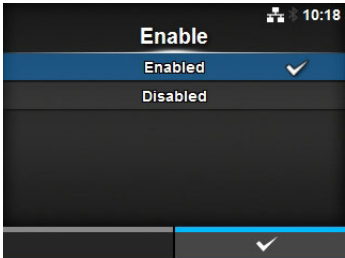
Enable	
<p><i>Interface > Bluetooth > Enable</i></p> <p>Enable or disable the functions for Bluetooth. The options are as follows:</p> <ul style="list-style-type: none"> • Enabled: Enable the Bluetooth function. • Disabled: Disable the Bluetooth function. 	

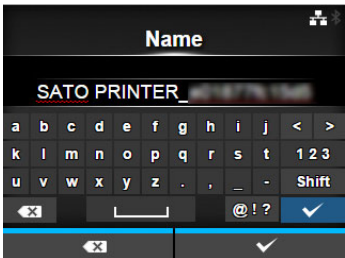
Name	
<p><i>Interface > Bluetooth > Name</i></p> <p>Set the device name for the printer. You can enter one to fifty-three characters including alphabet (upper case and lower case), numbers and symbols.</p>	

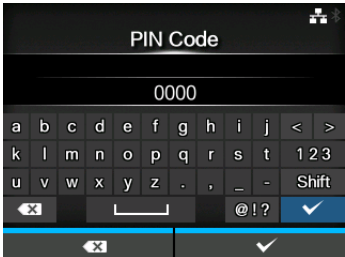
PIN Code	
<p><i>Interface > Bluetooth > PIN Code</i></p> <p>Set the PIN code. You can enter four to sixteen characters including alphabet (upper case and lower case), numbers and symbols.</p>	

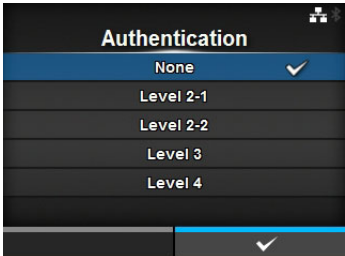
Authentication	
<p><i>Interface > Bluetooth > Authentication</i></p> <p>Set the authentication level. The options are as follows:</p> <ul style="list-style-type: none"> • None: No authentication • Level 2-1: PIN code authentication, service level, no encryption • Level 2-2: PIN code authentication, service level, encryption • Level 3: PIN code authentication, link level, no encryption • Level 4: Secure Simple Pairing compatible, service level, encryption (Can be communicated with devices that are not compatible with Secure Simple Pairing) 	

ISI*Interface > Bluetooth > ISI*

Set the ISI communication parameter.
 The setting range is from 18 to 4096.
 Set to a value that is higher than the ISW communication parameter setting value.

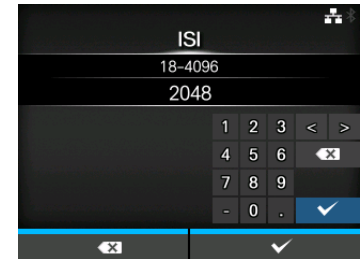
**ISW***Interface > Bluetooth > ISW*

Set the ISW communication parameter.
 The setting range is 0, or from 17 to 4096.
 The setting range varies depending on the ISI communication parameter setting value.
 Set to a value that is less than the ISI communication parameter setting value.

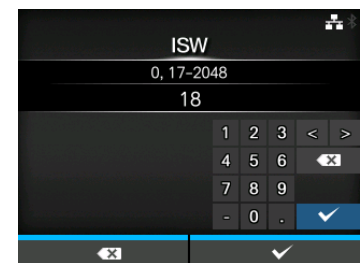
**PSI***Interface > Bluetooth > PSI*

Set the PSI communication parameter.
 The setting range is from 18 to 4096.
 Set to a value that is higher than the PSW communication parameter setting value.

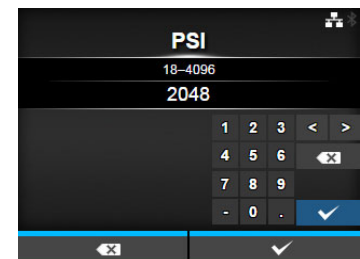
**PSW***Interface > Bluetooth > PSW*

Set the PSW communication parameter.
 The setting range is from 17 to 4096.
 The setting range varies depending on the PSI communication parameter setting value.
 Set to a value that is less than the PSI communication parameter setting value.

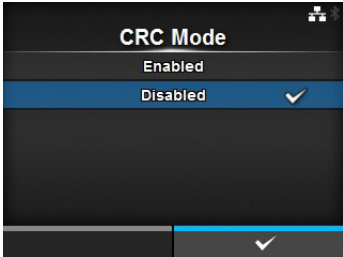

CRC Mode	
<p><i>Interface > Bluetooth > CRC Mode</i></p> <p>Enable or disable the CRC check function. The options are as follows:</p> <ul style="list-style-type: none"> • Enabled: Enable the CRC check function. • Disabled: Disable the CRC check function. 	

Flow Control	
<p><i>Interface > Bluetooth > Flow Control</i></p> <p>Set the communication protocol. The options are as follows:</p> <ul style="list-style-type: none"> • Status3 • Status4 Multi • None 	

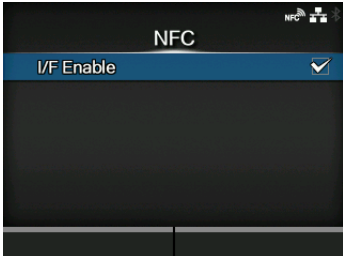
NFC				
<p><i>Interface > NFC</i></p> <p>Set the NFC connection. The setting item is as follows:</p> <table border="1" style="width: 100%; border-collapse: collapse;"> <tr> <td style="width: 5%; text-align: center;">1</td> <td style="width: 20%;">I/F Enable</td> <td>Enable or disable the NFC interface.</td> </tr> </table> <p>Note This feature is supported on printers from serial number 6B~ and above.</p>	1	I/F Enable	Enable or disable the NFC interface.	
1	I/F Enable	Enable or disable the NFC interface.		

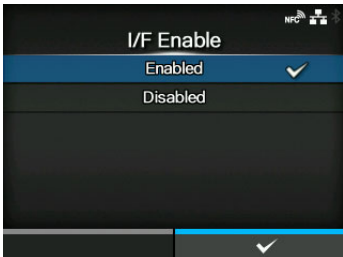
I/F Enable	
<p><i>Interface > NFC > I/F Enable</i></p> <p>Enable or disable the NFC interface. The options are as follows:</p> <ul style="list-style-type: none"> • Enabled: Enable the NFC interface. • Disabled: Disable the NFC interface. 	

Ignore CR/LF

Interface > Ignore CR/LF

Set whether to ignore the CR/LF code (0x0D 0x0A) in the received data.
The options are as follows:

- **Enabled:** Ignore the CR/LF code.
- **Disabled:** Do not ignore the CR/LF code.

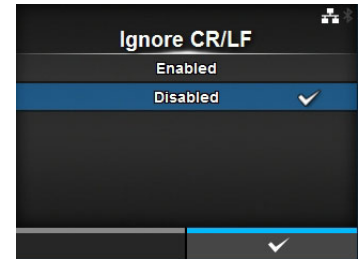

Ignore CAN/DLE

Interface > Ignore CAN/DLE

Set whether to ignore the CAN/DLE code (0x10 / 0x18) in the received data.
The options are as follows:

- **Enabled:** Ignore the CAN/DLE code.
- **Disabled:** Do not ignore the CAN/DLE code.

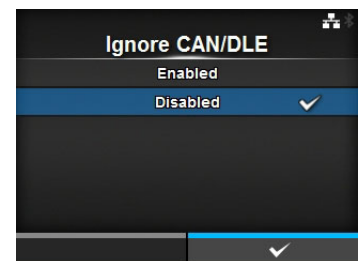

External I/O

Interface > External I/O

Use the external (EXT) terminal as an interface between the external device and the printer.
Shows only if the combo interface board is installed.
The setting items are as follows:

1	Enable	Enable or disable the external signal interface.
2	Signals	Set the external signal. *Shows only if you have selected Enabled in the Enable menu.
3	EXT I/O Re-print	Set the reprint function that uses the external terminal.

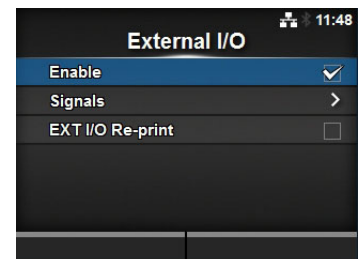

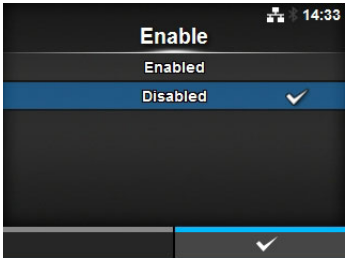
Enable	
<p><i>Interface > External I/O > Enable</i></p> <p>Enable or disable the external signal interface. The options are as follows:</p> <ul style="list-style-type: none"> • Enabled: Enable the external signal interface. • Disabled: Disable the external signal interface. 	

Signals		
<p><i>Interface > External I/O > Signals</i></p> <p>Set the external signal. Shows only if you have selected Enabled in the Enable menu. The setting items are as follows:</p>		
1	EXT 9PIN	Set the function of the EXT 9PIN output.
2	EXT Mode	Set the mode of the Print End Signal.
3	Inputs	Set the input pin No. of the Signal Print Start/Signal Reprint.
4	Outputs	Set the output pin No. of the signals.

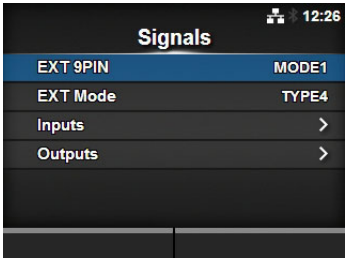

EXT 9PIN	
<p><i>Interface > External I/O > Signals > EXT 9PIN</i></p> <p>Set the function of the EXT 9PIN output. The options are as follows:</p> <ul style="list-style-type: none"> • MODE1: The output signal becomes “Active” only when there is data in print buffer and printer is ONLINE. • MODE2: The output signal becomes “Active” when printer is ONLINE regardless of print data in buffer. 	

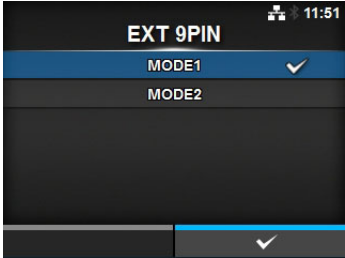

EXT Mode

Interface > External I/O > Signals > EXT Mode

Set the mode of the Print End Signal.
The options are as follows:

Type	Operation Details
TYPE1	The print end signal (PREND) is High before label printing, and it becomes Low after print completion. The signal level becomes High after 20 ms.
TYPE2	The print end signal (PREND) is Low before label printing, and it becomes High after print completion. The signal level becomes Low after 20 ms.
TYPE3	The print end signal (PREND) is High before label printing, becomes Low from the start to the end of print, and becomes High again after print completion.
TYPE4	The print end signal (PREND) is Low before label printing, becomes High from the start to the end of print, and becomes Low again after print completion.

*Refer to [Section 7.8.7 External Signal Interface \(EXT\)](#) for the [Timing Chart of the EXT Output Signal](#).

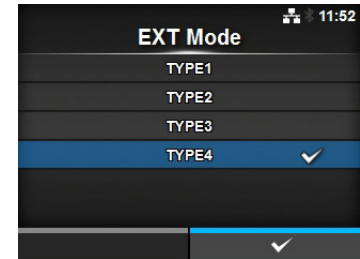

Inputs		
<p><i>Interface > External I/O > Signals > Inputs</i></p> <p>Set the input pin No. of the Signal Print Start/Signal Reprint. Press the ▲/▼ buttons to highlight the item that you want to change, then press the ◀/▶ buttons to change the pin No. Press the ⬅ button to save the settings and return to the Signals menu. The setting items are as follows:</p>		
1	Start Print	Set the input pin No. of the Signal Print Start. The options are as follows: <ul style="list-style-type: none"> • PIN 5: Set the Signal Print Start to pin 5. • PIN 7: Set the Signal Print Start to pin 7.
2	Reprint	Set the input pin No. of the Signal Reprint. The options are as follows: <ul style="list-style-type: none"> • PIN 5: Set the Signal Reprint to pin 5. • PIN 7: Set the Signal Reprint to pin 7.
<p>Note You cannot set any inputs using the same pin number. If you attempt to set the same number, the settings will show in red and you cannot save the settings.</p>		

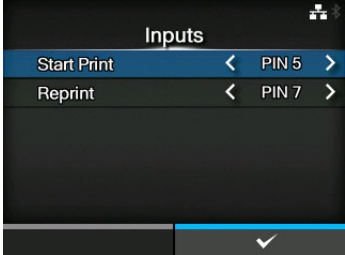

The screenshot shows a dark-themed menu titled 'Inputs'. It contains two items: 'Start Print' and 'Reprint'. 'Start Print' is highlighted in blue and has '< PIN 5 >' next to it. 'Reprint' has '< PIN 7 >' next to it. At the bottom of the screen, there is a navigation bar with a checkmark icon.

Outputs		
<p><i>Interface > External I/O > Signals > Outputs</i></p> <p>Set the output pin No. of the signals.</p> <p>Press the ▲/▼ buttons to highlight the item that you want to change, then press the ◀/▶ buttons to change the pin No.</p> <p>Press the ⬅ button to save the settings and return to the Signals menu.</p> <p>The setting items are as follows:</p>		
1	Paper End/ Paper/Ribbon End (If RFID Mode is enabled) (CL4NX only)	Set the output pin No. of the Signal Paper End. Set the output pin No. of the Signal Paper/ Ribbon End if you have installed the RFID.
2	Ribbon End/ RFID Tag Error (If RFID Mode is enabled) (CL4NX only)	Set the output pin No. of the Signal Ribbon End. Set the output pin No. of the Signal RFID Tag Error if you have installed the RFID.
3	Machine Error/ Machine/RFID Error (If RFID Mode is enabled) (CL4NX only)	Set the output pin No. of the Signal Machine Error. Set the output pin No. of the Signal Machine/ RFID Error if you have installed the RFID.
4	Print Done	Set the output pin No. of the Signal Print End.
5	Qty/Offline	<ul style="list-style-type: none"> • MODE1: The output signal becomes “Active” when there is remaining print data without error in online mode. • MODE2: The output signal becomes “Active” when the printer is Online.
6	Ribbon Near End	Set the output pin No. of the Signal Ribbon Near End.
7	Dispenser	Set the output pin No. of the Signal Dispenser. *To use this signal, connect the dispenser unit or linerless cutter kit (CL4NX only).
8	Label Near End	Set the output pin No. of the Signal Label Near End. *This feature is supported on printers from serial number 6B~ and above.
<p>The options for each signal output are as follows:</p> <ul style="list-style-type: none"> • PIN 1: Set the selected signal to pin 1. • PIN 3: Set the selected signal to pin 3. • PIN 4: Set the selected signal to pin 4. • PIN 6: Set the selected signal to pin 6. • PIN 9: Set the selected signal to pin 9. • PIN 10: Set the selected signal to pin 10. • OFF: Set the selected signal to off mode. 		
<p>Note</p> <p>You cannot set any outputs using the same pin number. If you attempt to set the same number, the settings will show in red and you cannot save the settings.</p>		

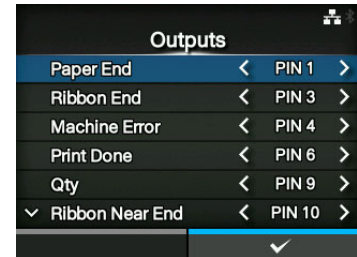

(If RFID Mode is enabled)
(CL4NX only)

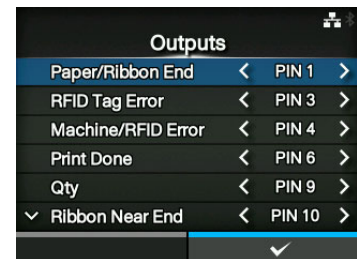

EXT I/O Re-print

Interface > External I/O > EXT I/O Re-print

Set the reprint function for use with the external terminal.

The options are as follows:

- **Enabled:** Enable the reprint function.
- **Disabled:** Disable the reprint function.

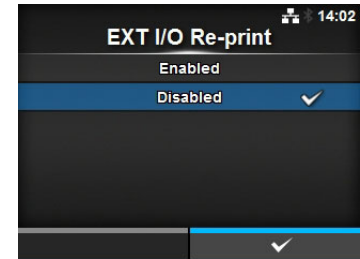

RFID (CL4NX only)		
<p><i>Interface > RFID</i></p> <p>Perform the RFID settings. *Shows only for the RFID model.</p> <p>The setting items are as follows:</p>		
1	Antenna Pitch	Set the antenna pitch.
2	Write Power	Set radio power level used to write information to RFID tag.
3	Read Power	Set radio power level used to read information from RFID tag.
4	Tag Offset	Set distance to print on label BEFORE pausing to encode RFID.
5	Reader Model	Shows the RFID module model.
6	Reader Version	Shows the RFID module firmware version.
7	View	Shows the RFID tag data.
8	Retry Mode	Set whether to retry encoding of failed data when an RFID error occurs.
9	Retries	Set the number of failed encoding attempts before error warning/print pause.
10	Mark bad tags	Set the error print for the RFID tag error.
11	MCS	Set the Multi vendor Chip-based Serialization.
12	Non-RFID Warning	Set the non-RFID warning message.
13	Log RFID Data	Set the log function to record the encoded tag information.
14	Data To Record	Set the data to be recorded.
15	Output Error Mode	Set the signal type for RFID errors.
16	Pulse Length	Set the length of an RFID error pulse. *Shows only if you have selected Pulse in the Output Error Mode menu.
17	Counters	Shows the RFID counter.

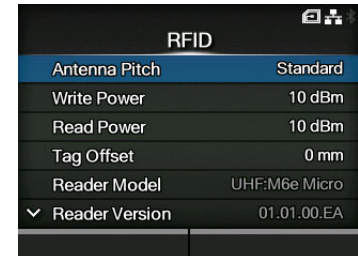

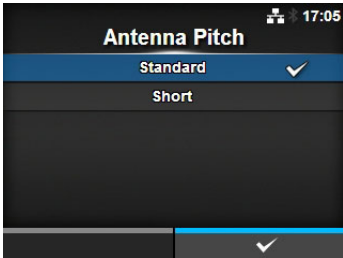
Antenna Pitch	UHF
<p><i>Interface > RFID > Antenna Pitch</i></p> <p>Set the antenna pitch according to the Inlay Configuration Guide. For details, access the following URL: http://www.satoworldwide.com/rfid/</p> <p>The options are as follows:</p> <ul style="list-style-type: none"> • Standard • Short <p>*Shows only if the module is UHF.</p>	

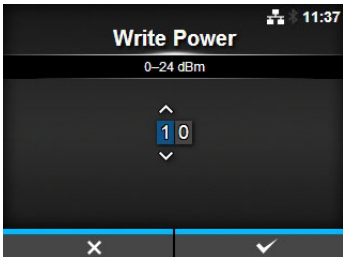
Write Power	UHF
<p><i>Interface > RFID > Write Power</i></p> <p>Set radio power level used to write information to RFID tag according to the Inlay Configuration Guide. For details, access the following URL: http://www.satoworldwide.com/rfid/</p> <p>The setting range is from 0 to 24 dBm.</p> <p>*Shows only if the module is UHF.</p>	

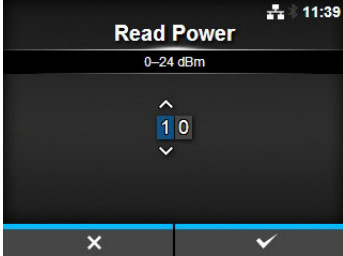
Read Power	UHF
<p><i>Interface > RFID > Read Power</i></p> <p>Set radio power level used to read information from RFID tag according to the Inlay Configuration Guide. For details, access the following URL: http://www.satoworldwide.com/rfid/</p> <p>The setting range is from 0 to 24 dBm.</p> <p>*Shows only if the module is UHF.</p>	

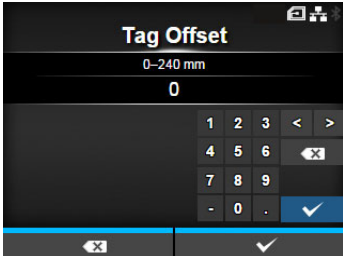
Tag Offset	UHF HF
<p><i>Interface > RFID > Tag Offset</i></p> <p>Set distance to print on label BEFORE pausing to encode RFID according to the Inlay Configuration Guide. This setting will be used when labels are not compatible with the CL4NX's antenna positions. For details, access the following URL: http://www.satoworldwide.com/rfid/</p> <p>The setting range is from 0 to 240 mm.</p>	

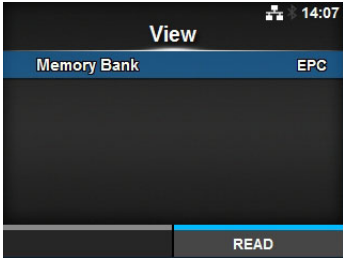
View UHF HF	
<p><i>Interface > RFID > View</i></p> <p>Shows the data of the RFID tag.</p> <p>Press the ← button to change to the Memory Bank screen.</p> <p>Press the right soft button (READ) to change to the Data Reading screen, to read and show the data.</p> <p>On the Data Reading screen, you can press the right soft button to feed the media and attempt to read the tag currently set in the printer.</p>	

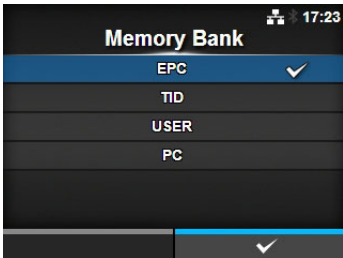
Memory Bank UHF HF	
<p><i>Interface > RFID > View > Memory Bank</i></p> <p>Set the memory area of the RFID tag to read. The readable memory areas are as follows:</p> <p>If the installed module is UHF</p> <ul style="list-style-type: none"> • EPC: EPC area • TID: TID area • USER: USER area • PC: PC/AFI area <p>If the installed module is HF</p> <ul style="list-style-type: none"> • USER: USER area • UID: UID area 	

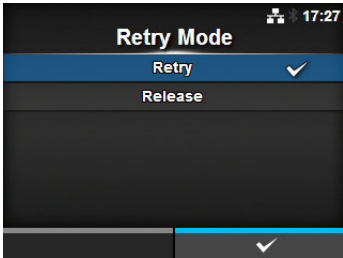
Retry Mode UHF HF	
<p><i>Interface > RFID > Retry Mode</i></p> <p>Set whether to retry encoding of failed data when an RFID tag error occurs.</p> <p>The options are as follows:</p> <ul style="list-style-type: none"> • Retry: The printer will continue to attempt encoding the same data. However, if you have set the Retries to 0, the RFID error screen shows and printing continues. • Release: Deletes the current print job, allowing the printer to move on to the next print job. If the RFID error occurs continuously and reaches the maximum number of Retries, printing stops. 	

Retries UHF HF	
<p><i>Interface > RFID > Retries</i></p> <p>Set the number of failed encoding attempts before error warning/print pause. The setting range is from 0 to 9. If you set to 0, the RFID error screen shows and printing continues.</p>	

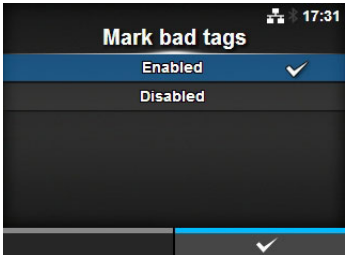
Mark bad tags UHF HF	
<p><i>Interface > RFID > Mark bad tags</i></p> <p>Set the error print for the RFID tag error.</p> <ul style="list-style-type: none">• Enabled: Enable the RFID error print function.• Disabled: Disable the RFID error print function. <p>For details on the RFID error print, refer to Section 7.5.1 Printing RFID Tag Errors.</p>	

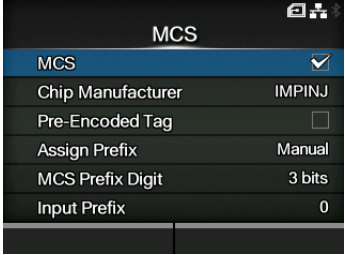
MCS			UHF
<p><i>Interface > RFID > MCS</i></p> <p>Set the Multi vendor Chip-based Serialization. Shows only if the module is UHF. The setting items are as follows:</p>			
1	MCS	Enable or disable the Multi vendor Chip-based Serialization.	
2	Chip Manufacturer	Manually set MCS manufacturer prefix. *Shows only if you have selected Enabled in the MCS menu.	
3	Pre-Encoded Tag	Enable or disable for tags with pre-encoded EPC serial numbers. *Shows only if you have selected Enabled in the MCS menu.	
4	Assign Prefix	Set how to assign the three digit prefix data. *Shows only if you have selected Enabled in the MCS menu.	
5	MCS Prefix Digit	Set the length of manually assigned MCS manufacturer prefix. *Shows only if you have selected Manual in the Assign Prefix menu.	
6	Input Prefix	Set the contents of MCS prefix. *Shows only if you have selected Manual in the Assign Prefix menu and if you have selected anything other than None in the MCS Prefix Digit menu.	

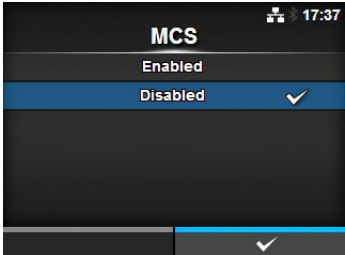
MCS			UHF
<p><i>Interface > RFID > MCS > MCS</i></p> <p>Enable or disable the Multi vendor Chip-based Serialization. The options are as follows:</p> <ul style="list-style-type: none"> • Enabled: Enable the Multi vendor Chip-based Serialization. • Disabled: Disable the Multi vendor Chip-based Serialization. 			
<p>Note Multi vendor Chip-based Serialization: use TID as base for SGTIN serial number.</p>			

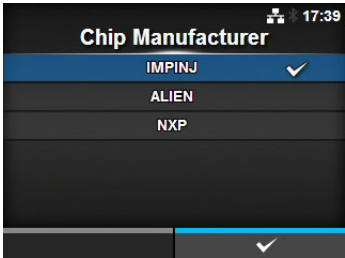
Chip Manufacturer	UHF
<p><i>Interface > RFID > MCS > Chip Manufacturer</i></p> <p>Manually set MCS manufacturer prefix. Shows only if you have selected Enabled in the MCS menu. The options are as follows:</p> <ul style="list-style-type: none"> • IMPINJ • ALIEN • NXP 	

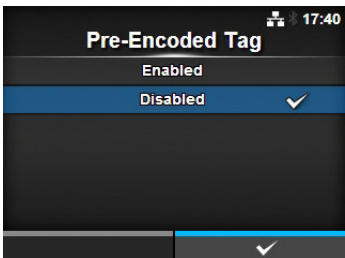
Pre-Encoded Tag	UHF
<p><i>Interface > RFID > MCS > Pre-Encoded Tag</i></p> <p>Enable or disable for tags with pre-encoded EPC serial numbers. EPC GTIN data is still required. Shows only if you have selected Enabled in the MCS menu. The options are as follows:</p> <ul style="list-style-type: none"> • Enabled: Enable the pre-encoded tag. • Disabled: Disable the pre-encoded tag. 	

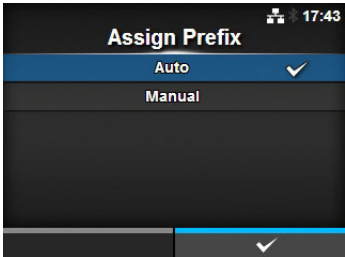
Assign Prefix	UHF
<p><i>Interface > RFID > MCS > Assign Prefix</i></p> <p>Set how to assign the three digit prefix data. Shows only if you have selected Enabled in the MCS menu. The options are as follows:</p> <ul style="list-style-type: none"> • Auto: Set to the manufacturer prefix selected in Chip Manufacturer. • Manual: Set to the prefix determined by the MCS Prefix Digit and Input Prefix. <hr/> <p>Note Does not show if Chip Manufacturer is NXP and Pre-Encoded Tag is enabled.</p>	

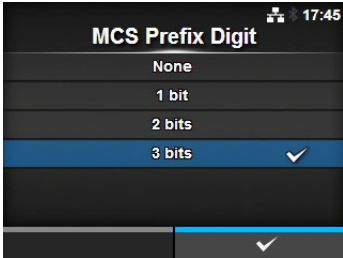
MCS Prefix Digit		UHF
<p><i>Interface > RFID > MCS > MCS Prefix Digit</i></p> <p>Set the length of manually assigned MCS manufacturer prefix. This screen shows only if you have selected Manual in the Assign Prefix menu.</p> <p>The options are as follows:</p> <ul style="list-style-type: none"> • None: Set the number of digits of the prefix data to 0. Fill in 0 for all three 3 digits of the prefix data. • 1 bit: Set the number of digits of the prefix data to 1 digit. Fill in 0 for the lower 2 bits of the prefix data. • 2 bits: Set the number of digits of the prefix data to 2 digits. Fill in 0 for the lower 1 bit of the prefix data. • 3 bits: Set the number of digits of the prefix data to 3 digits. <hr/> <p>Note Does not show if Chip Manufacturer is NXP and Pre-Encoded Tag is enabled.</p>	 <p>The screenshot shows a mobile application interface titled 'MCS Prefix Digit' with a status bar at the top showing '17:45'. The menu options are 'None', '1 bit', '2 bits', and '3 bits'. The '3 bits' option is highlighted in blue and has a checkmark to its right. At the bottom of the screen, there is a navigation bar with a checkmark icon.</p>	

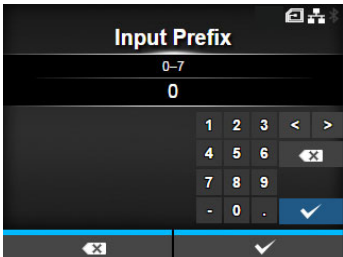
Input Prefix		UHF
<p><i>Interface > RFID > MCS > Input Prefix</i></p> <p>Set the contents of MCS prefix. This screen shows only if you have selected Manual in the Assign Prefix menu and if you have selected anything other than None in the MCS Prefix Digit menu.</p> <p>The setting range is from 0 to 7.</p> <hr/> <p>Note</p> <ul style="list-style-type: none"> • Does not show if Chip Manufacturer is NXP and Pre-Encoded Tag is enabled. • The setting range varies depending on the setting value in MCS Prefix Digit. 	 <p>The screenshot shows a mobile application interface titled 'Input Prefix' with a status bar at the top showing '0-7'. The main display shows the number '0'. Below the display is a numeric keypad with digits 1-9, a decimal point, and a zero key. There are also left and right arrow keys and a clear key. At the bottom of the screen, there is a navigation bar with a checkmark icon.</p>	

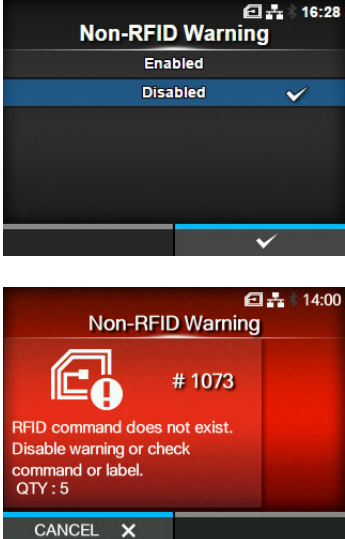
Non-RFID Warning	UHF HF
<p><i>Interface > RFID > Non-RFID Warning</i></p> <p>Set the warning for non-RFID error. The options are as follows:</p> <ul style="list-style-type: none"> • Enabled: Show the non-RFID warning upon error. • Disabled: Ignore the non-RFID error. <p>With Non-RFID warning enabled and RFID tag loaded, if the items received do not contain an RFID issue command, a warning error shows before printing so that the RFID tag will not be wasted. Press the left soft button (CANCEL) to clear the warning message.</p>	

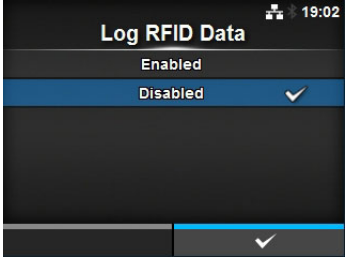
Log RFID Data	UHF HF
<p><i>Interface > RFID > Log RFID Data</i></p> <p>Set the log function to record the encoded tag information. The log data can record up to 100 tags of information. The options are as follows:</p> <ul style="list-style-type: none"> • Enabled: Enable the log function to record the RFID data. • Disabled: Disable the log function to record the RFID data. <hr/> <p>Note UID data is recorded if the module is HF.</p>	

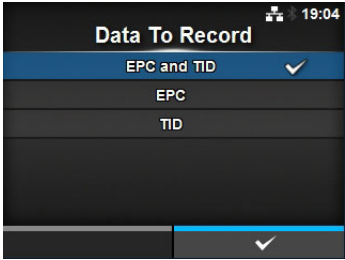
Data To Record	UHF
<p><i>Interface > RFID > Data To Record</i></p> <p>Set the data to record the log when Log RFID Data is enabled. The options are as follows:</p> <ul style="list-style-type: none"> • EPC and TID: Store the EPC and TID data. • EPC: Store the EPC data. • TID: Store the TID data. <p>* Shows only if the module is UHF.</p>	

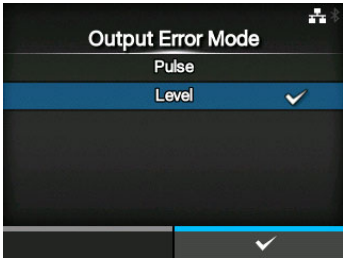
Output Error Mode		UHF HF
<i>Interface > RFID > Output Error Mode</i>		
<p>Set the signal type for RFID errors. The options are as follows:</p> <ul style="list-style-type: none"> • Pulse: Outputs a pulse as the output signal when an RFID error occurs. • Level: Outputs a level as the output signal when an RFID error occurs. 		

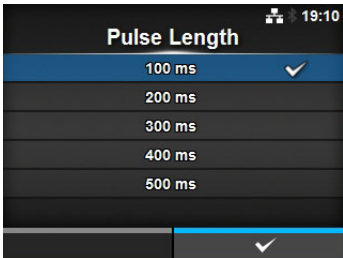
Pulse Length		UHF HF
<i>Interface > RFID > Pulse Length</i>		
<p>Set the length of an RFID error pulse. Shows only if you have selected Pulse in the Output Error Mode menu. The options are as follows:</p> <ul style="list-style-type: none"> • 100 ms • 200 ms • 300 ms • 400 ms • 500 ms 		

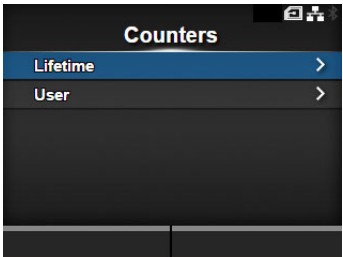
Counters			UHF HF
<i>Interface > RFID > Counters</i>			
Shows the RFID counter. The display items are as follows:			
1	Lifetime	Shows the number of encoding successes, failures, and total attempts.	
2	User	Shows the number of encoding successes, failures, and total attempts after the RFID counter is cleared.	

Lifetime UHF HF		
<p><i>Interface > RFID > Counters > Lifetime</i></p> <p>Shows the number of encoding successes, failures, and total attempts. The display items are as follows:</p>		
1	Count Success	Shows the total number of successful times you have written to an RFID tag.
2	Count Failure	Shows the total number of RFID write errors.
3	Count Total	Shows the total number of times you have written to an RFID tag. This is the total number including Count Success and Count Failure.

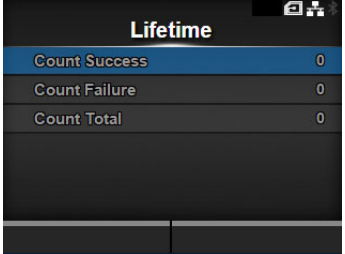

User UHF HF		
<p><i>Interface > RFID > Counters > User</i></p> <p>Shows the number of encoding successes, failures, and total attempts after the RFID counter is cleared. The display items are as follows:</p>		
1	Count Success	Shows the total number of successful times you have written to an RFID tag after the RFID counter is cleared.
2	Count Failure	Shows the total number of RFID write errors after the RFID counter is cleared.
3	Count Total	Shows the total number of times you have written to an RFID tag after the RFID counter is cleared. This is the total number including Count Success and Count Failure.



Note
You can reset the counter using the right soft button (**CLEAR**) when the counter is 1 or higher.

4.4.4 Applications Menu

In the **Applications** menu, there are setting items as follows:

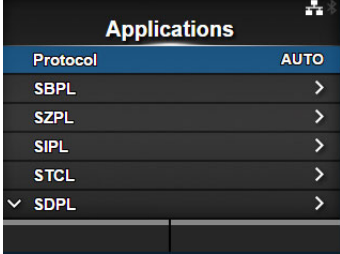
Applications			
1	Protocol	Set the printer language.	
2	SBPL	Set the SBPL printer command.	
3	SZPL	Set the SZPL printer command.	
4	SIPL	Set the SIPL printer command.	
5	STCL	Set the STCL printer command.	
6	SDPL	Set the SDPL printer command.	
7	SEPL	Set the SEPL printer command.	
8	AEP	Set the functions for AEP (Application Enabled Printing).	

Protocol

Applications > Protocol

Set the printer language.
The options are as follows:

- **AUTO**: Automatically analyze the received print data and set the printer language. In Auto mode, the printer can change the language after startup by receiving another language.
- **SBPL**: Set when you use the SBPL printer language or XML.
- **SZPL**: Set when you use the SZPL printer language.
- **SIPL**: Set when you use the SIPL printer language.
- **SDPL**: Set when you use the SDPL printer language.
- **STCL**: Set when you use the STCL printer language.
- **SEPL**: Set when you use the SEPL printer language.

Protocol

AUTO ✓

SBPL

SZPL

SIPL

SDPL

STCL

Note (When AUTO is selected in the Protocol menu)

- When **AUTO** is selected, the message prompting to restart the printer will appear on the online/offline screen. In such a case, reboot the printer to make the setting effective.
- Once the printer language is fixed, the name of the printer language will appear on the online/offline screen. The area to show the name of the printer language will remain blank until the printer language is finalized.



The area remains blank until the printer language is finalized.

➔

For example,
send print
data in SBPL.



- Printer language is finalized with the received print data.
- Non-Standard Code is not supported. When **Standard Code** under **SBPL** in the **Applications** menu is disabled, the **Protocol** setting will be changed to **SBPL**.

SBPL

Applications > SBPL

SBPL (Sato Barcode Printer Language) is the common command that controls SATO barcode label printers.
To use SBPL as a printer command, set the following items:

1	Show Error	Enable or disable the command error indication.
2	Standard Code	Set the protocol code.
3	Orientation	Set the layout for printing.
4	Font Settings	Set the font.
5	Compatible	Set the compatible code.

SBPL

Show Error

Standard Code

Orientation Portrait

Font Settings >

Compatible >

Show Error

Applications > SBPL > Show Error

Enable or disable the command error indication when incorrect command or parameter is detected in the print data.

The options are as follows:

- **Enabled:** Enable the command error indication. The command error is shown and the print operation is paused when incorrect command or parameter is detected in the print data.
- **Disabled:** Disable the command error indication.

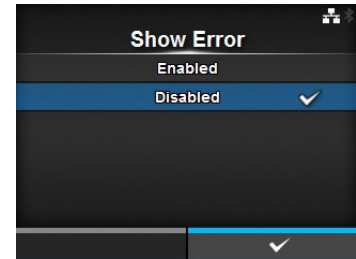

Standard Code

Applications > SBPL > Standard Code

Set the protocol code.

The options are as follows:

- **Enabled:** Use a standard code.
- **Disabled:** Use a non-standard code.

Note

- The message prompting to restart the printer will appear on the online/offline screen if you have made any changes. In such a case, reboot the printer to make the setting effective.
- When **AUTO** is selected in the **Protocol** menu while **Disabled** is selected, the setting will be changed to **Enabled**.

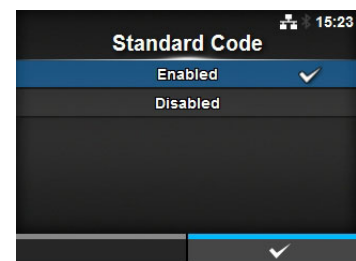

Orientation

Applications > SBPL > Orientation

Select the layout for printing the label.

- **Portrait:** Use a portrait layout. (No rotation)
- **Landscape:** Use a landscape layout. (90-degree rotation)
- **Inv. Portrait:** Use an inverse portrait layout. (180-degree rotation)
- **Inv. Landscape:** Use an inverse landscape layout. (270-degree rotation)

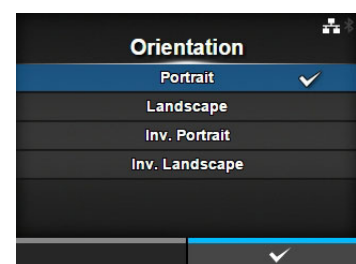

Font Settings		
<p><i>Applications > SBPL > Font Settings</i></p> <p>Set the font. The setting items are as follows:</p>		
1	Zero Slash	Set the type for printing zero.
2	Kanji	Set the kanji code to be used.
3	Proportional	Set the character pitch for printing.
4	Code Page	Set the code page to be used.
5	€	Set the European currency symbol to a hex code.

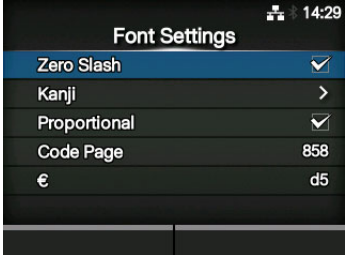

Zero Slash	
<p><i>Applications > SBPL > Font Settings > Zero Slash</i></p> <p>Set whether to print the number zero (0) with or without a slash (/). This setting is applied to the following bitmap fonts: U, S, M, WB, WL, XU, XS, XM, XL, X20, X21, X22, X23, X24 The options are as follows:</p> <ul style="list-style-type: none"> • Enabled: Print zero with a slash. • Disabled: Print zero without a slash. 	

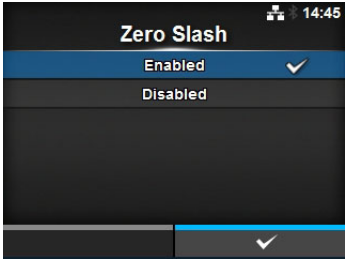

Kanji		
<p><i>Applications > SBPL > Font Settings > Kanji</i></p> <p>Set the kanji code to be used. The setting items are as follows:</p>		
1	Kanji Set	Set the kanji code to be used.
2	Character Code	Set the character code to be used.
3	Kanji Style	Set the font to be used.

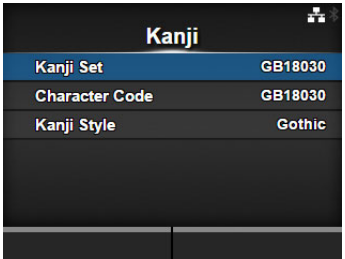

Kanji Set

Applications > SBPL > Font Settings > Kanji > Kanji Set

Set the kanji code to be used.
The options are as follows:

- **JP-COMPATIBLE**
- **JP-JISX0208**
- **JP-JISX0213**
- **GB18030**
- **BIG5**
- **KSC5601**

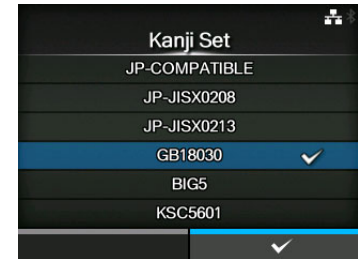

Character Code

Applications > SBPL > Font Settings > Kanji > Character Code

Set the character code to be used.
The options vary depending on the kanji code set in the **Kanji Set**:

When set to **JP-COMPATIBLE** or **JP-JISX0208**

- **JIS**
- **SJIS**
- **UTF-16**

When set to **JP-JISX0213**

- **SJIS**
- **UTF-16**

When set to **GB18030**

- **GB18030**

When set to **BIG5**

- **BIG5**

When set to **KSC5601**

- **KSC5601**

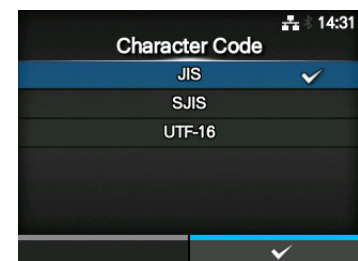

Kanji Style

Applications > SBPL > Font Settings > Kanji > Kanji Style

Set the font to be used.
The options are as follows:

- **Mincho**
- **Gothic**

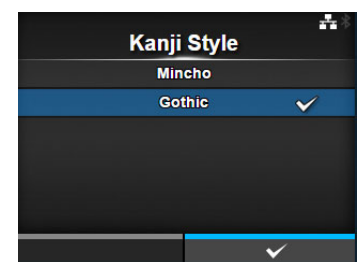

Proportional

Applications > SBPL > Font Settings > Proportional

Set whether to print each character using a proportional pitch or fixed pitch.
The options are as follows:

- **Enabled:** Print each character with a proportional pitch.
- **Disabled:** Print all characters with a fixed pitch.

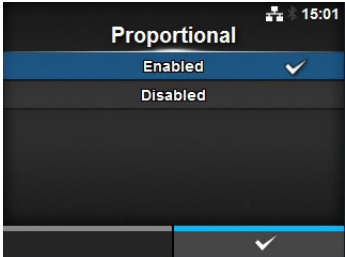

Code Page

Applications > SBPL > Font Settings > Code Page

Select the code page to be used from the list.

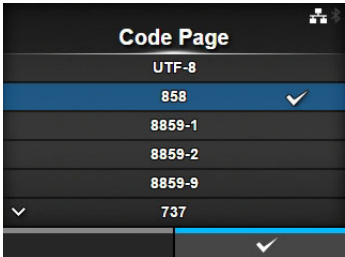

€

Applications > SBPL > Font Settings > €

Set the European currency symbol to a hex code.
The setting range is from 00 to ff (hexadecimal).

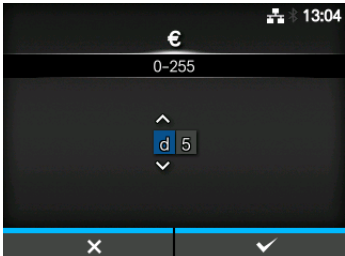

Compatible		
<p><i>Applications > SBPL > Compatible</i></p> <p>Set the compatible code for SBPL. The setting items are as follows:</p>		
1	M-8400 Compatibility	Enable or disable the M-8400 printer compatibility function.
2	CODE128(C) Zero Fill	Set whether to allow odd digits and print the barcode with zero-filling when start code C is used in CODE128. *If M-8400 Compatibility is set to Enabled , this setting is automatically enabled and does not show.
3	Kanji Command	Set the printer behavior when the received data includes the Kanji command ESC+K5, ESC+K6 or ESC+K7.
4	Call Font/Logo	Set how to process the character code specified in Recall font & logo command (ESC+RF).
5	ENQ Reply Delay	Set the period to delay status reply to status request ENQ.
6	ENQ Reply Cycle	Set the interval for the status reply cycle to status request ENQ.

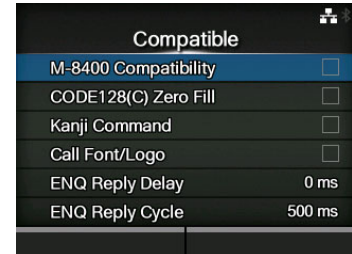

M-8400 Compatibility	
<p><i>Applications > SBPL > Compatible > M-8400 Compatibility</i></p> <p>Enable or disable the M-8400 printer compatibility function. The options are as follows:</p> <ul style="list-style-type: none"> • Enabled: Enable the M-8400 printer compatibility function. • Disabled: Disable the M-8400 printer compatibility function. 	
<p>Note</p> <ul style="list-style-type: none"> • Contact your SATO sales representative for more information about the M-8400 printer compatibility function. • If M-8400 Compatibility is set to Enabled, CODE128(C) Zero Fill is automatically enabled and the setting item does not show. 	

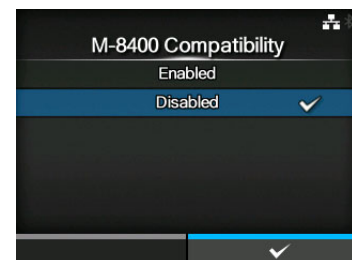

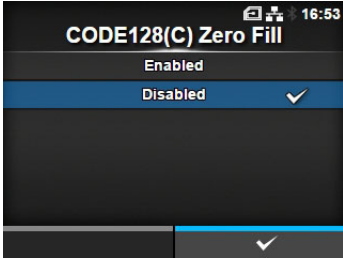
CODE128(C) Zero Fill	
<p><i>Applications > SBPL > Compatible > CODE128(C) Zero Fill</i></p> <p>Set whether to allow odd digits and print the barcode with zero-filling in case start code C is used in CODE128.</p> <p>If M-8400 Compatibility is set to Enabled, this setting is automatically enabled and does not show.</p> <p>The options are as follows:</p> <ul style="list-style-type: none"> • Enabled: Allow odd digits and print the barcode with zero-filling. • Disabled: Do not allow odd digits. A command error occurs and the barcode will not be printed. 	

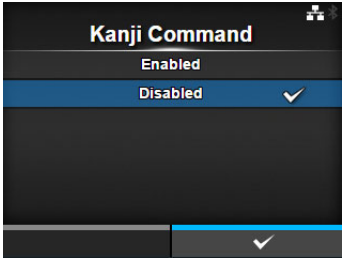
Kanji Command	
<p><i>Applications > SBPL > Compatible > Kanji Command</i></p> <p>Set the printer behavior when the received data includes the Kanji command ESC+K5, ESC+K6 or ESC+K7.</p> <p>The options are as follows:</p> <ul style="list-style-type: none"> • Enabled: Change the Kanji commands ESC+K5, ESC+K6 and ESC+K7 in the received data to the proper commands and print. ESC+K5: 16x16 dots Kanji in horizontal line with 1-byte character ESC+K6: 24x24 dots Kanji in horizontal line with 1-byte character ESC+K7: 22x22 dots Kanji in horizontal line • Disabled: Do not change the Kanji commands ESC+K5, ESC+K6 and ESC+K7 in the received data. The printer behavior when it receives these commands is as follows: ESC+K5: Print with 40x40 dots Kanji in horizontal line. ESC+K6: A command error occurs and the data will not be printed. ESC+K7: A command error occurs and the data will not be printed. 	

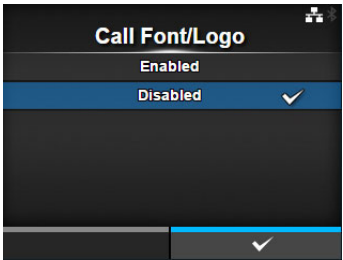
Call Font/Logo	
<p><i>Applications > SBPL > Compatible > Call Font/Logo</i></p> <p>Set how to process the character code specified in Recall font & logo command (ESC+RF).</p> <p>The options are as follows:</p> <ul style="list-style-type: none"> • Enabled: Character codes are processed in little-endian format. • Disabled: Character codes are processed in big-endian format. 	

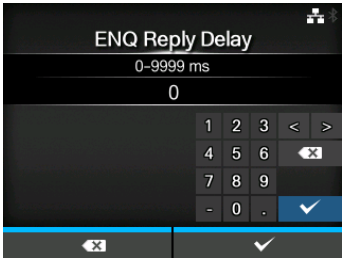
ENQ Reply Delay	
<p><i>Applications > SBPL > Compatible > ENQ Reply Delay</i></p> <p>Set the period to delay status reply to status request ENQ. The target interfaces are LAN and Wireless LAN. The target statuses are Status3, Status4 ENQ reply, and Status5. The setting range is from 0 to 9999 ms.</p>	

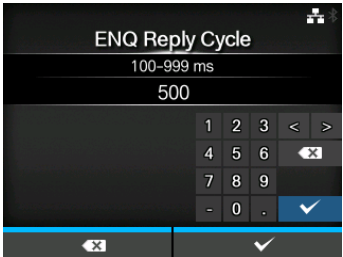
ENQ Reply Cycle	
<p><i>Applications > SBPL > Compatible > ENQ Reply Cycle</i></p> <p>Set the interval for the status reply cycle to status request ENQ. The target interfaces are LAN and Wireless LAN. The target status is Status4 reply cycle. The setting range is from 100 to 999 ms.</p>	

SZPL		
<p><i>Applications > SZPL</i></p> <p>To use SZPL as a printer command, set the following items:</p>		
1	Label	Set the print position.
2	Caret	Set the caret (^) code.
3	Delimiter	Set the delimiter (,) code.
4	Tilde	Set the tilde (~) code.
5	Clock Format	Set the date format.

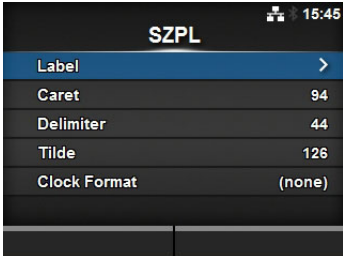

Label		
<p><i>Applications > SZPL > Label</i></p> <p>Set the print position. The setting items are as follows:</p>		
1	Shift	Set the shift offset position of the label.
2	Top	Set the top offset position of the label.

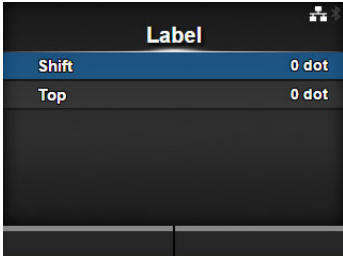

Shift	
<p><i>Applications > SZPL > Label > Shift</i></p> <p>Set the shift offset position of the label. The setting range varies depending on the print resolution of the printer. The setting range is as follows:</p> <p><CL4NX></p> <ul style="list-style-type: none">• 203 dpi: -832 to 0 to 832 dots• 305 dpi: -1248 to 0 to 1248 dots• 609 dpi: -2496 to 0 to 2496 dots <p><CL6NX></p> <ul style="list-style-type: none">• 203 dpi: -832 to 0 to 832 dots• 305 dpi: -1248 to 0 to 1248 dots	

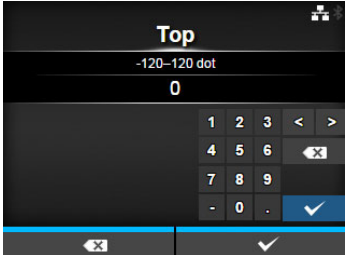
Top	
<p><i>Applications > SZPL > Label > Top</i></p> <p>Set the top offset position of the label. The setting range is from -120 to 0 to 120 dots.</p>	

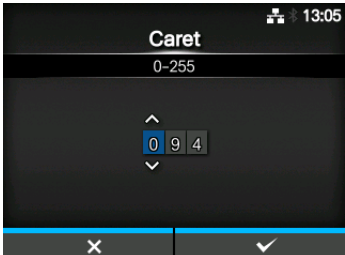
Caret	
<p><i>Applications > SZPL > Caret</i></p> <p>Set the caret (^) code. The setting range is from 0 to 255.</p>	

Delimiter

Applications > SZPL > Delimiter

Set the delimiter (,) code.
The setting range is from 0 to 255.

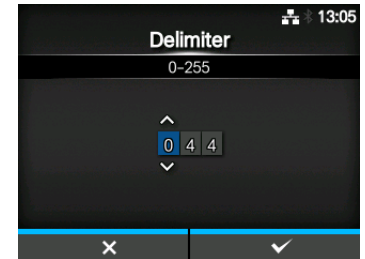

Tilde

Applications > SZPL > Tilde

Set the tilde (~) code.
The setting range is from 0 to 255.

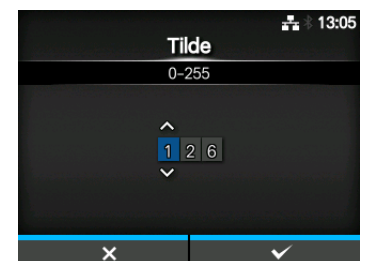

Clock Format

Applications > SZPL > Clock Format

Set the date format.
The options are as follows:

- **(none)**
- **MM/DD/YY (24-hour clock)**
- **MM/DD/YY (12-hour clock)**
- **DD/MM/YY (24-hour clock)**
- **DD/MM/YY (12-hour clock)**

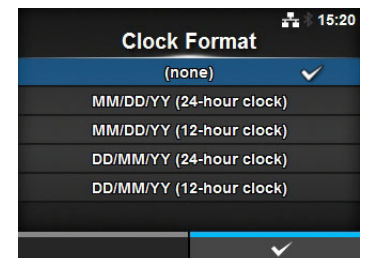

SIPL

Applications > SIPL

To use SIPL as a printer command, set the following items:

1	Font Settings	Set the font.
2	Format Save	Set whether to save the user format data registered at printing in the printer.

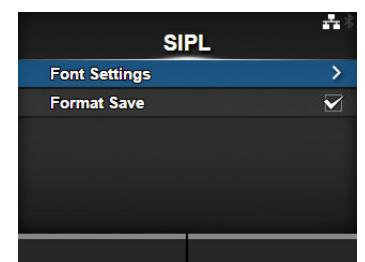

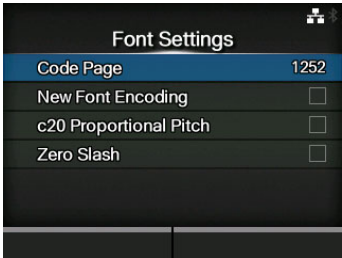
Font Settings			
<p><i>Applications > SIPL > Font Settings</i></p> <p>Set the font. The setting items are as follows:</p>			
1	Code Page		Set the code page to be used.
2	New Font Encoding		Enable or disable new font encoding.
3	c20 Proportional Pitch		Set the character pitch for printing.
4	Zero Slash		Set the type for printing zero.

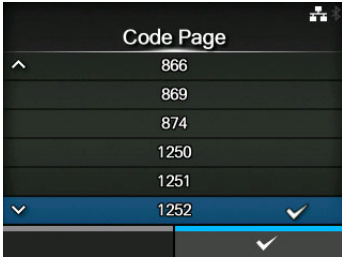
Code Page	
<p><i>Applications > SIPL > Font Settings > Code Page</i></p> <p>Select the code page to be used from the list.</p>	

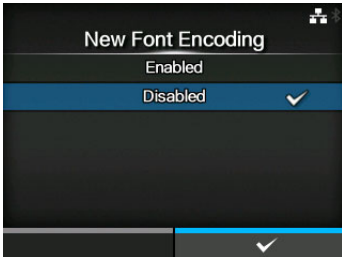
New Font Encoding	
<p><i>Applications > SIPL > Font Settings > New Font Encoding</i></p> <p>Enable or disable new font encoding. The options are as follows:</p> <ul style="list-style-type: none"> • Enabled: Enable new font encoding. • Disabled: Disable new font encoding. <hr/> <p>Note Contact your SATO sales representative for more information about the new font.</p>	

c20 Proportional Pitch

Applications > SIPL > Font Settings > c20 Proportional Pitch

Set whether to print each character using a proportional pitch or fixed pitch.

The options are as follows:

- **Enabled:** Print each character with a proportional pitch.
- **Disabled:** Print all characters with a fixed pitch.

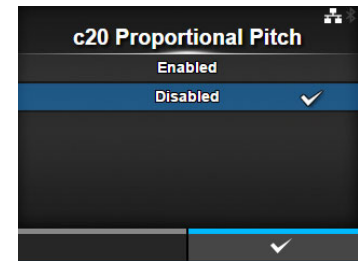

Zero Slash

Applications > SIPL > Font Settings > Zero Slash

Set whether to print the number zero (0) with or without a slash (/).

The options are as follows:

- **Enabled:** Print zero with a slash.
- **Disabled:** Print zero without a slash.

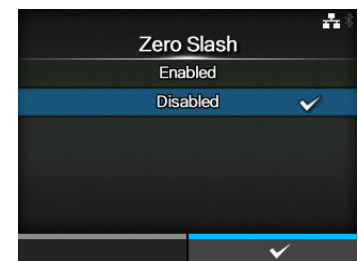

Format Save

Applications > SIPL > Format Save

Set whether to save the user format data registered at printing in the printer.

The options are as follows:

- **Enabled:** Save the user format data registered at printing in the printer.
- **Disabled:** Do not save the user format data registered at printing in the printer. The user format data remains in the printer memory until the printer is powered off. You need to register a user format again after reboot.

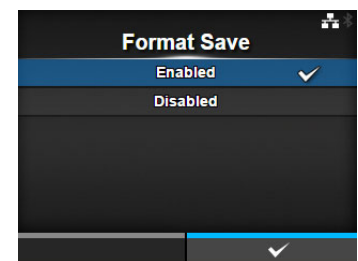

STCL

Applications > STCL

To use STCL as a printer command, set the following items:

1	Command Head	Set the command head.
2	Font Settings	Set the font.
3	Rotation	Set the page orientation for label printing.
4	Ignore Paper Size Command	Set whether to ignore a paper size command in the print data.

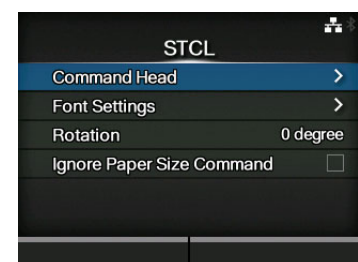

Command Head

Applications > STCL > Command Head

Set the command head.
The setting items are as follows:

1	Control Code	Set the control code.
2	1st Byte Code	Set the first byte code.
3	2nd Byte Code	Set the second byte code.
4	3rd Byte Code	Set the third byte code.

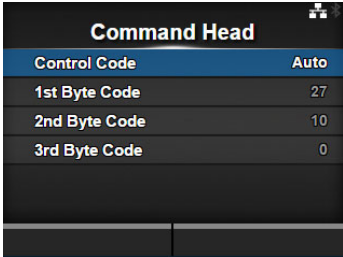

Control Code

Applications > STCL > Command Head > Control Code

Set the control code.
The options are as follows:

- **Auto**: Perform the protocol detection automatically.
- **ESC|LF|NUL**
- **7B|7C|7D**
- **Custom**: Change the first to third byte codes.

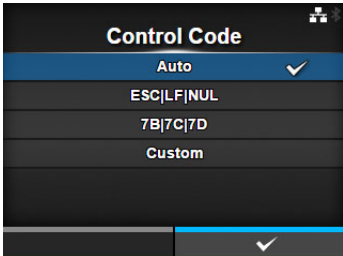

1st Byte Code

Applications > STCL > Command Head > 1st Byte Code

Set the first byte code.
You can change the code only if you have selected **Custom** in the **Control Code** menu.
The setting range is from 0 to 255.

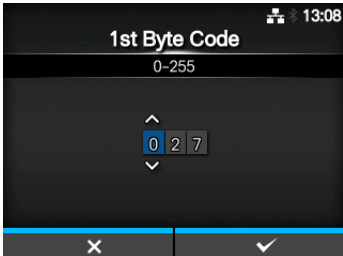

2nd Byte Code

Applications > STCL > Command Head > 2nd Byte Code

Set the second byte code.
You can change the code only if you have selected **Custom** in the **Control Code** menu.
The setting range is from 0 to 255.

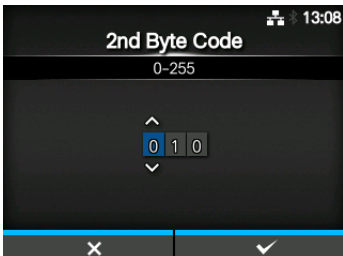

3rd Byte Code

Applications > STCL > Command Head > 3rd Byte Code

Set the third byte code.
You can change the code only if you have selected **Custom** in the **Control Code** menu.
The setting range is from 0 to 255.

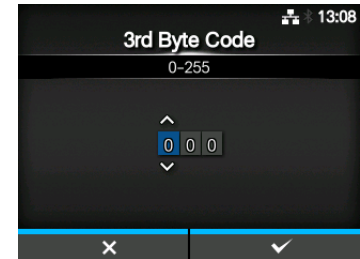

Font Settings

Applications > STCL > Font Settings

Set the font.
The setting items are as follows:

1	Zero Slash	Set the type for printing zero.
2	€	Set the European currency symbol to a hex code.
3	Code Page	Set the code page to be used.
4	Half-width Symbol	Set whether to print symbols with half-width characters.

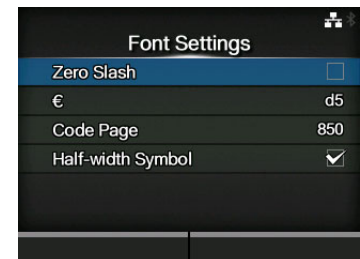

Zero Slash

Applications > STCL > Font Settings > Zero Slash

Set whether to print the number zero (0) with or without a slash (/).
The options are as follows:

- **Enabled**: Print zero with a slash.
- **Disabled**: Print zero without a slash.

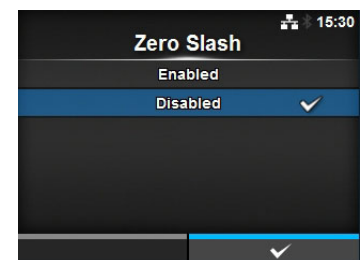

€

Applications > STCL > Font Settings > €

Set the European currency symbol to a hex code.
The setting range is from 00 to ff (hexadecimal).

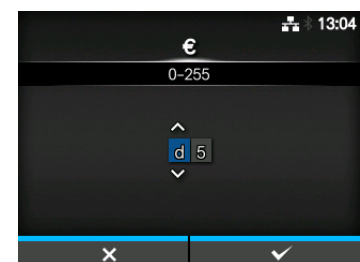

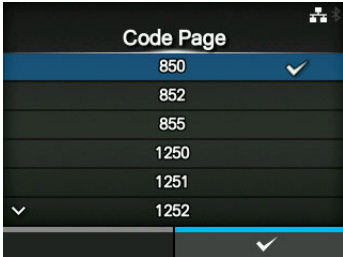
Code Page	
<p><i>Applications > STCL > Font Settings > Code Page</i></p> <p>Select the code page to be used from the list.</p>	

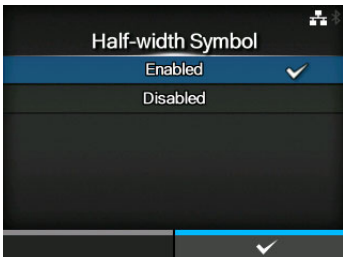
Half-width Symbol	
<p><i>Applications > STCL > Font Settings > Half-width Symbol</i></p> <p>Set whether to print symbols with half-width characters. The options are as follows:</p> <ul style="list-style-type: none">• Enabled: Print symbols with half-width characters.• Disabled: Do not print symbols with half-width characters.	

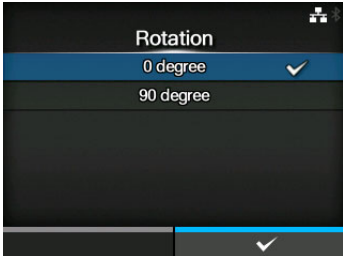
Rotation	
<p><i>Applications > STCL > Rotation</i></p> <p>Set the page orientation for label printing. The options are as follows:</p> <ul style="list-style-type: none">• 0 degree: Labels are printed in portrait orientation.• 90 degree: Labels are printed in landscape orientation.	

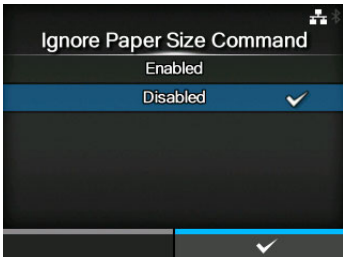
Ignore Paper Size Command	
<p><i>Applications > STCL > Ignore Paper Size Command</i></p> <p>Set whether to ignore a paper size command in the print data. The options are as follows:</p> <ul style="list-style-type: none">• Enabled: Ignore a paper size command in the print data.• Disabled: Do not ignore a paper size command in the print data.	

SDPL		
<i>Applications > SDPL</i>		
To use SDPL as a printer command, set the following items:		
1	Control Code	Set the control code.
2	Label Rotation	Set the page orientation for label printing.
3	SOP Emulation	Set the SOP emulation.
4	Compatible Mode	Set the compatible mode for SDPL.
5	Right-to-Left print	Set the Right-to-Left printing function.
6	Prioritize	Select the settings to be prioritized for the SDPL command.
7	Format Attribute	Set the format attribute.
8	Pause Mode	Enable or disable the pause mode.
9	1 Byte Codepage	Select the code page to be used for 1-byte characters.
10	SDPL Measure Unit	Set the measurement unit.
11	Scalable Font Style	Set the style of the scalable fonts.
<p>Note Format Attribute, Pause Mode, 1 Byte Codepage, SDPL Measure Unit and Scalable Font Style are available only if Settings is selected for the corresponding setting item under the Prioritize menu.</p>		

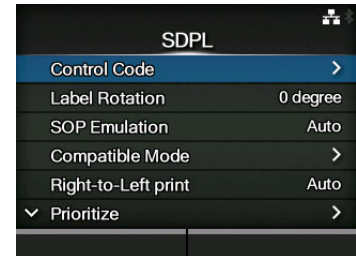

Control Code		
<i>Applications > SDPL > Control Code</i>		
Set the control code. The setting items are as follows:		
1	Code Type	Set the type of the control code.
2	SOH	Set the SOH code.
3	STX	Set the STX code.
4	CR	Set the CR code.
5	CNTBY	Set the CNTBY code.

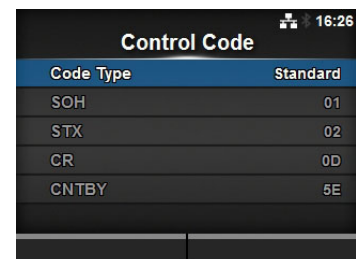

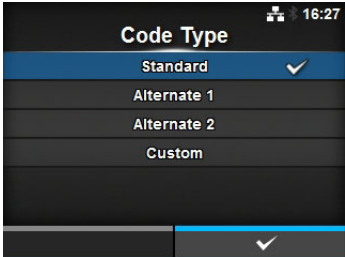
Code Type	
<p><i>Applications > SDPL > Control Code > Code Type</i></p> <p>Set the control code type. The options are as follows:</p> <ul style="list-style-type: none"> • Standard • Alternate 1 • Alternate 2 • Custom 	

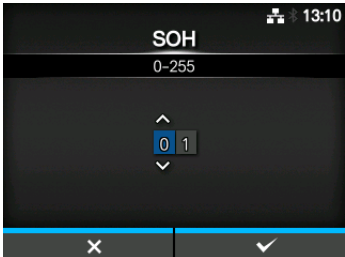
SOH	
<p><i>Applications > SDPL > Control Code > SOH</i></p> <p>Set the SOH code. You can change the code only if you have selected Custom in the Code Type menu. The setting range is from 00 to ff (hexadecimal).</p>	

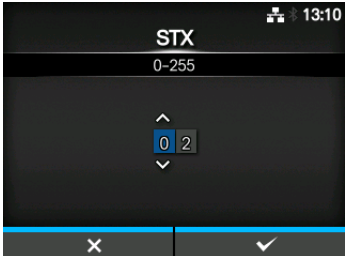
STX	
<p><i>Applications > SDPL > Control Code > STX</i></p> <p>Set the STX code. You can change the code only if you have selected Custom in the Code Type menu. The setting range is from 00 to ff (hexadecimal).</p>	

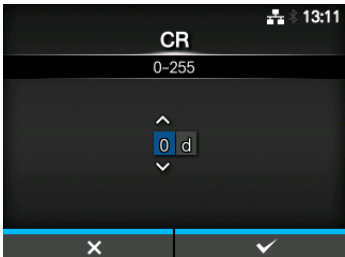
CR	
<p><i>Applications > SDPL > Control Code > CR</i></p> <p>Set the CR code. You can change the code only if you have selected Custom in the Code Type menu. The setting range is from 00 to ff (hexadecimal).</p>	

CNTBY

Applications > SDPL > Control Code > CNTBY

Set the CNTBY code.

You can change the code only if you have selected **Custom** in the **Code Type** menu.

The setting range is from 00 to ff (hexadecimal).

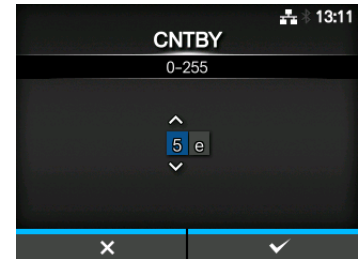

Label Rotation

Applications > SDPL > Label Rotation

Set the page orientation for label printing.

The label size set in the printer is used as a reference of rotation.

The options are as follows:

- **0 degree:** Labels are printed in portrait orientation.
- **90 degree:** Labels are printed in landscape orientation.
- **180 degree:** Labels are printed in inverse-portrait orientation.
- **270 degree:** Labels are printed in inverse-landscape orientation.

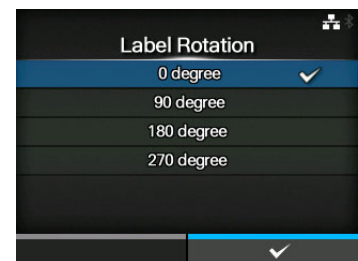

SOP Emulation

Applications > SDPL > SOP Emulation

Set the SOP emulation.

The options are as follows:

- **Disabled**
- **Prodigy Plus - 110**
- **Allegro - 220**
- **Prodigy - 250**
- **Auto**

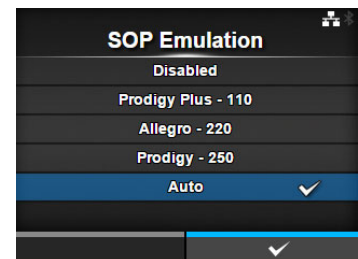

Compatible Mode

Applications > SDPL > Compatible Mode

Set the compatible mode for SDPL.

The setting items are as follows:

1	TTF	Enable or disable TrueType font compatible mode.
2	Graphics	Set whether to allow the registration of graphic data even if a line feed code is omitted.

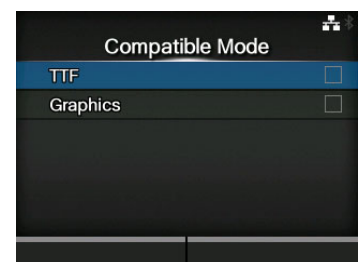

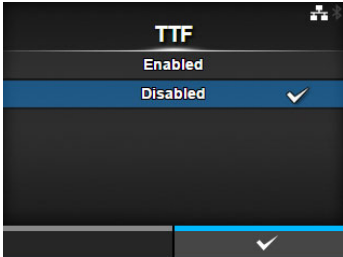
TTF	
<p><i>Applications > SDPL > Compatible Mode > TTF</i></p> <p>Enable or disable TrueType font compatible mode. The options are as follows:</p> <ul style="list-style-type: none">• Enabled: Enable TrueType font compatible mode. The bold TrueType fonts are printed in smaller pitch.• Disabled: Disable TrueType font compatible mode.	

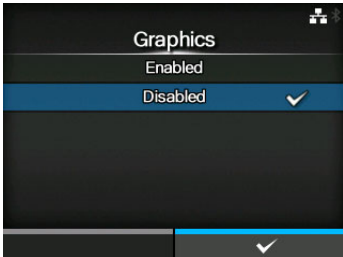
Graphics	
<p><i>Applications > SDPL > Compatible Mode > Graphics</i></p> <p>Set whether to allow the registration of graphic data even if a line feed code is omitted. The options are as follows:</p> <ul style="list-style-type: none">• Enabled: Allow the registration of graphic data even when a line feed code is omitted.• Disabled: Do not allow the registration of graphic data when a line feed code is omitted.	

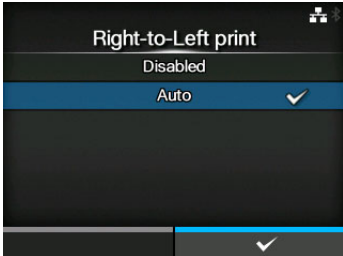
Right-to-Left print	
<p><i>Applications > SDPL > Right-to-Left print</i></p> <p>Set the Right-to-Left printing function. The options are as follows:</p> <ul style="list-style-type: none">• Disabled: All texts are printed from left to right.• Auto: When an Arabic font is detected, the Arabic text is printed from right to left.	

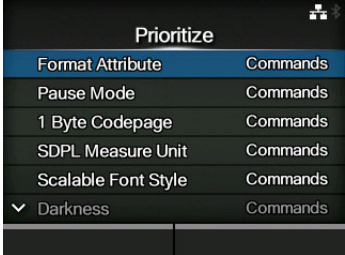
Prioritize			
<p><i>Applications > SDPL > Prioritize</i></p> <p>Select the settings to be prioritized for each setting item of the SDPL command. You can set whether to prioritize settings through the printer or through commands.</p> <p>When you select Settings for an item, the setting specified in the SDPL menu of the printer will be used.</p> <p>The setting items are as follows:</p>			
1	Format Attribute		Select the setting to be prioritized for the format attribute.
2	Pause Mode		Select the setting to be prioritized for pause mode.
3	1 Byte Codepage		Select the setting to be prioritized for the 1 byte code page.
4	SDPL Measure Unit		Select the setting to be prioritized for the measurement unit.
5	Scalable Font Style		Select the setting to be prioritized for the scalable font style.
6	Darkness		The option selected in the Printing > Advanced > Prioritize menu is applied to these settings and shown on this screen.
7	Factory Offset		
8	Speed		
9	Sensor Type		

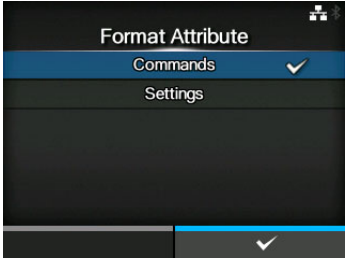
Format Attribute		
<p><i>Applications > SDPL > Prioritize > Format Attribute</i></p> <p>Set whether to prioritize the settings through the printer or through commands for the format attribute setting.</p> <p>The options are as follows:</p> <ul style="list-style-type: none"> • Commands: Prioritize the settings through commands. • Settings: Prioritize the settings through the printer. 		

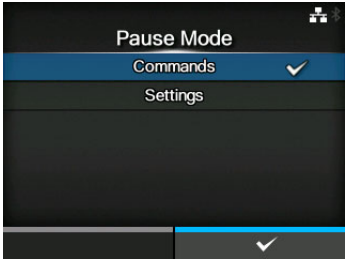
Pause Mode	
<p><i>Applications > SDPL > Prioritize > Pause Mode</i></p> <p>Set whether to prioritize the settings through the printer or through commands for the pause mode setting. The options are as follows:</p> <ul style="list-style-type: none"> • Commands: Prioritize the settings through commands. • Settings: Prioritize the settings through the printer. 	

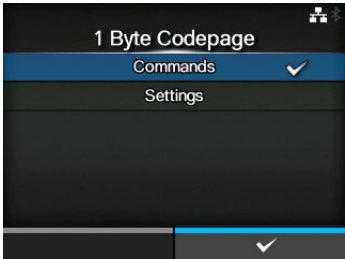
1 Byte Codepage	
<p><i>Applications > SDPL > Prioritize > 1 Byte Codepage</i></p> <p>Set whether to prioritize the settings through the printer or through commands for the 1 byte code page setting. The options are as follows:</p> <ul style="list-style-type: none"> • Commands: Prioritize the settings through commands. • Settings: Prioritize the settings through the printer. 	

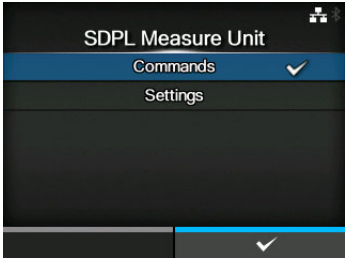
SDPL Measure Unit	
<p><i>Applications > SDPL > Prioritize > SDPL Measure Unit</i></p> <p>Set whether to prioritize the settings through the printer or through commands for the measurement unit setting. The options are as follows:</p> <ul style="list-style-type: none"> • Commands: Prioritize the settings through commands. • Settings: Prioritize the settings through the printer. 	

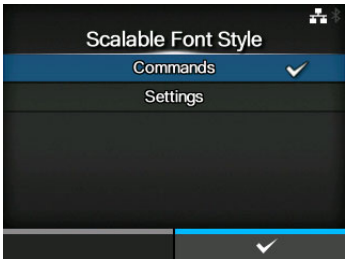
Scalable Font Style	
<p><i>Applications > SDPL > Prioritize > Scalable Font Style</i></p> <p>Set whether to prioritize the settings through the printer or through commands for the scalable font style settings. The options are as follows:</p> <ul style="list-style-type: none"> • Commands: Prioritize the settings through commands. • Settings: Prioritize the settings through the printer. 	

Format Attribute

Applications > SDPL > Format Attribute

Set the format attribute.

You can change this setting only if you have selected **Settings** in the **Prioritize > Format Attribute** menu.

The options are as follows:

- **XOR**
- **Transparent**
- **Opaque**
- **Inverse**

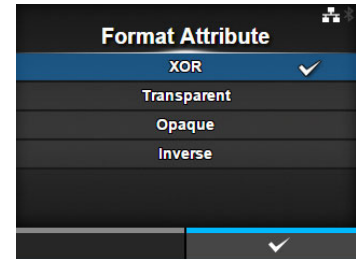

Pause Mode

Applications > SDPL > Pause Mode

Enable or disable the pause mode.

You can change this setting only if you have selected **Settings** in the **Prioritize > Pause Mode** menu.

The options are as follows:

- **Enabled**: Enable the pause mode.
- **Disabled**: Disable the pause mode.

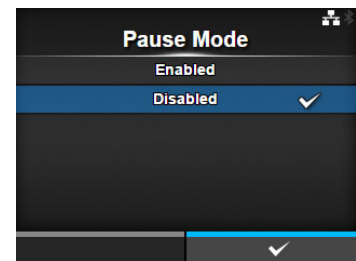

1 Byte Codepage

Applications > SDPL > 1 Byte Codepage

Select the code page to be used for 1 byte characters from the list.

You can change this setting only if you have selected **Settings** in the **Prioritize > 1 Byte Codepage** menu.

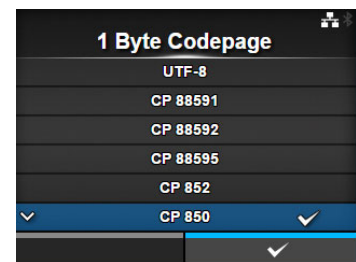

SDPL Measure Unit

Applications > SDPL > SDPL Measure Unit

Set the measurement unit.

You can change this setting only if you have selected **Settings** in the **Prioritize > SDPL Measure Unit** menu.

The options are as follows:

- **Inch**
- **Millimeter**

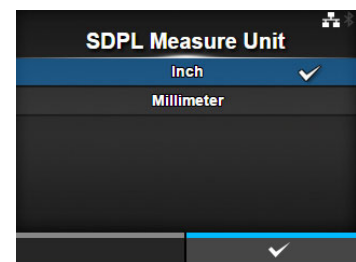

Scalable Font Style		
<p><i>Applications > SDPL > Scalable Font Style</i></p> <p>Set the style of the scalable fonts. You can change this setting only if you have selected Settings in the Prioritize > Scalable Font Style menu. The setting items are as follows:</p>		
1	<p>Bold</p> <p>Set whether to use bold.</p>	
2	<p>Italic</p> <p>Set whether to use italics.</p>	

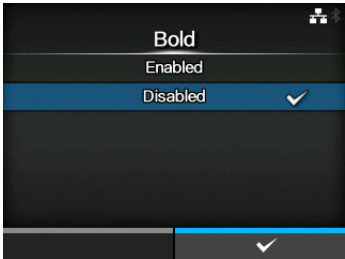
Bold	
<p><i>Applications > SDPL > Scalable Font Style > Bold</i></p> <p>Set whether to use bold for the scalable fonts. The options are as follows:</p> <ul style="list-style-type: none"> • Enabled: Use bold. • Disabled: Do not use bold. 	

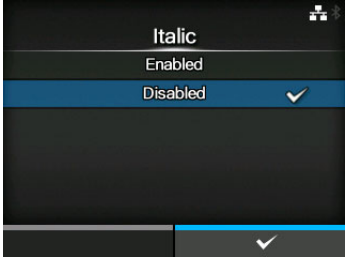
Italic	
<p><i>Applications > SDPL > Scalable Font Style > Italic</i></p> <p>Set whether to use italics for the scalable fonts. The options are as follows:</p> <ul style="list-style-type: none"> • Enabled: Use italics. • Disabled: Do not use italics. 	

SEPL

Applications > SEPL

To use SEPL as a printer command, set the following items:

1	Home Reference	Adjust the print reference position by specifying the offset position in the horizontal and vertical directions.
2	Memory Device	Select the printer's memory space in which to store forms, graphics and fonts.
3	Sim. 300 DPI Head	When you are using the printer with 305 dpi resolution, enable or disable 300 dpi simulation mode.

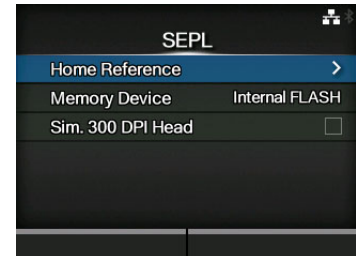

Home Reference

Applications > SEPL > Home Reference

Adjust the print reference position by specifying the offset position in the horizontal and vertical directions.

The setting items are as follows:

1	Horz. Offset	Specify the offset position in the horizontal direction.
2	Vert. Offset	Specify the offset position in the vertical direction.

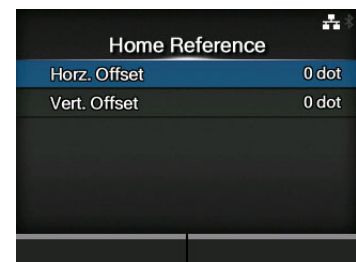

Horz. Offset

Applications > SEPL > Home Reference > Horz. Offset

Specify the offset position in the horizontal direction.
The setting range is from 0 to 400 dots.

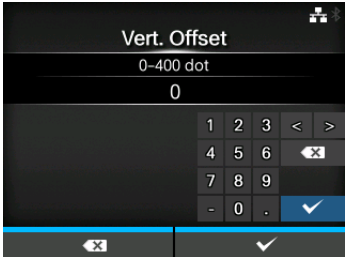

Vert. Offset	
<p><i>Applications > SEPL > Home Reference > Vert. Offset</i></p> <p>Specify the offset position in the vertical direction. The setting range is from 0 to 400 dots.</p>	

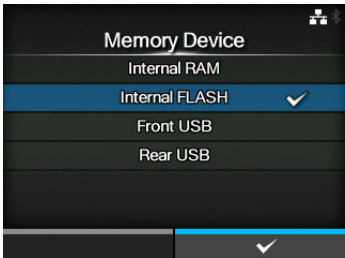
Memory Device	
<p><i>Applications > SEPL > Memory Device</i></p> <p>Select the printer's memory space in which to store forms, graphics and fonts. The options are as follows:</p> <ul style="list-style-type: none"> • Internal RAM: Use the printer's RAM. The data will be lost if the printer is powered off. • Internal FLASH: Use the printer's flash memory. • Front USB: Use the USB memory connected to the USB connector (Type A) on the front side of the printer. • Rear USB: Use the USB memory connected to the USB connector (Type A) on the rear side of the printer. <hr/> <p>CAUTION Be sure to perform a virus check for the USB memory before connecting it to the printer. SATO Corporation shall not be held responsible for any printer malfunctions caused by a virus spread via USB memory.</p> <hr/>	

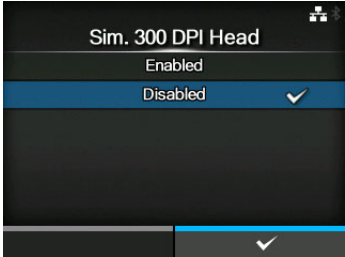
Sim. 300 DPI Head	
<p><i>Applications > SEPL > Sim. 300 DPI Head</i></p> <p>When you are using the printer with 305 dpi resolution, enable or disable 300 dpi simulation mode. The options are as follows:</p> <ul style="list-style-type: none"> • Enabled: Enable 300 dpi simulation mode. The sizes and positions of objects such as lines, boxes and barcodes in the print data are automatically adjusted to the equivalent 300 dpi sizes and positions for printing. • Disabled: Disable 300 dpi simulation mode. 	

AEP

Applications > AEP

Set the functions for AEP (Application Enabled Printing).
 AEP mode allows you to use the printer as a stand-alone printer by running applications within the printer.
 Use the standard application, or install custom applications to the printer from a USB memory, All-In-One Tool, WebConfig page, etc.
 In AEP mode, you can use USB keyboards and barcode scanners to input data.
 The setting items are as follows:

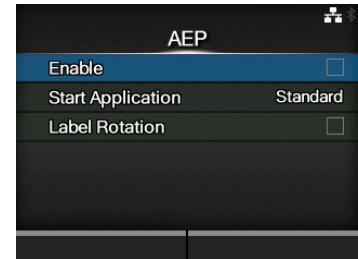

1	Enable	Enable or disable AEP mode.
2	Start Application	Select the application to start at printer startup in AEP mode.
3	Label Rotation	Set whether to rotate the page orientation for label printing.

Note

Contact your SATO sales representative for more information about the use of AEP mode.

Enable

Applications > AEP > Enable

Enable or disable AEP mode.
 The options are as follows:

- **Enabled:** Enable AEP mode.
- **Disabled:** Disable AEP mode.

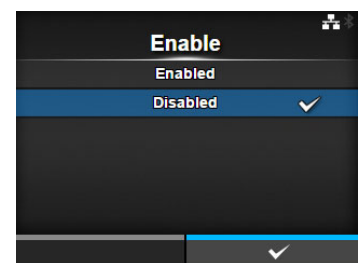

Note

The message prompting to restart the printer will appear on the online/offline screen if you have made any changes. In such a case, reboot the printer to make the setting effective.

Start Application

Applications > AEP > Start Application

Select the application to start at printer startup in AEP mode.
 Select the application using the ▲ / ▼ buttons and press the right soft button to confirm.

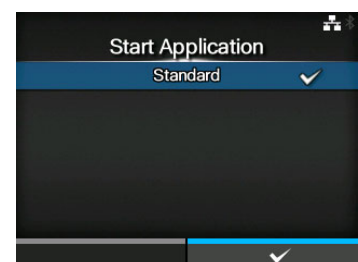

Label Rotation

Applications > AEP > Label Rotation

Set whether to rotate the page orientation for label printing.
The options are as follows:

- **Enabled:** Rotates the page orientation 180 degrees.
- **Disabled:** Does not rotate the page orientation.

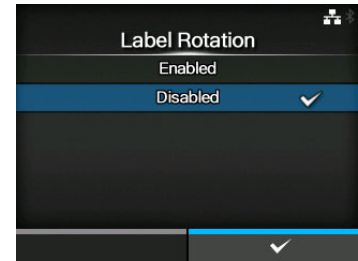

4.4.5 System Menu

In the **System** menu, there are setting items as follows:

System		
1	Regional	Set the display language, time zone, calendar and unit.
2	Notifications	Set the function to notify when to perform cleaning and parts replacement.
3	Sound	Set the buzzer sound.
4	Energy Saving	Set the period before the printer enters sleep mode.
5	LCD Brightness	Set the brightness of the screen.
6	Show Total Count	Enable or disable the indication of the total print count.
7	Password	Set the password.
8	Start on AC	Set whether to power on/off the printer by powering on/off the main power source.

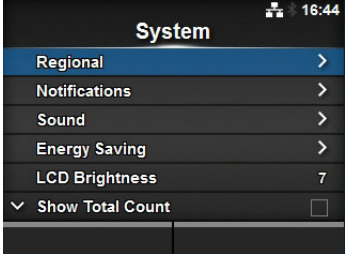

Regional		
<i>System > Regional</i>		
Set the display language, time zone, calendar and unit. The setting items are as follows:		
1	Messages	Set the display language of the LCD.
2	USB Keyboard	Set the language for the USB keyboard connected to the printer.
3	Locale	Set the locale to be used in AEP mode.
4	Unit	Set the unit of length for indication.
5	Time	Set the time. *You can set the time only if you have installed the optional RTC kit.
6	Date	Set the date. *You can set the date only if you have installed the optional RTC kit.
7	Time Zone	Set the time zone.

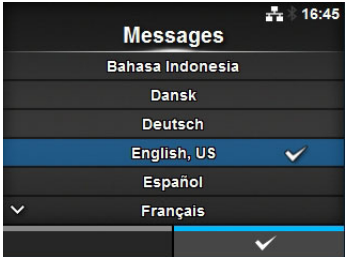

Messages	
<p><i>System > Regional > Messages</i></p> <p>Set the display language of the LCD. Select the display language from the list.</p>	

USB Keyboard	
<p><i>System > Regional > USB Keyboard</i></p> <p>Set the language for the USB keyboard connected to the printer. Select the USB keyboard layout from Western and Eastern European languages, Japanese, Chinese and Korean.</p>	

Locale	
<p><i>System > Regional > Locale</i></p> <p>Set the locale to be used in AEP mode. This setting determines the format of time, dates, numbers, prices, names of weekdays, months, etc. in AEP applications. Select the locale from the list.</p>	

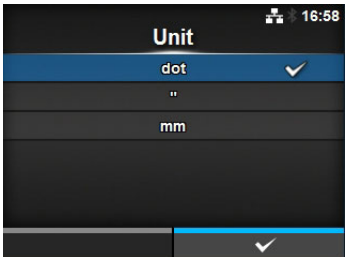
Unit	
<p><i>System > Regional > Unit</i></p> <p>Set the unit of length for indication. The options are as follows:</p> <ul style="list-style-type: none"> • dot • " (inch) • mm 	

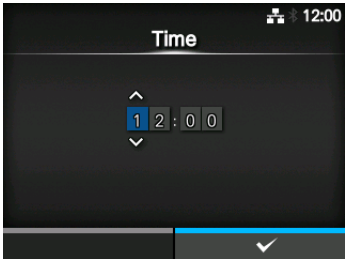
Time	
<p><i>System > Regional > Time</i></p> <p>Set the time. You can set the time only if you have installed the optional RTC kit.</p>	

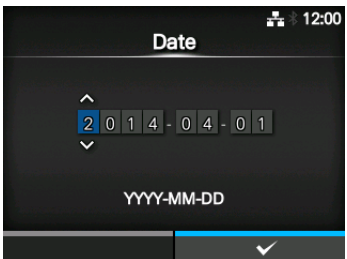
Date	
<p><i>System > Regional > Date</i></p> <p>Set the date. You can set the date only if you have installed the optional RTC kit. The setting range is from 2000-01-01 to 2035-12-31. *The date format is Year - Month - Date.</p>	

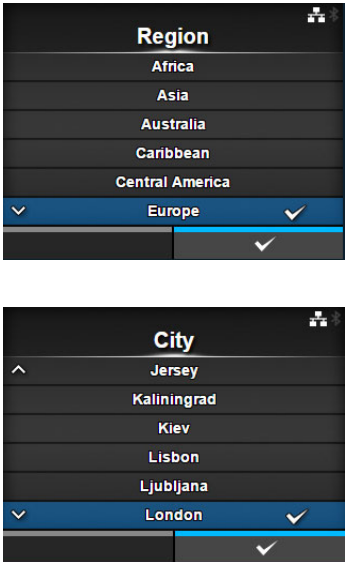
Time Zone	
<p><i>System > Regional > Time Zone > Region > City</i></p> <p>Set the time zone. First select the region from the Region list. Then select the city from the City list.</p>	

Notifications		
<p><i>System > Notifications</i></p> <p>Set the function to notify the timing of cleaning and parts replacement. The setting items are as follows:</p>		
1	Clean Printhead	Notify when the print head needs to be cleaned.
2	Change Printhead	Notify when the print head needs to be replaced.
3	Change Cutter	Notify when the cutter unit needs to be replaced.
4	Change Platen	Notify when the platen roller needs to be replaced.

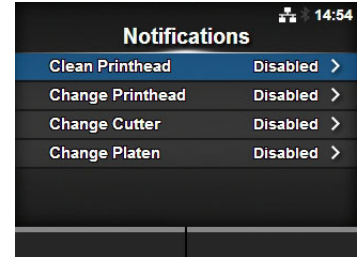

Clean Printhead		
<p><i>System > Notifications > Clean Printhead</i></p> <p>Notify when the print head needs to be cleaned. The setting items are as follows:</p>		
1	Clean Printhead	Enable or disable the notification function about when the print head needs to be cleaned.
2	Cleaning Interval	Set the notification interval about when the print head needs to be cleaned.
3	Clean Counter	Shows the current print distance.

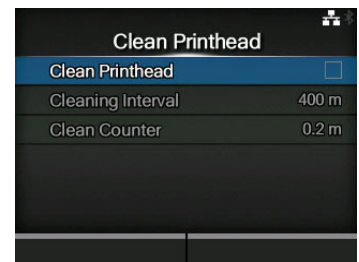

Clean Printhead		
<p><i>System > Notifications > Clean Printhead > Clean Printhead</i></p> <p>Enable or disable the notification function about when the print head needs to be cleaned. The options are as follows:</p> <ul style="list-style-type: none"> • Enabled: Enable the notification function. • Disabled: Disable the notification function. 		

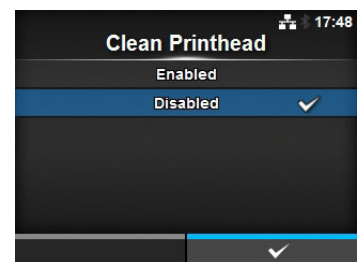

Cleaning Interval

System > Notifications > Clean Printhead > Cleaning Interval

Set the notification interval about when the print head needs to be cleaned. Available to change only if you have selected **Enabled** in the **Clean Printhead** menu.

The printer shows the print distance as a setting value. The setting range is from 10 to 1000 m.

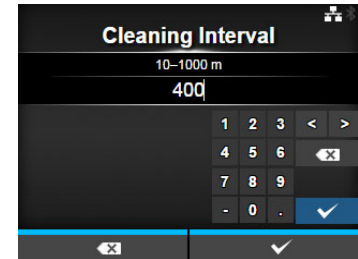

Change Printhead

System > Notifications > Change Printhead

Notify when the print head needs to be replaced. The setting items are as follows:

1	Change Printhead	Enable or disable the notification function about when the print head needs to be replaced.
2	Printhead Interval	Set the notification interval about when the print head needs to be replaced.
3	Printhead Count	Shows the current print distance.

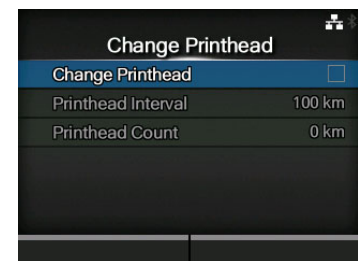

Change Printhead

System > Notifications > Change Printhead > Change Printhead

Enable or disable the notification function about when the print head needs to be replaced.

The options are as follows:

- **Enabled:** Enable the notification function.
- **Disabled:** Disable the notification function.

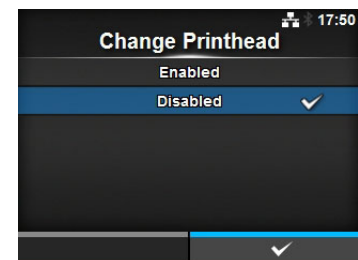

Printhead Interval

System > Notifications > Change Printhead > Printhead Interval

Set the notification interval about when the print head needs to be replaced.

Available to change only if you have selected **Enabled** in the **Change Printhead** menu.

The printer shows the print distance as the setting value. The setting range is from 10 to 100 km.

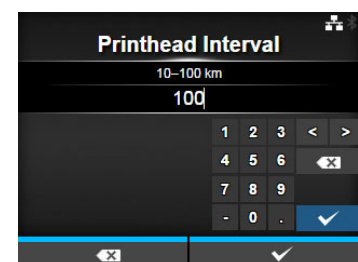

Change Cutter		
<p><i>System > Notifications > Change Cutter</i></p> <p>Notify when the cutter unit needs to be replaced. The setting items are as follows:</p>		
1	Change Cutter	Enable or disable the notification function about when the cutter unit needs to be replaced.
2	Cutter Life	Set the notification interval about when the cutter unit needs to be replaced.
3	Cutter Count	Shows the current number of cuts by the cutter.

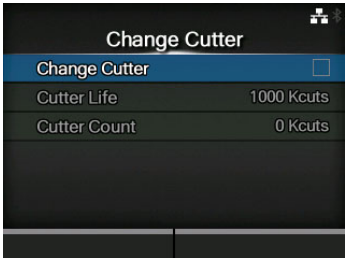

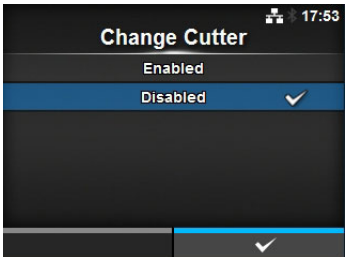
Change Cutter	
<p><i>System > Notifications > Change Cutter > Change Cutter</i></p> <p>Enable or disable the notification function about when the cutter unit needs to be replaced. The options are as follows:</p> <ul style="list-style-type: none"> • Enabled: Enable the notification function. • Disabled: Disable the notification function. 	

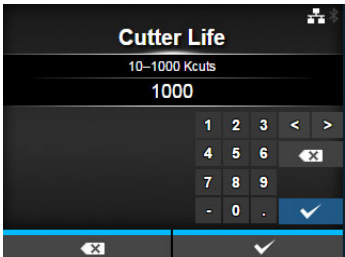
Cutter Life	
<p><i>System > Notifications > Change Cutter > Cutter Life</i></p> <p>Set the notification interval about when the cutter unit needs to be replaced. Available to change only if you have selected Enabled in the Change Cutter menu. The printer shows the cutter count as the setting value. The setting range is from 10 to 1000 Kcuts.</p>	

Change Platen		
<p><i>System > Notifications > Change Platen</i></p> <p>Notify when the platen roller needs to be replaced. The setting items are as follows:</p>		
1	Change Platen	Enable or disable the notification function about when the platen roller needs to be replaced.
2	Platen Interval	Set the notification interval about when the platen roller needs to be replaced.
3	Platen Count	Shows the current distance the platen roller has fed.

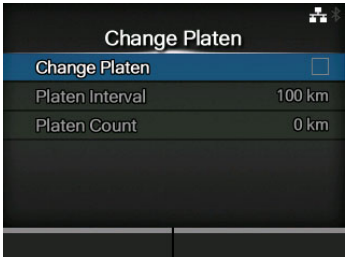

Change Platen

System > Notifications > Change Platen > Change Platen

Enable or disable the notification function about when the platen roller needs to be replaced.

The options are as follows:

- **Enabled:** Enable the notification function.
- **Disabled:** Disable the notification function.

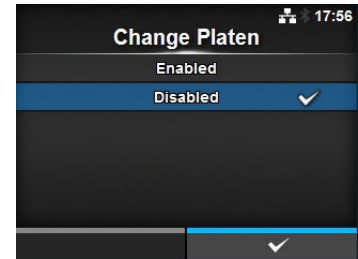

Platen Interval

System > Notifications > Change Platen > Platen Interval

Set the notification interval about when the platen roller needs to be replaced.

Available to change only if you have selected **Enabled** in the **Change Platen** menu.

The printer shows the fed distance as the setting value.

The setting range is from 10 to 100 km.

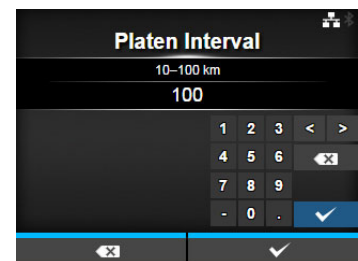

Sound

System > Sound

Set the buzzer sound.

The setting item is as follows:

1	Error Sound	Set the buzzer volume for the error sound.
---	-------------	--

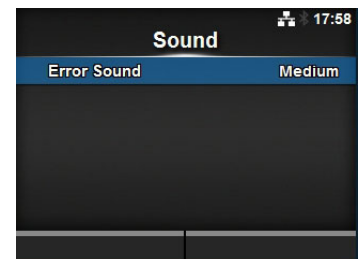

Error Sound

System > Sound > Error Sound

Set the buzzer volume for the error sound.

The options are as follows:

- **Off:** Mute the sound.
- **Low:** Low volume.
- **Medium:** Medium volume.
- **High:** High volume.

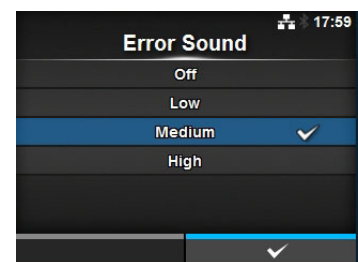

Energy Saving		
<p><i>System > Energy Saving</i></p> <p>The setting item is as follows:</p>		
1	Sleep Timeout	Set the period before the printer enters sleep mode.

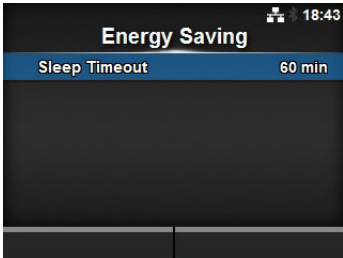

Sleep Timeout	
<p><i>System > Energy Saving > Sleep Timeout</i></p> <p>Set the period before the printer enters sleep mode. The setting range is from 0 to 60 minutes.</p>	
<p>Note</p> <ul style="list-style-type: none"> • The sleep function is disabled if you set to 0. • This setting is disabled if External I/O on page 161 is enabled. 	

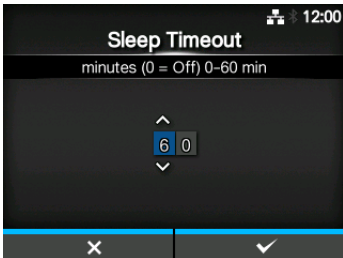

LCD Brightness	
<p><i>System > LCD Brightness</i></p> <p>Set the brightness of the screen. The setting range is from 0 to 9. 0 is the darkest and 9 is the brightest. Press the right soft button to complete the setting.</p>	
<p>Note</p> <p>The printer has a built-in energy saving function, which will decrease the brightness of the screen when you have not operated the printer for a period.</p>	

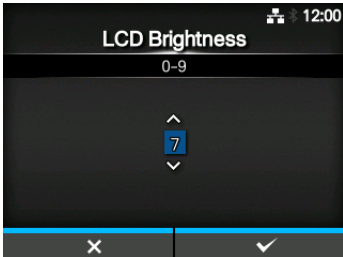

Show Total Count

System > Show Total Count

Enable or disable the indication of the total print count.
If set to **Enabled**, the total print count shows on both the Online and Offline screens.
The number in the brackets to the right of "QTY" on the Online and Offline screens is the total print count.
The options are as follows:

- **Enabled**: Enable the indication of the total print count.
- **Disabled**: Disable the indication of the total print count.

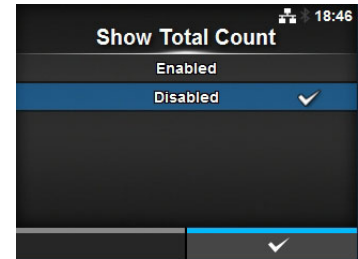

Note

Shows the total print count from the time the printer is on until it is off.
When you power off the printer, the count resets to 0.

Password

System > Password

The setting items are as follows:

1	Password Enable	Enable or disable the password setting.
2	Install Security	Enable or disable the password input for the package file download.
3	NFC Security	Set whether to show the confirmation message or enable the password input before settings are written to the printer from an Android device with the NFC interface.
4	Change Password	Change the password.

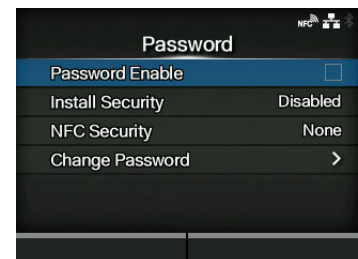

Password Enable

System > Password > Password Enable

Enable or disable the password setting.
If you have set the password to **Enabled**, the printer requires you to enter the password set in the **Password** screen before you enter the **Settings** menu.
The options are as follows:

- **Enabled**: Enable the password setting.
- **Disabled**: Disable the password setting.

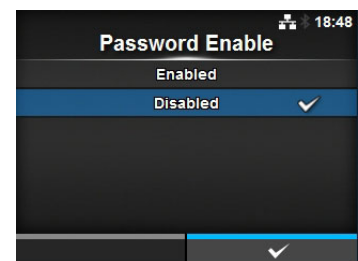

Note

The default password is 0310. You can change the password in *Password > Change Password > level1*.

Install Security	
<p><i>System > Password > Install Security</i></p> <p>Enable or disable the password input for installing the pkg file to the printer. If you have enabled the password input, the printer requires you to enter the password set in the Password screen before you can download the package file. The options are as follows:</p> <ul style="list-style-type: none"> • Disabled: No password is required to install a pkg file. • USB: Password is required to install a pkg file from the USB memory. • Always: Password is required to install a pkg file from the USB memory or downloaded from computer. <hr/> <p>Note The password used for installing a pkg file can be any passwords set in the <i>System > Password</i>. Contact a SATO reseller or technical service center for more information of the pkg file.</p>	

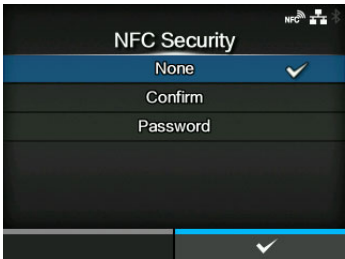
NFC Security	
<p><i>System > Password > NFC Security</i></p> <p>Set whether to show the confirmation message or enable the password input before settings are written to the printer from an Android device with the NFC interface. To use the NFC Security function, the settings must be written from the Android device while the printer is powered off. The confirmation message or password input screen is shown when the printer is powered on. The options are as follows:</p> <ul style="list-style-type: none"> • None: No confirmation message is shown and no password is required before the settings are written to the printer. • Confirm: The confirmation message is shown before the settings are written to the printer. • Password: You need to enter the password set in the Password screen before the settings are written to the printer. 	

Change Password

System > Password > Change Password

Change the password.

You can enter 4 to 32 characters including alphabet (capital and small letters), numbers and symbols.

The setting items are as follows:

- **admin:** This is the setting item for factory.
Strictly for SATO authorized personnel use.
- **manager:** The password for accessing the **Service** menu.
Strictly for SATO authorized personnel use.
- **level1:** The password for accessing the **Settings** menu.
- **rfid:** This is the setting item for factory.
Strictly for SATO authorized personnel use.

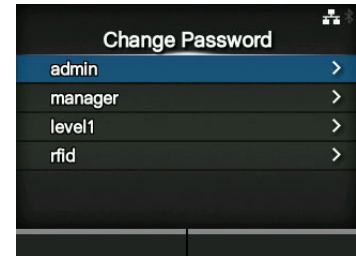

Note

The admin, manager and rfid passwords are for factory and maintenance personnel. You cannot change these passwords.

Start on AC

System > Start on AC

Set whether to power on/off the printer by powering on/off the main power source.

The options are as follows:

- **Enabled:** Power on/off the printer by powering on/off the main power source.
- **Disabled:** Power on/off the printer by pressing the  power button of the printer.

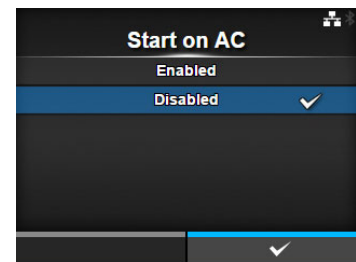

CAUTION

- Do not repeatedly power on and off the printer.
- If you power the main power source off and then on again quickly, the printer may not be powered on because it is still in the powering off process. In such a case, press the  power button to power on the printer.
- Do not power off the printer during operation, such as when printing or updating. Doing so could cause a malfunction of the printer.
- Do not disconnect the power cord until the powering off process is completed on the printer.
- An incorrect power on/off operation may damage the printer settings. In such a case, the printer settings are reset to their default values.

4.4.6 Tools Menu

In the **Tools** menu, there are setting items as follows:

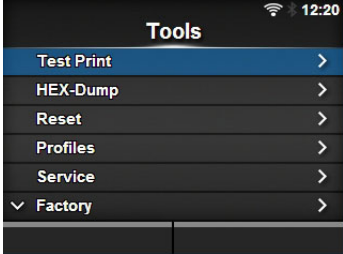

Tools		
1	Test Print	Perform a test print.
2	HEX-Dump	Save the hex dump print data or dump data from the receive buffer to the USB memory.
3	Reset	Initialize the configuration or counter of the printer.
4	Profiles	Utilize the printer configurations as profiles.
5	Service	These are the setting items for service. Strictly for SATO authorized service personnel use.
6	Factory	These are the setting items for factory. Strictly for SATO factory personnel use.
7	Certificates	Set the wireless LAN authentication. * Available only if you have installed the USB memory.
8	Barcode Checker	Set the barcode check function using a barcode checker.
9	Clone	Copy the current printer settings and data to the USB memory. * Available only if you have installed the USB memory.
10	Startup Guide	Enable or disable the startup guide.

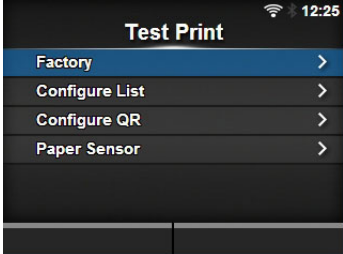

Test Print		
<p><i>Tools > Test Print</i></p> <p>Perform a test print. The setting items are as follows:</p>		
1	Factory	Perform the factory test print.
2	Configure List	Print the configuration information of the printer.
3	Configure QR	Print the configuration information with a QR code.
4	Paper Sensor	Print the detection result of the media sensor level.

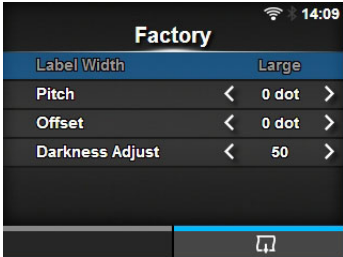

Factory				
<p><i>Tools > Test Print > Factory</i></p> <p>Perform the factory test print.</p> <ol style="list-style-type: none"> 1. Check and set the items as listed on the Factory menu. 2. Press the right soft button to start the test print. Press the right soft button again to pause the print. <p>To stop the test print, first pause the print and then press the  button.</p> <p>The setting items are as follows:</p>				
1	Label Width		Shows the necessary media width of the test print. The necessary media width is 101.6 mm (4") for Large .	
2	Pitch		Set the print position in the vertical direction. The setting range varies depending on the print resolution of the printer. The setting range is as follows: <CL4NX> <ul style="list-style-type: none"> • 203 dpi: -30 to 0 to 30 dots • 305 dpi: -45 to 0 to 45 dots • 609 dpi: -90 to 0 to 90 dots <CL6NX> <ul style="list-style-type: none"> • 203 dpi: -30 to 0 to 30 dots • 305 dpi: -45 to 0 to 45 dots When you decrease the setting value, the print position moves in the feed direction (toward the front part of the media). When you increase the setting value, the print position moves opposite the feed direction (toward the end part of the media).	<p>Note</p> <p>The value of Pitch, Offset and Darkness Adjust set in the Factory menu will reflect to the same item settings in the Configure List menu, Configure QR menu and Paper Sensor menu.</p>
3	Offset		Set the stop position of the media. The setting range varies depending on the print resolution of the printer. The setting range is as follows: <CL4NX> <ul style="list-style-type: none"> • 203 dpi: -30 to 0 to 30 dots • 305 dpi: -45 to 0 to 45 dots • 609 dpi: -90 to 0 to 90 dots <CL6NX> <ul style="list-style-type: none"> • 203 dpi: -30 to 0 to 30 dots • 305 dpi: -45 to 0 to 45 dots When you decrease the setting value, the stop position moves in the feed direction (toward the front part of the media). When you increase the setting value, the stop position moves opposite the feed direction (toward the end part of the media).	
4	Darkness Adjust		Fine tune the print darkness of the test print. 0 is the lightest and 99 is the darkest.	

Configure List			
<p><i>Tools > Test Print > Configure List</i></p> <p>Print the configuration information of the printer.</p> <ol style="list-style-type: none"> 1. Check and set the items as listed on the Configure List menu. 2. Press the right soft button to start the test print. Press the right soft button again to pause the print. <p>To stop the test print, first pause the print and then press the  button.</p> <p>The setting items are as follows:</p>			
1	Label Width		<p>Shows the necessary media width of the test print.</p> <p>The necessary media width is 50.8 mm (2") for Small.</p>
2	Label Length	<p>Set the length of one piece of the media used for the test print.</p> <p>The setting range varies depending on the print resolution of the printer.</p> <p>The setting range is as follows:</p> <p><CL4NX></p> <ul style="list-style-type: none"> • 203 dpi: 400 to 1600 dots • 305 dpi: 600 to 2400 dots • 609 dpi: 1200 to 4800 dots <p><CL6NX></p> <ul style="list-style-type: none"> • 203 dpi: 400 to 1600 dots • 305 dpi: 600 to 2400 dots 	<p>Note</p> <p>The value of Label Length, Pitch, Offset and Darkness Adjust set in the Configure List menu will reflect to the same item settings in the Factory menu, Configure QR menu and Paper Sensor menu.</p>
3	Pitch	<p>Set the print position in the vertical direction.</p> <p>The setting range varies depending on the print resolution of the printer.</p> <p>The setting range is as follows:</p> <p><CL4NX></p> <ul style="list-style-type: none"> • 203 dpi: -30 to 0 to 30 dots • 305 dpi: -45 to 0 to 45 dots • 609 dpi: -90 to 0 to 90 dots <p><CL6NX></p> <ul style="list-style-type: none"> • 203 dpi: -30 to 0 to 30 dots • 305 dpi: -45 to 0 to 45 dots <p>When you decrease the setting value, the print position moves in the feed direction (toward the front part of the media).</p> <p>When you increase the setting value, the print position moves opposite the feed direction (toward the end part of the media).</p>	

Configure List		
4	Offset	<p>Set the stop position of the media. The setting range varies depending on the print resolution of the printer. The setting range is as follows:</p> <p><CL4NX></p> <ul style="list-style-type: none"> • 203 dpi: -30 to 0 to 30 dots • 305 dpi: -45 to 0 to 45 dots • 609 dpi: -90 to 0 to 90 dots <p><CL6NX></p> <ul style="list-style-type: none"> • 203 dpi: -30 to 0 to 30 dots • 305 dpi: -45 to 0 to 45 dots <p>When you decrease the setting value, the stop position moves in the feed direction (toward the front part of the media). When you increase the setting value, the stop position moves opposite the feed direction (toward the end part of the media).</p>
5	Darkness Adjust	<p>Fine tune the print darkness of the test print. 0 is the lightest and 99 is the darkest.</p>

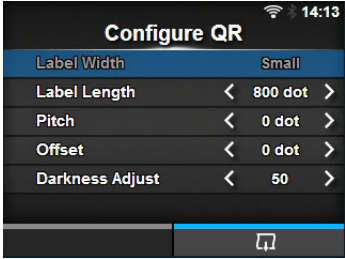
Configure QR		
<p><i>Tools > Test Print > Configure QR</i></p> <p>Print the configuration information with a QR code.</p> <ol style="list-style-type: none"> 1. Check and set the items as listed on the Configure QR menu. 2. Press the right soft button to start the test print. Press the right soft button again to pause the print. <p>To stop the test print, first pause the print and then press the  button. The setting items are as follows:</p>		
1	Label Width	

Configure QR			
2	Label Length	<p>Set the length of one piece of the media used for the test print. The setting range varies depending on the print resolution of the printer. The setting range is as follows:</p> <p><CL4NX></p> <ul style="list-style-type: none"> • 203 dpi: 400 to 1600 dots • 305 dpi: 600 to 2400 dots • 609 dpi: 1200 to 4800 dots <p><CL6NX></p> <ul style="list-style-type: none"> • 203 dpi: 400 to 1600 dots • 305 dpi: 600 to 2400 dots 	<hr/> <p>Note The value of Label Length, Pitch, Offset and Darkness Adjust set in the Configure QR menu will reflect to the same item settings in the Factory menu, Configure List menu and Paper Sensor menu.</p> <hr/>
3	Pitch	<p>Set the print position in the vertical direction. The setting range varies depending on the print resolution of the printer. The setting range is as follows:</p> <p><CL4NX></p> <ul style="list-style-type: none"> • 203 dpi: -30 to 0 to 30 dots • 305 dpi: -45 to 0 to 45 dots • 609 dpi: -90 to 0 to 90 dots <p><CL6NX></p> <ul style="list-style-type: none"> • 203 dpi: -30 to 0 to 30 dots • 305 dpi: -45 to 0 to 45 dots <p>When you decrease the setting value, the print position moves in the feed direction (toward the front part of the media). When you increase the setting value, the print position moves opposite the feed direction (toward the end part of the media).</p>	
4	Offset	<p>Set the stop position of the media. The setting range varies depending on the print resolution of the printer. The setting range is as follows:</p> <p><CL4NX></p> <ul style="list-style-type: none"> • 203 dpi: -30 to 0 to 30 dots • 305 dpi: -45 to 0 to 45 dots • 609 dpi: -90 to 0 to 90 dots <p><CL6NX></p> <ul style="list-style-type: none"> • 203 dpi: -30 to 0 to 30 dots • 305 dpi: -45 to 0 to 45 dots <p>When you decrease the setting value, the stop position moves in the feed direction (toward the front part of the media). When you increase the setting value, the stop position moves opposite the feed direction (toward the end part of the media).</p>	
5	Darkness Adjust	<p>Fine tune the print darkness of the test print. 0 is the lightest and 99 is the darkest.</p>	

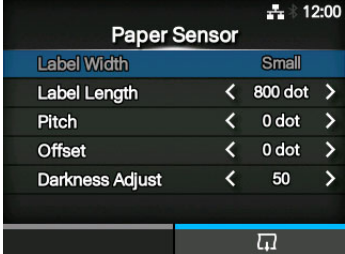
Paper Sensor		
<p><i>Tools > Test Print > Paper Sensor</i></p> <p>Print the detection result of the media sensor level.</p> <ol style="list-style-type: none"> 1. Check and set the items as listed on the Paper Sensor menu. 2. Press the right soft button to start the test print. Press the right soft button again to pause the print. <p>To stop the test print, first pause the print and then press the  button. The setting items are as follows:</p>		
1	<p>Label Width</p> <p>Shows the necessary media width of the test print. The necessary media width is 101.6 mm (4") for Large and 50.8 mm (2") for Small.</p>	
2	<p>Label Length</p> <p>Set the length of one piece of the media used for the test print. The setting range varies depending on the print resolution of the printer. The setting range is as follows:</p> <p><CL4NX></p> <ul style="list-style-type: none"> • 203 dpi: 400 to 1600 dots • 305 dpi: 600 to 2400 dots • 609 dpi: 1200 to 4800 dots <p><CL6NX></p> <ul style="list-style-type: none"> • 203 dpi: 400 to 1600 dots • 305 dpi: 600 to 2400 dots 	<p>Note The value of Label Length, Pitch, Offset and Darkness Adjust set in the Paper Sensor menu will reflect to the same item settings in the Factory menu, Configure List menu and Configure QR menu.</p>
3	<p>Pitch</p> <p>Set the print position in the vertical direction. The setting range varies depending on the print resolution of the printer. The setting range is as follows:</p> <p><CL4NX></p> <ul style="list-style-type: none"> • 203 dpi: -30 to 0 to 30 dots • 305 dpi: -45 to 0 to 45 dots • 609 dpi: -90 to 0 to 90 dots <p><CL6NX></p> <ul style="list-style-type: none"> • 203 dpi: -30 to 0 to 30 dots • 305 dpi: -45 to 0 to 45 dots <p>When you decrease the setting value, the print position moves in the feed direction (toward the front part of the media). When you increase the setting value, the print position moves opposite the feed direction (toward the end part of the media).</p>	

Paper Sensor		
4	Offset	<p>Set the stop position of the media. The setting range varies depending on the print resolution of the printer. The setting range is as follows:</p> <p><CL4NX></p> <ul style="list-style-type: none"> • 203 dpi: -30 to 0 to 30 dots • 305 dpi: -45 to 0 to 45 dots • 609 dpi: -90 to 0 to 90 dots <p><CL6NX></p> <ul style="list-style-type: none"> • 203 dpi: -30 to 0 to 30 dots • 305 dpi: -45 to 0 to 45 dots <p>When you decrease the setting value, the stop position moves in the feed direction (toward the front part of the media). When you increase the setting value, the stop position moves opposite the feed direction (toward the end part of the media).</p>
5	Darkness Adjust	<p>Fine tune the print darkness of the test print. 0 is the lightest and 99 is the darkest.</p>

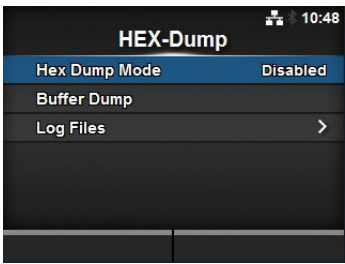
HEX-Dump			
<i>Tools > HEX-Dump</i>			
<p>Save the hex dump print data or dump data from the receive buffer to the USB memory. The setting items are as follows:</p>			
1	Hex Dump Mode		Enable or disable the Hex Dump mode.
2	Buffer Dump		Save the receive buffer data to the printer.
3	Log Files	Manage the log files of the printer.	

Hex Dump Mode

Tools > HEX-Dump > Hex Dump Mode

Enable or disable the Hex Dump mode.
If you set the Hex Dump mode to **Enabled**, the printer prints the received data and at the same time creates a file of the received data inside “hexdump”.
When you return the setting to **Disabled**, you can check the file on the screen.

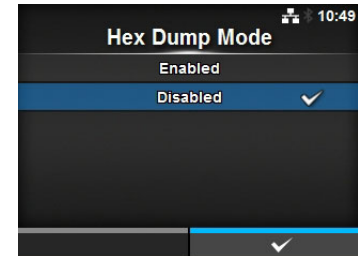

Note

- If you set the Hex Dump mode to **Enabled**, the design of the online/offline screen changes.
- You can save a maximum of ten received data files for each type of interface. Depending on the file size, the number of files you can save will be less than ten.
- The details of the files created inside “hexdump” are as follows:
 - **BT00xx.bin**: Received data through Bluetooth.
 - **LAN00xx.bin**: Received data through LAN.
 - **LPT00xx.bin**: Received data through IEEE1284.
 - **NFC00xx.bin**: Received data through NFC.
 - **PIPE00xx.bin**: Received data through pipe.
 - **SCI00xx.bin**: Received data through RS-232C.
 - **USB00xx.bin**: Received data through USB.
 - **WIFI00xx.bin**: Received data through Wi-Fi.

Buffer Dump

Tools > HEX-Dump > Buffer Dump

Save the receive buffer data to the printer.
Available only if you have set to **Disabled** in the **Hex Dump Mode** menu.
Press the **START** (right soft) button on the startup screen to save the data to the printer.
Save the receive buffer data to “buff”.

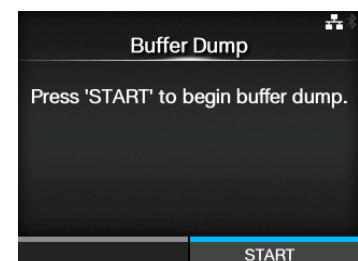

Note

- The data files of the receive buffer are created for each type of interface.
- The details of the file created inside “buff” are as follows:
 - **BT0001.bin**: The contents of the receive buffer for Bluetooth.
 - **LAN0001.bin**: The contents of the receive buffer for LAN.
 - **LPT0001.bin**: The contents of the receive buffer for IEEE1284.
 - **NFC0001.bin**: The contents of the receive buffer for NFC.
 - **PIPE0001.bin**: The contents of the receive buffer for pipe.
 - **SCI0001.bin**: The contents of the receive buffer for RS-232C.
 - **USB0001.bin**: The contents of the receive buffer for USB.
 - **WIFI0001.bin**: The contents of the received buffer for Wi-Fi.
- If you perform the **Buffer Dump** again, the existing file will be overwritten.

Log Files		
<p><i>Tools > HEX-Dump > Log Files</i></p> <p>The setting items are as follows:</p>		
1	Copy	Copy the log files of the printer to the USB memory. * Available only if you have installed the USB memory.
2	Remove	Delete the log files of the printer.
3	Print	Print a hex dump of the log files of the printer.

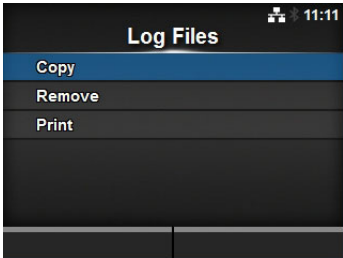

Copy	
<p><i>Tools > HEX-Dump > Log Files > Copy</i></p> <p>Copy the log files of the printer to the USB memory. Available only if you have installed the USB memory. The procedure to copy the log files is as follows:</p> <ol style="list-style-type: none"> Select the file type to copy and press the ← button. <ul style="list-style-type: none"> buff/: The buffer data saved after you perform the Buffer Dump. hexdump/: The received data created through Hex Dump Mode. Select the file to copy and press the ← button. A checkmark shows on the right side of the file name. After you select the file, press the right soft button to copy the selected file to the USB memory. 	
<p>CAUTION Be sure to perform a virus check for the USB memory before connecting it to the printer. SATO Corporation shall not be held responsible for any printer malfunctions caused by a virus spread via USB memory.</p>	
<p>Note When Hex Dump Mode is set to Enabled, it may take some time before the files are shown.</p>	

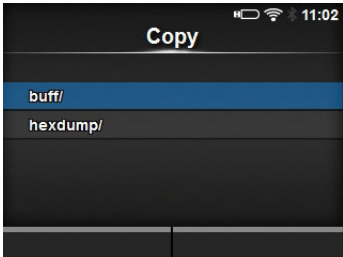
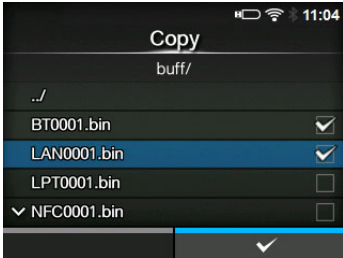



Remove

Tools > HEX-Dump > Log Files > Remove

Delete the log files of the printer.

The procedure to delete the log files is as follows:

1. Select the file type to delete and press the  button.
 - **buff/**: The buffer data saved after you perform the **Buffer Dump**.
 - **hexdump/**: The received data created through **Hex Dump Mode**.
2. Select the file to delete and press the  button. A checkmark shows on the right side of the file name.
3. After you select the file, press the right soft button to delete the selected file.

Note

When **Hex Dump Mode** is set to **Enabled**, it may take some time before the files are shown.

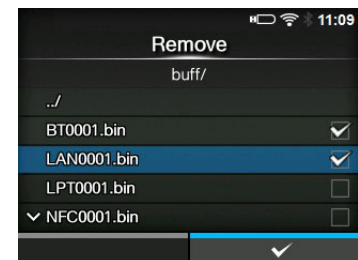
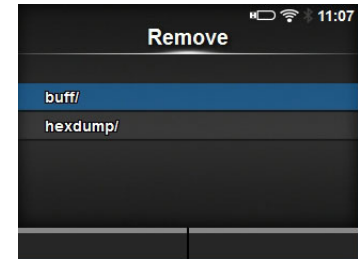



Print

Tools > HEX-Dump > Log Files > Print

Print a hex dump of the log files of the printer.

The procedure to print the log files is as follows:

1. Select the file type to print and press the  button.
 - **buff/**: The buffer data saved after you perform the **Buffer Dump**.
 - **hexdump/**: The received data created through **Hex Dump Mode**.
2. Select the file to print and press the  button or right soft button to perform the dump print.

CAUTION

Printing the contents of the file may use a lot of media.

Note

When **Hex Dump Mode** is set to **Enabled**, it may take some time before the files are shown.

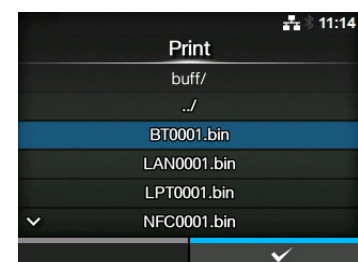
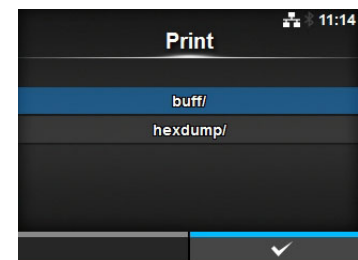

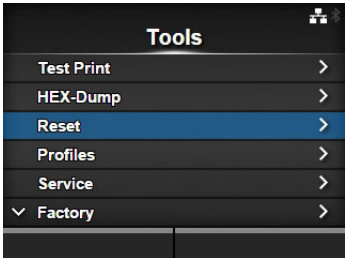
Reset	
<p><i>Tools > Reset</i></p> <p>Enter the screen for selecting the items to be initialized.</p>	

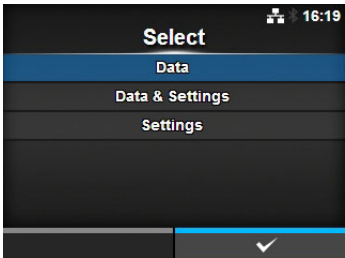
Select										
<p><i>Tools > Reset > Select</i></p> <p>Select the items to be initialized. The items are as follows:</p> <table border="1" style="width: 100%; border-collapse: collapse;"> <tr> <td style="width: 5%; text-align: center;">1</td> <td style="width: 20%;">Data</td> <td>Initialize the data saved in the printer.</td> </tr> <tr> <td style="text-align: center;">2</td> <td>Data & Settings</td> <td>Initialize the data and setting values of the printer.</td> </tr> <tr> <td style="text-align: center;">3</td> <td>Settings</td> <td>Initialize the setting values of the printer.</td> </tr> </table>	1	Data	Initialize the data saved in the printer.	2	Data & Settings	Initialize the data and setting values of the printer.	3	Settings	Initialize the setting values of the printer.	
1	Data	Initialize the data saved in the printer.								
2	Data & Settings	Initialize the data and setting values of the printer.								
3	Settings	Initialize the setting values of the printer.								

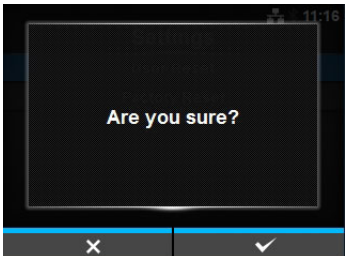
Data	
<p><i>Tools > Reset > Select > Data</i></p> <p>Initialize the data saved in the printer. The data to be initialized are the fonts and graphics registered in the printer. When you select Data, the confirmation screen shows. Press the left soft button to cancel or right soft button to perform the initialization. The printer will reboot after reset.</p> <hr/> <p>CAUTION It is generally not necessary to perform the initialization. Doing so could change the print conditions.</p>	

Data & Settings

Tools > Reset > Select > Data & Settings

Initialize the data and setting values of the printer.

Select the setting items to be initialized.

The options are as follows:

- **User Reset:** Initialize the data and setting values.
- **User Reset (-Interface):** Initialize the data and setting values that are not included in the **Interface** menu.
- **Factory Reset:** Initialize to the status after factory shipment.
- **Factory Reset (-Interface):** Initialize the items that are not included in the **Interface** menu to the status after factory shipment.
- **Interface:** Initialize the data and setting values in the **Interface** menu.
- **Printing:** Initialize the data and setting values in the **Printing** menu.

Select the item to be initialized using the ▲/ ▼ buttons, then press the right soft button to perform the initialization.

The confirmation screen shows.

Press the left soft button to cancel or right soft button to perform the initialization.

The printer will reboot after reset.

Refer to [Section 7.1 List of Initial Values](#) for the initial value of each setting items.

Note

The data to be initialized are the fonts and graphics registered in the printer.

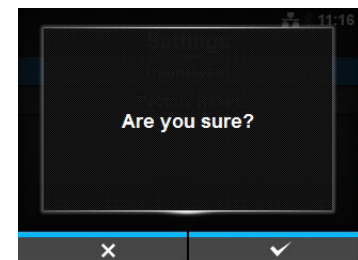
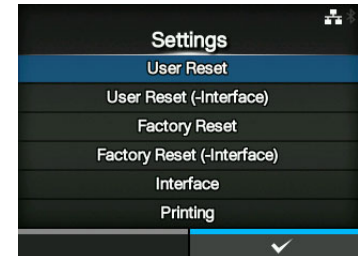

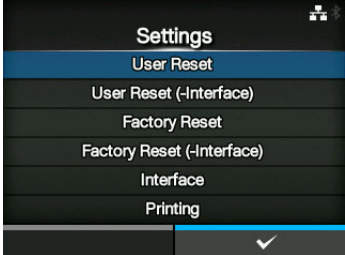
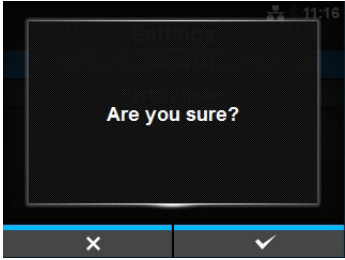
Settings	
<p><i>Tools > Reset > Select > Settings</i></p> <p>Select the setting items to be initialized. The options are as follows:</p> <ul style="list-style-type: none"> • User Reset: Initialize the setting values. • User Reset (-Interface): Initialize the setting values that are not included in the Interface menu. • Factory Reset: Initialize to the status after factory shipment. • Factory Reset (-Interface): Initialize the items that are not included in the Interface menu to the status after factory shipment. • Interface: Initialize the setting values in the Interface menu. • Printing: Initialize the setting values in the Printing menu. <p>Select the item to be initialized using the ▲/ ▼ buttons, then press the right soft button to perform the initialization. The confirmation screen shows. Press the left soft button to cancel or right soft button to perform the initialization. If the message prompting to restart the printer appears on the online/offline screen, reboot the printer to make the setting effective.</p> <p>Refer to Section 7.1 List of Initial Values for the initial value of each setting item.</p>	 

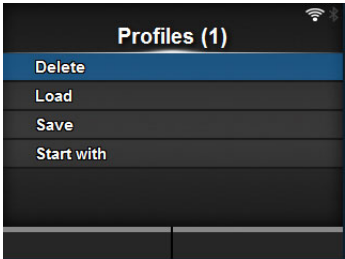
Profiles												
<p><i>Tools > Profiles</i></p> <p>Maintain the customized profile of the printer configurations. The name of the last loaded profile is shown in the parenthesis. The setting items are as follows:</p>												
1	<table border="1"> <tr> <td style="width: 150px;">Delete</td> <td>Delete the profile of the printer. *Not available if no profile is saved.</td> </tr> <tr> <td>2</td> <td>Load</td> <td>Load the profile of the printer. *Not available if no profile is saved.</td> </tr> <tr> <td>3</td> <td>Save</td> <td>Save the current printer configurations as a new profile.</td> </tr> <tr> <td>4</td> <td>Start with</td> <td>Select the profile to load at printer startup. *Not available if no profile is saved.</td> </tr> </table>	Delete	Delete the profile of the printer. *Not available if no profile is saved.	2	Load	Load the profile of the printer. *Not available if no profile is saved.	3	Save	Save the current printer configurations as a new profile.	4	Start with	Select the profile to load at printer startup. *Not available if no profile is saved.
Delete	Delete the profile of the printer. *Not available if no profile is saved.											
2	Load	Load the profile of the printer. *Not available if no profile is saved.										
3	Save	Save the current printer configurations as a new profile.										
4	Start with	Select the profile to load at printer startup. *Not available if no profile is saved.										
												

Delete

Tools > Profiles > Delete

Delete the profile of the printer.

The procedure to delete the profile is as follows:

1. Select the profile to be deleted using the ▲/▼ buttons.
2. Press the ← button or press the right soft button to confirm.
The profile name is deleted from the list.

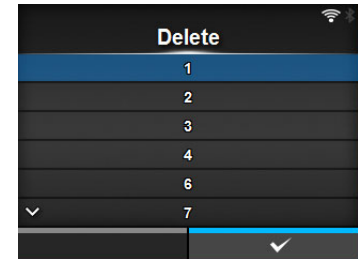

Load

Tools > Profiles > Load

Load the profile of the printer.

The procedure to load the profile is as follows:

1. Select the profile to be loaded using the ▲/▼ buttons.
2. Press the ← button or press the right soft button to confirm.
A checkmark shows on the right side of the loaded profile name. And the name of the loaded profile is shown on the **Profiles** menu in parenthesis.

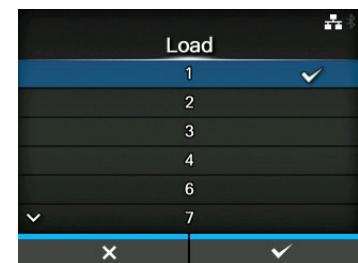

Save

Tools > Profiles > Save

Save the current printer configurations as a new profile.

The screen shows a list of the profiles saved in the printer. If no profile is saved, the screen shows an empty list.

To save existing printer configurations as a new profile, press the left soft button and enter the name of the profile.

You can enter a maximum of thirty-two characters including alphabet (upper case and lower case), numbers and symbols.

Press the right soft button to confirm.

The new profile name is shown on the list and is loaded.

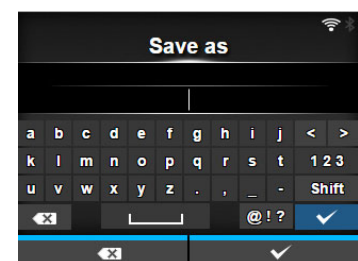
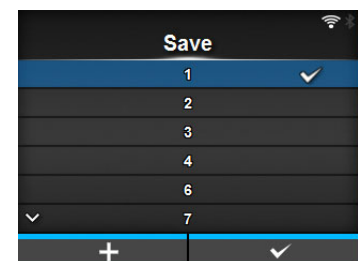

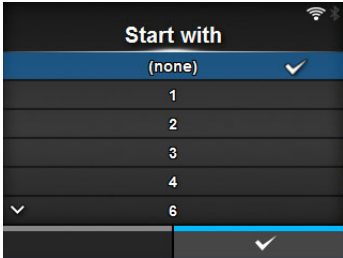
Start with	
<p><i>Tools > Profiles > Start with</i></p> <p>Select the profile to be loaded at printer startup. The procedure to load the profile at printer startup is as follows:</p> <ol style="list-style-type: none"> 1. Select the profile to be loaded at printer startup using the ▲/▼ buttons. 2. Press the ← button or press the right soft button to confirm. 	

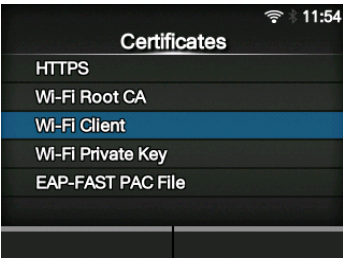
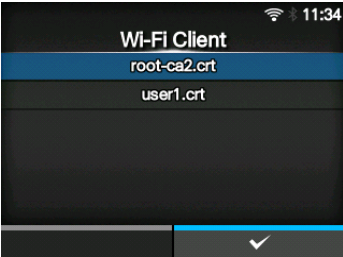
Certificates											
<p><i>Tools > Certificates</i></p> <p>Install certificates used for Wi-Fi authentication and for HTTPS. Available only if you have installed the USB memory. The setting items are as follows:</p>											
1	<table border="1" style="width: 100%; border-collapse: collapse;"> <tr> <td style="width: 20%; padding: 5px;">HTTPS</td> <td style="padding: 5px;">Installs the HTTPS certificates from the USB memory.</td> </tr> <tr> <td style="padding: 5px;">2</td> <td style="padding: 5px;">Wi-Fi Root CA Installs the Wi-Fi Root CA certificates from the USB memory.</td> </tr> <tr> <td style="padding: 5px;">3</td> <td style="padding: 5px;">Wi-Fi Client Installs the Wi-Fi client certificates from the USB memory.</td> </tr> <tr> <td style="padding: 5px;">4</td> <td style="padding: 5px;">Wi-Fi Private Key Installs the Wi-Fi private key from the USB memory.</td> </tr> <tr> <td style="padding: 5px;">5</td> <td style="padding: 5px;">EAP-FAST PAC File Installs the EAP-FAST PAC file from the USB memory.</td> </tr> </table>	HTTPS	Installs the HTTPS certificates from the USB memory.	2	Wi-Fi Root CA Installs the Wi-Fi Root CA certificates from the USB memory.	3	Wi-Fi Client Installs the Wi-Fi client certificates from the USB memory.	4	Wi-Fi Private Key Installs the Wi-Fi private key from the USB memory.	5	EAP-FAST PAC File Installs the EAP-FAST PAC file from the USB memory.
HTTPS	Installs the HTTPS certificates from the USB memory.										
2	Wi-Fi Root CA Installs the Wi-Fi Root CA certificates from the USB memory.										
3	Wi-Fi Client Installs the Wi-Fi client certificates from the USB memory.										
4	Wi-Fi Private Key Installs the Wi-Fi private key from the USB memory.										
5	EAP-FAST PAC File Installs the EAP-FAST PAC file from the USB memory.										
<p>The procedure to install the certificates and PAC files is as follows:</p> <ol style="list-style-type: none"> 1. Save the certificate files to the USB thumb drive memory's root folder. Acceptable file extensions are: .pem, .crt, .cer, .der for Root CA and client certificate in PEM or DER format. .pfx and .p12 for client certificates in PKCS #12 format. .prv and .key for private keys in PEM/PKCS#8 format. .pac for PAC files. 2. Insert the USB thumb drive memory into the USB connector (Type A). 3. Go to the Settings > Tools > Certificates menu. 4. Select the certificate you want to install. Refer to the table above. 5. Select the certificate file from the list. 											
<p>CAUTION Be sure to perform a virus check for the USB memory before connecting it to the printer. SATO Corporation shall not be held responsible for any printer malfunctions caused by a virus spread via USB memory.</p>											
<div style="display: flex; justify-content: space-between;"> <div style="width: 60%;"></div> <div style="width: 35%; text-align: center;">  </div> </div> <div style="display: flex; justify-content: space-between; margin-top: 10px;"> <div style="width: 60%;"></div> <div style="width: 35%; text-align: center;">  </div> </div>											

Barcode Checker

Tools > Barcode Checker

Set the barcode check function.

By connecting a barcode checker to the printer, you can verify the barcodes after printing.

Refer to [Section 7.6 Optional Barcode Check Function Configuration](#) for details on the barcode check function.

The setting items are as follows:

1	Test	Set up the barcode checker. *Available only if you have connected the barcode checker.
2	Settings	Set the barcode check function.

Note

- This function cannot be used in the following conditions:
 - When the print mode is tear-off mode
 - When you are using CL4NX RFID models
 - When the printer is in AEP mode
- Use the optional barcode checker stand kit to mount the barcode checker to the printer. For details, refer to the Barcode Checker Stand Kit Installation Manual that came with the barcode checker stand kit.

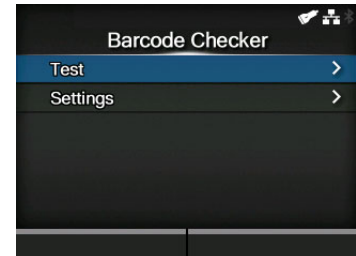

Test

Tools > Barcode Checker > Test

Set up the barcode checker.

Available only if you have connected the barcode checker.

The setting items are as follows:

1	Reader Name	Shows the barcode checker connected to the printer.
2	Reading Test	Perform a test read with the connected barcode checker.

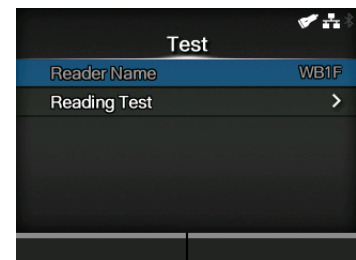

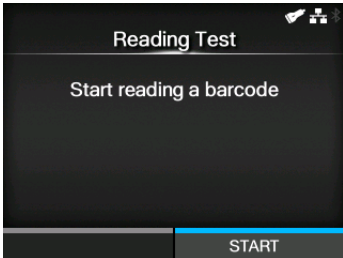
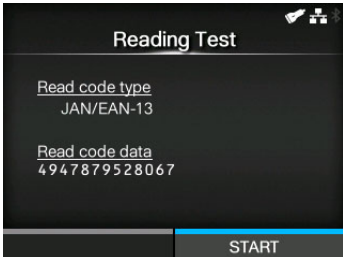
Reading Test	
<p><i>Tools > Barcode Checker > Test > Reading Test</i></p> <p>Perform a test read with the connected barcode checker. Available only if you have connected the barcode checker. Set a label with barcodes within the scanning range of the barcode checker, and then press the right soft button to start reading.</p> <p>If reading is successful, the code type and read data are displayed. The data is displayed only up to 23 bytes from the beginning.</p> <p>If the reading is unsuccessful, or if the displayed read result is not correct, adjust the position of the barcode checker by operating the barcode checker stand. For details on how to use the barcode checker stand, refer to the Barcode Checker Stand Kit Installation Manual that came with the barcode checker stand kit.</p>	 

Settings		
<p><i>Tools > Barcode Checker > Settings</i></p> <p>Set the barcode check function. The setting items are as follows:</p>		
1	Mode	Select the check mode or disable the barcode check function.
2	Start Position	Adjust the position at which the barcode check starts (position of the barcode checker at which reading starts).
3	VOID Print	Set whether to print error marks on the media when a barcode reading error or barcode comparison error occurs.
4	Retry Count	Set how many times the printer will try to print and check the same barcode after VOID printing when a barcode reading error or barcode comparison error occurs. *Shows only if you have selected Enabled in the VOID Print menu.
5	Host Notification	Set whether to return the barcode check results to the host from which the print data is sent.
6	Logs	Manage the barcode check log file saved in the printer.

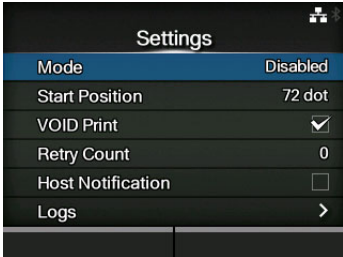

Mode

Tools > Barcode Checker > Settings > Mode

Select the check mode or disable the barcode check function.

The options are as follows:

- **Disabled:** Disable the barcode check function.
- **Readable:** Check if the printed barcodes are readable.
- **Comparison:** Check if the read results of the printed barcodes match the barcode data in the print data.

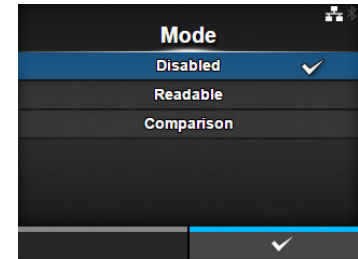

Start Position

Tools > Barcode Checker > Settings > Start Position

Adjust the position at which the barcode check starts (position of the barcode checker at which reading starts).

The barcode checker starts reading each media after the specified length passes from the printing start position.

This setting can be used to exclude first barcode(s) from the check target when multiple barcodes are printed on each media.

The setting range varies depending on the print resolution of the printer.

The setting range is as follows:

<CL4NX>

- 203 dpi: 10 to 20000 dots
- 305 dpi: 15 to 18000 dots
- 609 dpi: 30 to 9600 dots

<CL6NX>

- 203 dpi: 10 to 20000 dots
- 305 dpi: 15 to 18000 dots

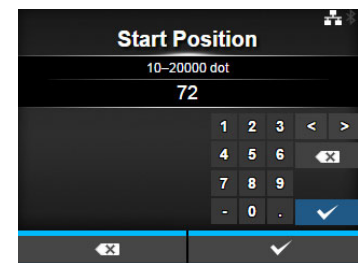

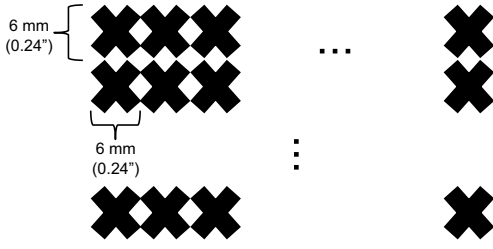
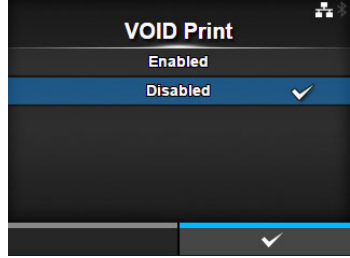
VOID Print	
<p><i>Tools > Barcode Checker > Settings > VOID Print</i></p> <p>Set whether to print error marks on the media when a barcode reading error or barcode comparison error occurs.</p> <p>6 x 6 mm (0.24" x 0.24") error marks are printed within the width of the print data image and in a length of up to 30 mm (1.18") from the trailing end of the label. The length varies depending on the image length of the print data and the operation mode.</p>  <p>The options are as follows:</p> <ul style="list-style-type: none"> • Enabled: If a reading error or comparison error occurs, the printer prints error marks on the label without pausing. After VOID printing, the printer prints and checks the same label until it reaches the number of retries specified in Retries. If the error still occurs after the specified number of retries are done, the printer pauses after VOID printing, and shows an error message on the display. • Disabled: If a reading error or comparison error occurs, the printer pauses and shows an error message on the display. <hr/> <p>Note Printing of the VOID mark is not supported in dispenser and linerless (CL4NX only) modes.</p>	

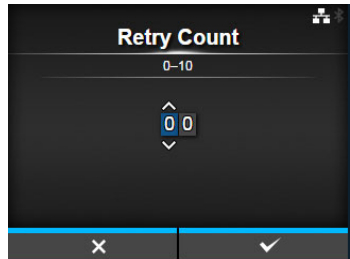
Retry Count	
<p><i>Tools > Barcode Checker > Settings > Retry Count</i></p> <p>Set how many times the printer will try to print and check the same barcode after VOID printing when a barcode reading error or barcode comparison error occurs.</p> <p>Shows only if you have selected Enabled in the VOID Print menu.</p> <p>The setting range is from 0 to 10.</p> <p>As long as the error continues to occur, the label is reprinted up to the number of times specified in this setting.</p> <p>For example, if you set it to 0, if the error occurs while checking the first label, the printer pauses and shows an error message after VOID printing. If set to 5, if the error continues to occur until the 6th label, the printer pauses after VOID printing for the 6th label, and shows an error message.</p>	

Host Notification

Tools > Barcode Checker > Settings > Host Notification

Set whether to return the barcode check results to the host from which the print data is sent.

The options are as follows:

- **Enabled:** Return the barcode check result of each label to the host as follows:
 - When the check is successful: <STX>BV, OK<ETX>
 - When the check is unsuccessful: <STX>BV, NG<ETX>
- **Disabled:** Do not return the barcode check results to the host.

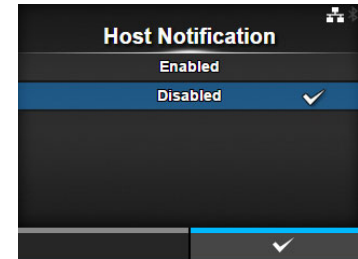

Logs

Tools > Barcode Checker > Settings > Logs

Manage the barcode check logs saved in the printer.

Available only if there are barcode check logs in the printer.

Note that new logs are overwritten on older logs when the log file reaches its maximum size (1MByte).

The setting items are as follows:

1	Copy	Copy the barcode check log file to the USB memory. *Available only if you have installed the USB memory.
2	Remove	Remove the barcode check logs.

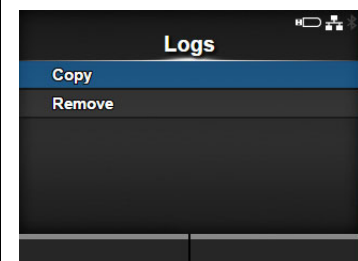

The barcode check log data is created in the following format:

```
YYYY/MM/DD hh:mm:ss (ZZZ) [TTTTTTTT] READING[IR]:SRSR:drdr...<CR><LF>
[RRRRRRR] COMMAND[IC]:SCSC:dcdc...<CR><LF>
```

Format ID	Description
YYYY	The date when the barcode check was performed. YYYY: year MM: month DD: day hh: hour mm: minute ss: second ZZZ: time zone * If the optional RTC kit is not installed, the system time will be output.
MM	
DD	
hh	
mm	
ss	
ZZZ	
TTTTTT	The total number of printed labels after the printer is powered on. *When the total number of printed labels becomes greater than an 8-digit number, the output digit will increase.
IR	The number of read data received after reaching the position at which the check starts. *When the check result is "IGNORED", this shows "00".
SRSR	Size of read data (bytes)
drdr...	Read data

Logs	
RRRRRRR	Check result
	SUCCESS <ul style="list-style-type: none"> • In readable mode, this means everything is correct. • In comparison mode, this means that the read data and print data match.
	FAILURE <ul style="list-style-type: none"> • In readable mode, this means that the barcode checker could not read the number of printed barcode data. • In comparison mode, this means that the read data and print data do not match.
	IGNORED <p>This means that the data is read during a period other than from the start to the end of checking, while the printer is active.</p>
IC	The amount of print data as a check target * If the check result is "IGNORED", this becomes "--".
SCSC	Size of print data (bytes) *If the check result is "IGNORED", this becomes "----".
dcdc...	Print data *If the check result is "IGNORED", nothing is output.

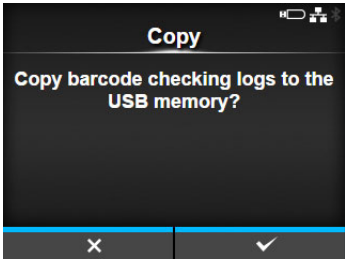
Copy	
<p><i>Tools > Barcode Checker > Settings > Logs > Copy</i></p> <p>Copy the barcode check log file to the USB memory. Available only if there are barcode check logs in the printer and if you have installed the USB memory. Press the right soft button to copy the log file to the USB memory.</p> <hr/> <p>CAUTION Be sure to perform a virus check for the USB memory before connecting it to the printer. SATO Corporation shall not be held responsible for any printer malfunctions caused by a virus spread via USB memory.</p>	

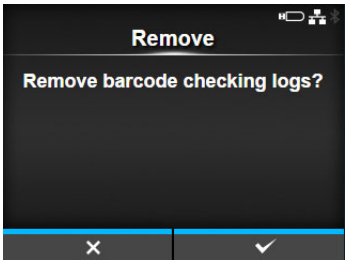
Remove	
<p><i>Tools > Barcode Checker > Settings > Logs > Remove</i></p> <p>Delete the barcode check log file. Available only if there are barcode check logs in the printer and if you have installed the USB memory. Press the right soft button to delete the log file.</p>	

Clone

Tools > Clone

Copy the current printer settings and installed data to the USB memory. Available only if you have installed the USB memory.

Use the clone configuration when the printer will be replaced with a new printer, or when you set up multiple printers with same settings.

The options are as follows:

- **Excl. LAN/Wi-Fi/IP:** Copy the printer settings and data, excluding network information, to the USB memory. This is useful when you set up multiple printers already configured for network with the same printer settings.
- **Incl. LAN/Wi-Fi:** Copy the printer settings and data, including network information (excluding the IP address), to the USB memory. This is useful when you set up multiple printers to be connected to the same network with the same printer settings.
- **Incl. LAN/Wi-Fi/IP:** Copy the printer settings and data, including network information (with the IP address), to the USB memory. This is useful when carrying over the settings of the printer to be replaced to a new printer.

CAUTION

Be sure to perform a virus check for the USB memory before connecting it to the printer. SATO Corporation shall not be held responsible for any printer malfunctions caused by a virus spread via USB memory.

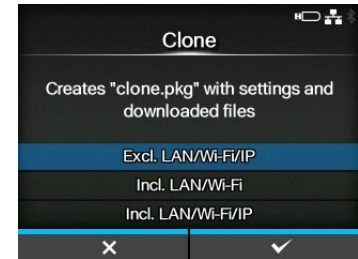

Startup Guide

Tools > Startup Guide

Enable or disable the startup guide.

The options are as follows:

- **Enabled:** Enable the startup guide.
- **Disabled:** Disable the startup guide.

If you have selected **Enabled** in the **Startup Guide** menu, the startup guide shows the next time you power on the printer.

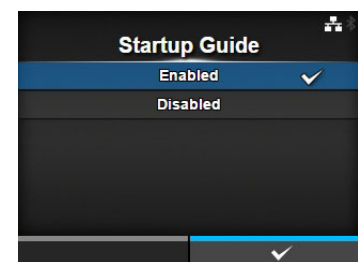

4.4.7 Information Menu

In the **Information** menu, there are setting items as follows:

Information		
1	Help	Shows the guidance video.
2	Build Version	Shows the firmware version.
3	Applications	Shows various application versions.
4	Installation Log	Shows the installation log data. *Shows only if there is a log data in the printer.
5	Print Module	Shows the print module information.
6	Counters	Shows the counter information.
7	IPv4 Address	Shows the IPv4 address.
8	IPv6 Address	Shows the IPv6 address. *Does not show when Wi-Fi Direct is active.
9	LAN MAC	Shows the MAC address of the LAN. *Shows only if the LAN interface is selected.
10	Wi-Fi MAC	Shows the MAC address of the wireless LAN. *Shows only if the optional wireless LAN is installed and the Wi-Fi interface is selected.
11	Wi-Fi Region	Shows the region information of the wireless LAN. *Shows only if the optional wireless LAN is installed and the Wi-Fi interface is selected.
12	Wi-Fi Status	Shows the status of the wireless LAN. *Shows only if the optional wireless LAN is installed and the Wi-Fi interface is selected.
13	Wi-Fi Direct	Shows the connection information of Wi-Fi Direct. *Shows only if connected using Wi-Fi Direct.
14	Wi-Fi Versions	Shows the version of the wireless LAN. *Shows only if the optional wireless LAN is installed and the Wi-Fi interface is selected.

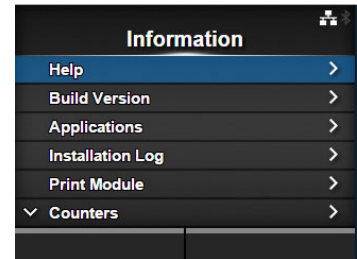

Help		
<p><i>Information > Help</i></p> <p>Shows the guidance video.</p> <p>You can view the video for loading the media and ribbon, the cleaning method and replacement method of consumables. For the video list and playback method, refer to Section 4.1.4 Guidance Video. The list of videos are as follows:</p>		
1	Install Paper	Shows the video for loading the media.
2	Install Ribbon	Shows the video for loading the ribbon.
3	Replace Paper	Shows the video for replacing the media.
4	Replace Ribbon	Shows the video for replacing the ribbon.
5	Replace Head	Shows the video for replacing the print head.
6	Replace Platen	Shows the video for replacing the platen roller.
7	Cleaning	Shows the video of the cleaning method.

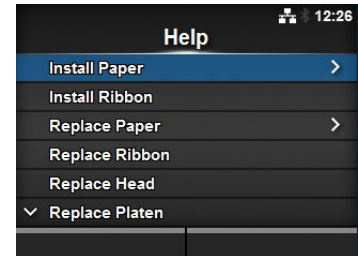

Install Paper		
<p><i>Information > Help > Install Paper</i></p> <p>Shows the video for loading the media. The setting items are as follows:</p>		
1	Roll	Shows the video for loading the media roll.
2	Fanfold	Shows the video for loading the fan-fold media.

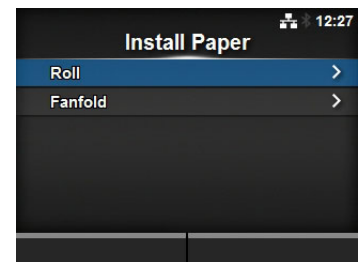

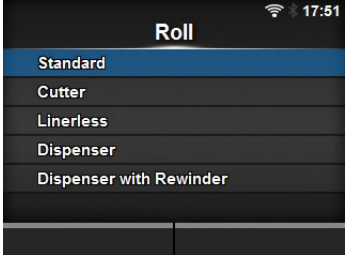
Roll			
<p><i>Information > Help > Install Paper > Roll</i></p> <p>Shows the video for loading the media roll. The setting items are as follows:</p>			
1	Standard		Shows the video for loading the media roll to a standard printer.
2	Cutter		Shows the video for loading the media roll to a printer installed with a cutter.
3	Linerless (CL4NX only)		Shows the video for loading the media roll to a printer installed with a linerless cutter kit.
4	Dispenser		Shows the video for loading the media roll to a printer installed with a dispenser.
5	Dispenser with Rewinder		Shows the video for loading the media roll to a printer installed with a dispenser and liner rewinder.

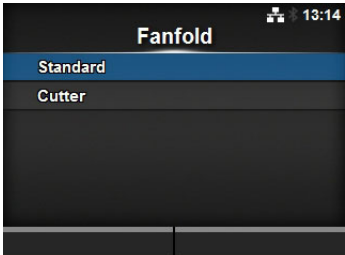
Fanfold			
<p><i>Information > Help > Install Paper > Fanfold</i></p> <p>Shows the video for loading the fan-fold media. The setting items are as follows:</p>			
1	Standard		Shows the video for loading the fan-fold media to a standard printer.
2	Cutter		Shows the video for loading the fan-fold media to a printer installed with a cutter.

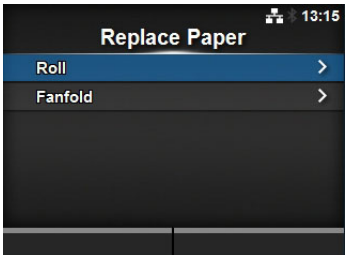
Replace Paper			
<p><i>Information > Help > Replace Paper</i></p> <p>Shows the video for replacing the media. The setting items are as follows:</p>			
1	Roll		Shows the video for replacing the media roll.
2	Fanfold		Shows the video for replacing the fan-fold media.

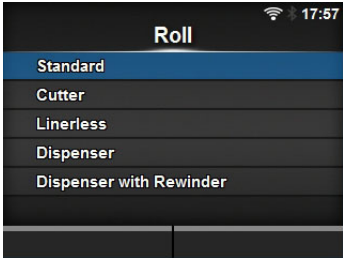
Roll			
<i>Information > Help > Replace Paper > Roll</i>			
Shows the video for replacing the media roll. The setting items are as follows:			
1	Standard		Shows the video for replacing the media roll in a standard printer.
2	Cutter		Shows the video for replacing the media roll in a printer installed with a cutter.
3	Linerless (CL4NX only)		Shows the video for replacing the media roll in a printer installed with a linerless cutter kit.
4	Dispenser		Shows the video for replacing the media roll in a printer installed with a dispenser.
5	Dispenser with Rewinder		Shows the video for replacing the media roll in a printer installed with a dispenser and liner rewinder.

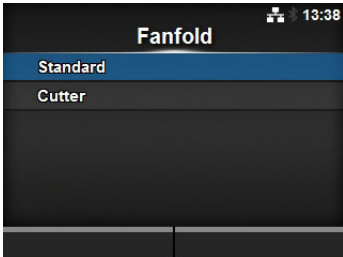
Fanfold			
<i>Information > Help > Replace Paper > Fanfold</i>			
Shows the video for replacement of fan-fold media. The setting items are as follows:			
1	Standard		Shows the video for replacing the fan-fold media in a standard printer.
2	Cutter		Shows the video for replacing the fan-fold media in a printer installed with a cutter.

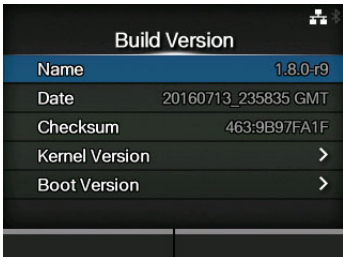
Build Version			
<i>Information > Build Version</i>			
Shows the information and version of this printer.			
1	Name		Shows the name of the build version.
2	Date		Shows the build date.
3	Checksum		Shows the checksum of the build version.
4	Kernel Version		Shows the kernel version.
5	Boot Version		Shows the boot version.

Kernel Version	
<p><i>Information > Build Version > Kernel Version</i></p> <p>Shows the kernel version of this printer.</p>	

Boot Version							
<p><i>Information > Build Version > Boot Version</i></p> <p>Shows the boot version of this printer. The setting items are as follows:</p>							
1	<table border="1" style="width: 100%; border-collapse: collapse;"> <tr> <td style="width: 20%; padding: 2px;">Disks</td> <td style="padding: 2px;">Shows the Disks.</td> </tr> <tr> <td style="padding: 2px;">Warp!!-mode</td> <td style="padding: 2px;">A checked box shows enabled while an unchecked box shows disabled.</td> </tr> <tr> <td style="padding: 2px;">Date</td> <td style="padding: 2px;">Shows the build date of the boot version.</td> </tr> </table>	Disks	Shows the Disks.	Warp!!-mode	A checked box shows enabled while an unchecked box shows disabled.	Date	Shows the build date of the boot version.
Disks	Shows the Disks.						
Warp!!-mode	A checked box shows enabled while an unchecked box shows disabled.						
Date	Shows the build date of the boot version.						

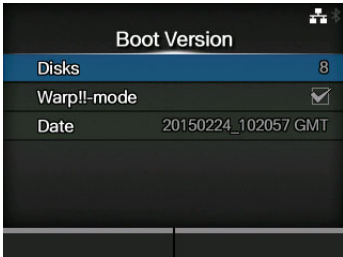

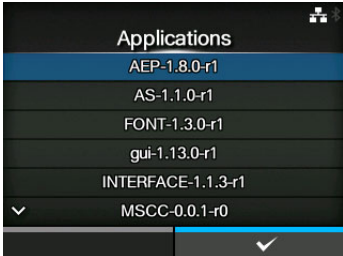
Applications	
<p><i>Information > Applications</i></p> <p>Shows the versions of the installed applications in the printer, such as printer languages.</p>	

Installation Log		
<p><i>Information > Installation Log</i></p> <p>Show or clear the installation log data in this printer. The setting items are as follows:</p>		
1	RPM Log	Shows the RPM log data.
2	System Restore	Shows the system restore log data.
<p>Press the right soft button (CLEAR) to clear the selected log data.</p> <hr/> <p>Note This screen is not shown if there is no log data in the printer.</p>		

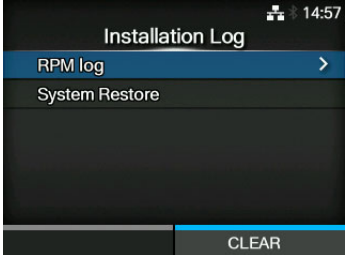

RPM Log	
<p><i>Information > Installation Log > RPM Log</i></p> <p>Shows a list of RPM log files containing three sections: installed, updated and obsolete. The RPM log file is created after installing a pkg-file containing rpm-files.</p>	



System Restore	
<p><i>Information > Installation Log > System Restore</i></p> <p>Shows the system restore log.</p> <p>The system restore log file is created after installing a pkg-file that incurs the inability to operate the printer LCD.</p>	

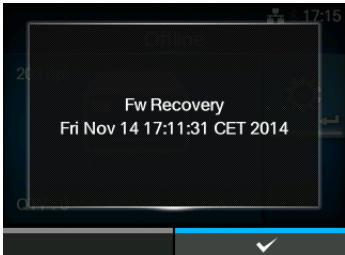

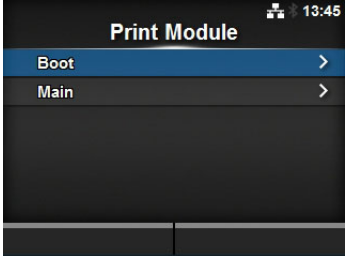
Print Module			
<p><i>Information > Print Module</i></p> <p>Shows the information about the print module of this printer. The setting items are as follows:</p>			
1	Boot	Shows the Boot firmware version.	
2	Main	Shows the Main firmware version.	

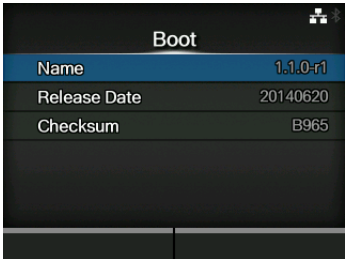
Boot			
<p><i>Information > Print Module > Boot</i></p>			
1	Name	Shows the Boot firmware version.	
2	Release Date	Shows the Boot firmware release date.	
3	Checksum	Shows the Boot firmware checksum.	

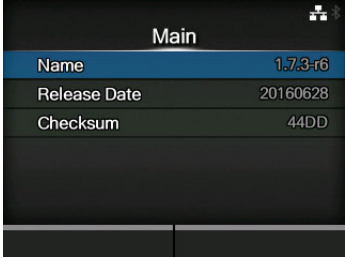
Main			
<p><i>Information > Print Module > Main</i></p>			
1	Name	Shows the Main firmware version.	
2	Release Date	Shows the Main firmware release date.	
3	Checksum	Shows the Main firmware checksum.	

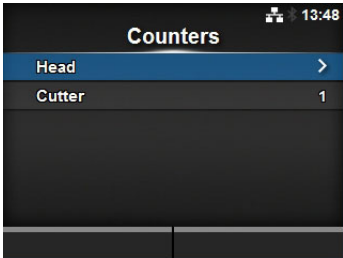
Counters		
<i>Information > Counters</i>		
Shows the counter information of this printer. The setting items are as follows:		
1	Head	Shows the head counter information of this printer.
2	Cutter	Shows the current number of cuts.
<p>CAUTION Only SATO authorized service personnel are permitted to clear the counter.</p>		
		

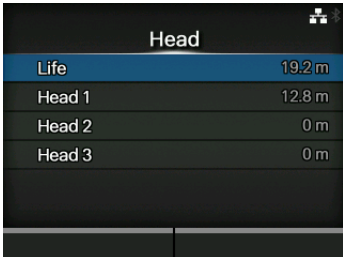
Head		
<i>Information > Counters > Head</i>		
Shows the head counter information of this printer.		
1	Life	Shows the current print distance.
2	Head 1	Head 1 shows the current print distance. When you replace the print head and the counter is cleared, the value of Head 2 is shown in Head 3 and the value of Head 1 is shown in Head 2. Head 1 will start to count from 0 again.
3	Head 2	
4	Head 3	
		

IPv4 Address	
<i>Information > IPv4 Address</i>	
Shows the IPv4 address.	
	

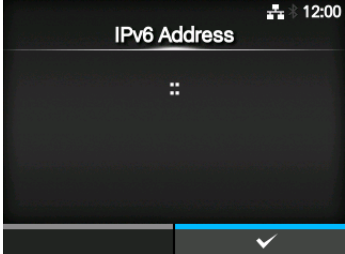
IPv6 Address	
<p><i>Information > IPv6 Address</i></p> <p>Shows the IPv6 address.</p> <hr/> <p>Note When Wi-Fi Direct is active, this IPv6 address screen is not shown.</p> <hr/>	

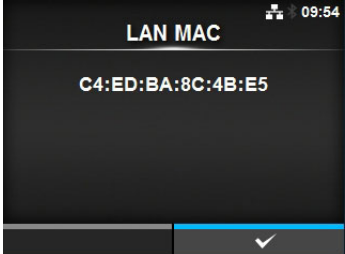
LAN MAC	
<p><i>Information > LAN MAC</i></p> <p>Shows the MAC address of the LAN. Shows only if LAN is the active interface.</p>	

Wi-Fi MAC	
<p><i>Information > Wi-Fi MAC</i></p> <p>Shows the MAC address of the wireless LAN. Shows only if you have installed the optional wireless LAN and Wi-Fi is the active interface.</p>	

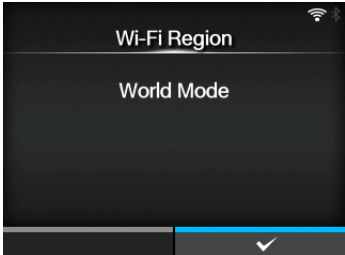
Wi-Fi Region	
<p><i>Information > Wi-Fi Region</i></p> <p>Shows the region information of the wireless LAN. Shows only if you have installed the optional wireless LAN and Wi-Fi is the active interface.</p>	

Wi-Fi Status

Information > Wi-Fi Status

Shows the status of the wireless LAN.
Shows only if you have installed the optional wireless LAN and Wi-Fi is the active interface.

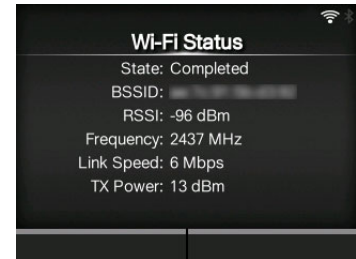

Wi-Fi Direct

Information > Wi-Fi Direct

Shows the connection information of Wi-Fi Direct.
Shows only if Wi-Fi Direct is the active interface and you are connected using Wi-Fi Direct.



Wi-Fi Versions

Information > Wi-Fi Versions

Shows the version of the wireless LAN.
Shows only if you have installed the optional wireless LAN.



4.5 Web Configuration

The printer can be operated through a web configuration page using any browser. With an Ethernet LAN or WLAN connection, users can remotely get information from the printer or perform the printer configuration.

You need the printer IP address to access the web configuration page. Refer to [Section 4.4.7 Information Menu](#) for the printer IP address.

If the printer IP address is 192.168.143.123, open up browser and enter the following URL: <https://192.168.143.123>

When a security certificate is prompted, you must acknowledge and click Continue.

The web configuration page will be shown as follows.

On the upper right of each page, the model name, current resolution and MAC address are shown.

4.5.1 Dashboard

The Dashboard, which consists of smaller sections, is the default page of WebConfig. Each section shows specific information or status of the printer.

You can view Dashboard and Certificates pages without logging in.

However, login is required to view Settings and Tools pages.

Printer Status shows the current state (online, offline error) and current status icons.

Printing shows the print speed, darkness, sensor, print mode and backfeed setting.

Device shows the model, current resolution and options that are installed.

The screenshot shows the SATO WebConfig dashboard with the following sections:

- Printer Status:** Shows the printer is Offline.
- Printing:** Shows Speed: 6 ips, Darkness Range: A, Darkness: 5, Sensor Type: Gap, Print Mode: Tear-Off, and Backfeed: Before.
- Device:** Shows Model: CL4NX, Resolution: 203 dpi (8 dpmm), and Installed Options: Bluetooth, Ext I/O, NFC, WLAN.
- Network:** Shows IPv4 Address and MAC Address: 00:80:92:50:9E:86.
- System:** Shows Firmware version: 1.8.0-r9, Uptime: 18min, and Contact information.
- Wi-Fi:** Shows Mode: infra, SSID, BSSID, and Channel: 1 (2412 MHz).
- Wi-Fi Strength:** A gauge showing -39 dBm.

Additional information from the top right of the dashboard:

- Model: SATO CL4NX
- Resolution: 203 dpi (8 dpmm)
- MAC Address: 00:80:92:50:9E:86

Network shows the current IP address and MAC address of the active interface.

System shows the current firmware version, uptime, SNMP contact, name and location.

This information are shown only if Wi-Fi is available and active. Wi-Fi Strength is not shown if the printer is P2P GO.

4.5.2 Settings

Login is required to view this page. Click Login and then enter the correct password to log in. The default password for the username *settings* is *0310*.



After logging in, the following page will be shown:



These six setting items are also available on the printer through the LCD screens. For details, refer to [Section 4.4 Details of the Settings Menu Screen](#).

Click on any icon on this Settings page to perform the settings.

The following page will be shown after clicking on Printing:

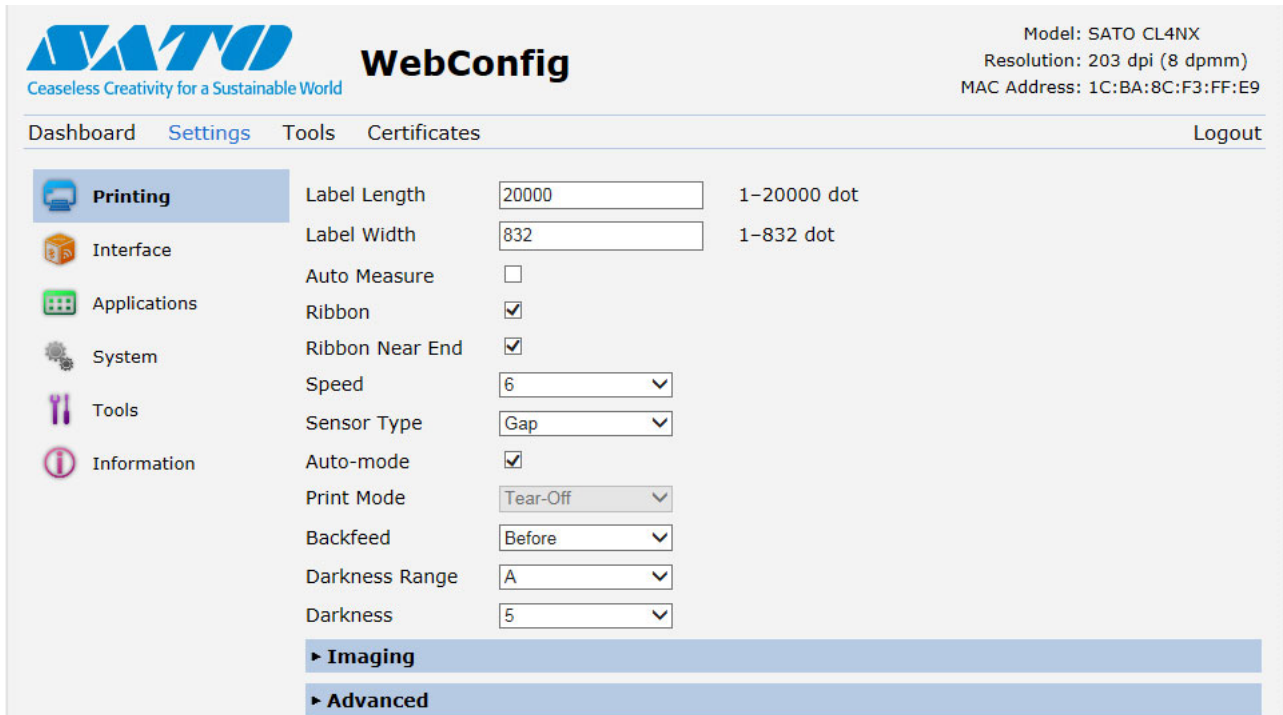

Printing

Refer to [Section 4.4.2 Printing Menu](#).

Interface

Refer to [Section 4.4.3 Interface Menu](#).

Applications

Refer to [Section 4.4.4 Applications Menu](#).

System

Refer to [Section 4.4.5 System Menu](#).

Tools

Refer to [Section 4.4.6 Tools Menu](#).

Information

Refer to [Section 4.4.7 Information Menu](#).

4.5.3 Tools

Login is required to view this page. Click Login and then enter the correct password to log in as in [Section 4.5.2 Settings](#).

The default password for the username *settings* is *0310*.

After logging in, the following page will be shown:

The screenshot displays the SATO WebConfig interface. At the top left is the SATO logo with the tagline "Ceaseless Creativity for a Sustainable World". The main title is "WebConfig". On the top right, system information is shown: "Model: SATO CL4NX", "Resolution: 203 dpi (8 dpmm)", and "MAC Address: 1C:BA:8C:F3:FF:E9". A navigation bar includes "Dashboard", "Settings", "Tools" (which is highlighted), and "Certificates". A "Logout" link is also present. On the left side, a vertical menu lists several tools: "Upload" (highlighted), "Clone", "Install Package", "Logs", "Reset", "Passwords", "Test Print", "Support Info", and "Reboot". The main content area shows five sections for uploading files: "HTTPS Certificate", "Wi-Fi Root CA", "Wi-Fi Client Certificate", "Wi-Fi Private Key", and "Wi-Fi EAP-FAST PAC File". Each section contains a text input field, a "Browse..." button, and an "Upload" button.

Upload

Refer to [Certificates on page 230](#).

Clone

Refer to [Clone on page 237](#).

Install Package

Refer to **Section 2.5 Downloading Firmware** of the CL4NX/CL6NX service manual.

Logs

Lists all log files in the log directory. Users can click to download the file.

Reset

Refer to [Select on page 226](#).

Passwords

Refer to [Change Password on page 215](#).

Test Print

Refer to [Test Print on page 216](#).

Support Info

List various information of the printer such as attached options, serial number, application versions and settings configuration. You can also get a screenshot of the current printer display and an image of the last printout.

Reboot

Reboot the printer.

4.5.4 Certificates

Shows the Root Certificate authority and client certificates installed on the printer.

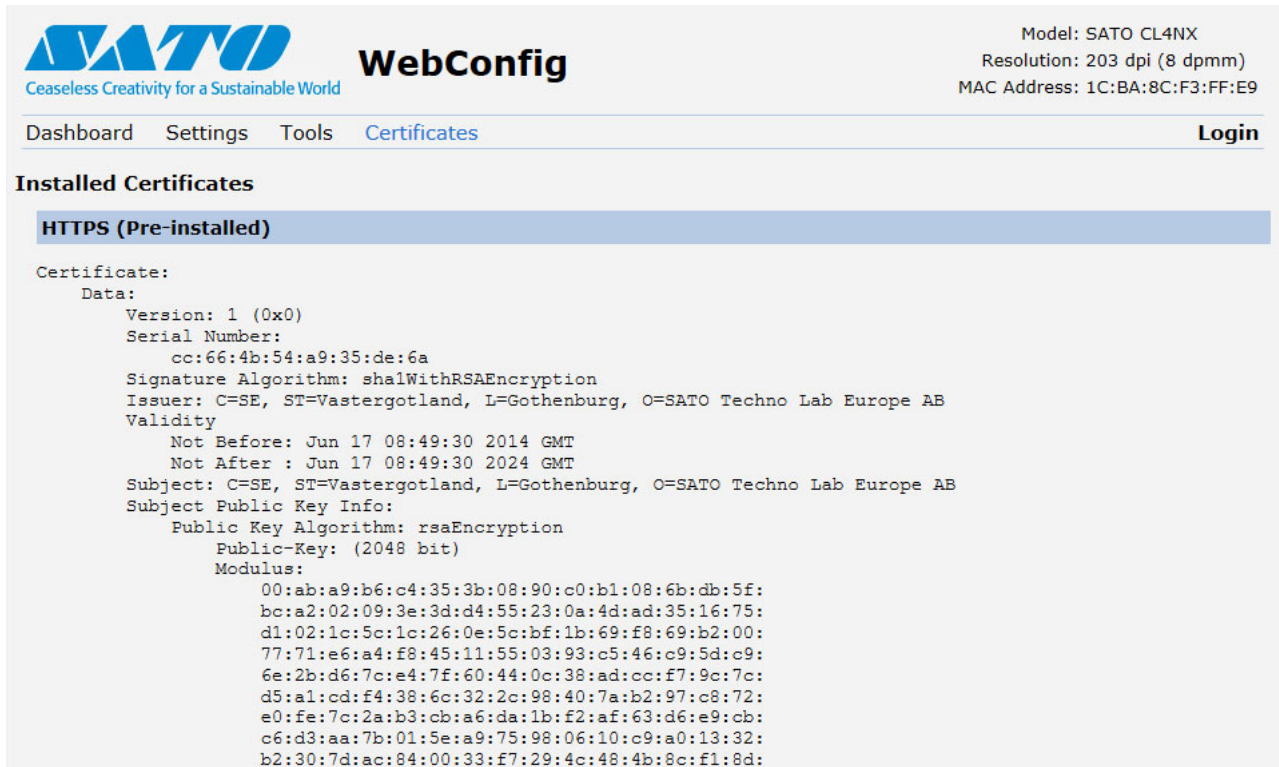

The screenshot shows the SATO WebConfig interface. At the top left is the SATO logo with the tagline "Ceaseless Creativity for a Sustainable World". To the right of the logo is the text "WebConfig". Further right, the printer's model "SATO CL4NX", resolution "203 dpi (8 dpmm)", and MAC address "1C:BA:8C:F3:FF:E9" are displayed. Below this is a navigation bar with "Dashboard", "Settings", "Tools", and "Certificates" (the active page), and a "Login" button on the far right. The main content area is titled "Installed Certificates" and features a blue header for "HTTPS (Pre-installed)". Underneath, the details of a certificate are listed in a structured format:

```

Certificate:
  Data:
    Version: 1 (0x0)
    Serial Number:
      cc:66:4b:54:a9:35:de:6a
    Signature Algorithm: sha1WithRSAEncryption
    Issuer: C=SE, ST=Vastergotland, L=Gothenburg, O=SATO Techno Lab Europe AB
    Validity
      Not Before: Jun 17 08:49:30 2014 GMT
      Not After : Jun 17 08:49:30 2024 GMT
    Subject: C=SE, ST=Vastergotland, L=Gothenburg, O=SATO Techno Lab Europe AB
    Subject Public Key Info:
      Public Key Algorithm: rsaEncryption
      Public-Key: (2048 bit)
      Modulus:
        00:ab:a9:b6:c4:35:3b:08:90:c0:b1:08:6b:db:5f:
        bc:a2:02:09:3e:3d:d4:55:23:0a:4d:ad:35:16:75:
        d1:02:1c:5c:1c:26:0e:5c:bf:1b:69:f8:69:b2:00:
        77:71:e6:a4:f8:45:11:55:03:93:c5:46:c9:5d:c9:
        6e:2b:d6:7c:e4:7f:60:44:0c:38:ad:cc:f7:9c:7c:
        d5:a1:cd:f4:38:6c:32:2c:98:40:7a:b2:97:c8:72:
        e0:fe:7c:2a:b3:cb:a6:da:1b:f2:af:63:d6:e9:cb:
        c6:d3:aa:7b:01:5e:a9:75:98:06:10:c9:a0:13:32:
        b2:30:7d:ac:84:00:33:f7:29:4c:48:4b:8c:f1:8d:
  
```

Note

The client certificate that is a PFX (PKCS #12) file will not be shown.

This page is intentionally left blank.

5

Cleaning and Performing Printer Adjustments

5.1 Maintenance

A dirty print head or platen roller not only affects the print quality but also causes errors. Use a cleaning kit or cleaning sheet to clean the printer regularly.

CAUTION

- Do not touch the power button, connect or disconnect the power cord while your hands are wet. Doing so could cause an electric shock.
- Disconnect the power cord from the AC outlet before you begin cleaning.
The print head and its surroundings are hot after printing. Wait until the printer cools down.
- Touching the edge of the print head with your bare hand could cause injury.
- Be careful not to touch the cutter blade when cleaning the printer.
- Use a cleaning pen, cotton swab or cotton cloth from a cleaning kit to clean. Do not clean with a hard object. Doing so could cause damage.
- Remove the media and ribbon before cleaning.

CAUTION for CL4NX only (if installed with linerless cutter kit)

- Open the print head if the printer is not used for printing for more than one day. Paper jam might occur the next time when you print if the print head is closed for a long period with linerless label loaded.
- When loading linerless label, make sure that the front end of the media extends about 3 cm (1.18") out the media discharge outlet.

Note

You can purchase a cleaning kit or cleaning sheet from a SATO reseller or technical service center.

5.2 Maintenance of the Print Head and Platen Roller

Maintenance should be performed at the following regular intervals:

- After you print one media roll or print media for one hundred and fifty meters.

Use the cleaning kit to clean these parts:

- Print head
- Platen roller
- Media sensors
- Media guide

- After you print six media rolls or print media for nine hundred meters.

Use the cleaning sheet to clean these parts:

- Print head
- Platen roller

Use the cleaning kit to clean these parts:

- Media route
- Ribbon route

Maintenance intervals for the optional linerless cutter kit (CL4NX only):

- After you print one media roll or whenever there is any glue residue or paper dust on the media route.

Use the cleaning kit to clean these parts:

- Print head
- Media guide
- Media sensors
- Guide rollers

* There is no need of cleaning the linerless platen roller unless it is significantly soiled.

Note

The above maintenance intervals are only for reference. Perform the cleaning when necessary.

5.2.1 Maintenance using the Cleaning Kit

The maintenance procedure using the cleaning kit is as follows:



CAUTION

Never use organic solvents, such as thinner and benzene to clean the printer.

Note

For details on the cleaning kit, refer to the manual attached to the cleaning kit.

1

Make sure that the printer is in power off mode, then disconnect the power cord from the AC outlet.

2 Open the top cover.

CAUTION

Open the top cover fully to prevent accidental drop of the cover.

3 Push the head lock lever ① towards the rear to unlock the print head.

CAUTION

- The print head and its surroundings are hot after printing. Be careful not to touch it, to avoid being burned.
- Touching the edge of the print head with your bare hand could cause injury.

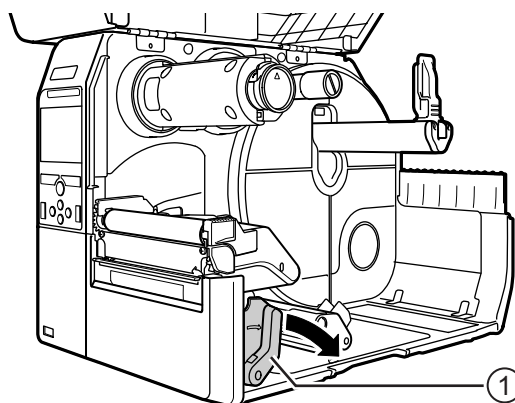

4 Remove the media and ribbon if they are already loaded.

Refer to [Section 3.3 Removing the Ribbon](#) and the reverse procedure in [Section 3.5 Loading Media](#).

5 Clean the dirt on the print head ②, platen roller ③ and ribbon roller ④ using a cleaning pen or a cotton swab dabbed with cleaning liquid.

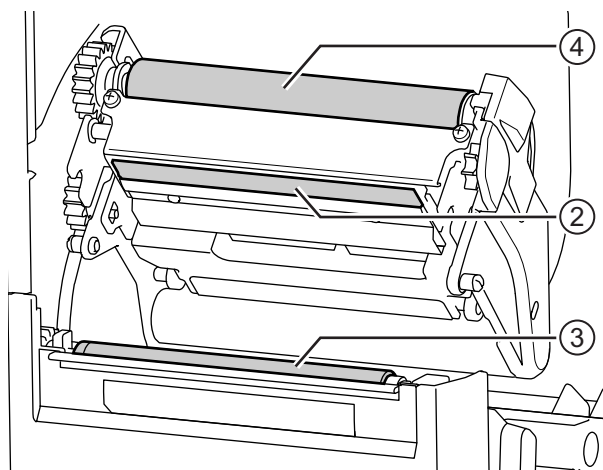

- 6** Tilt the **sensor guide lock** ⑤ down and pull out the **media sensor guide** ⑥.

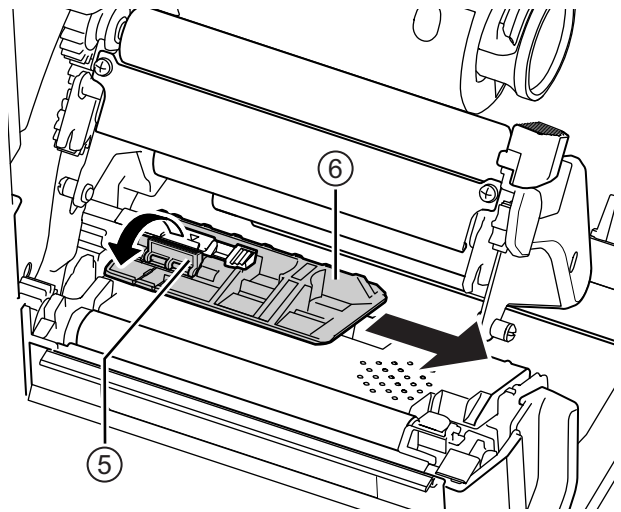

- 7** Clean the bottom of the **media sensor guide** using the cotton cloth dabbed with cleaning liquid.

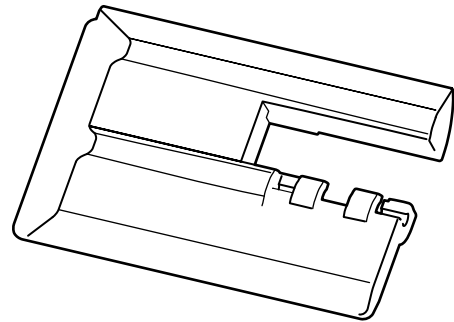

- 8** Clean the **media sensor** ⑦ using the cotton cloth dabbed with cleaning liquid.

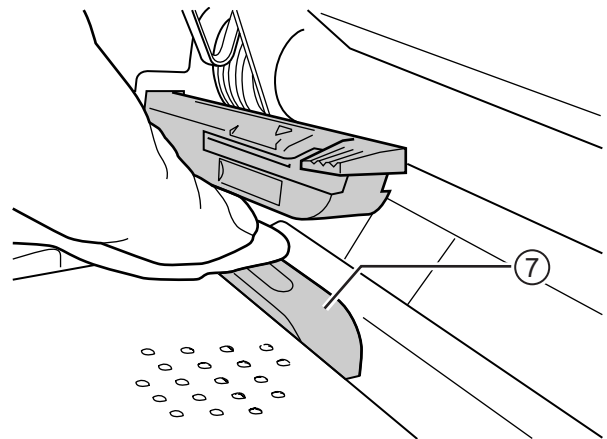

- 9** Return the **media sensor guide** to its original position and tilt the **sensor guide lock** up to the locked position.

5.2.2 Additional Procedure for the Optional Linerless Cutter Kit (CL4NX only)

- 1 After performing step 8 above, clean the **media guide** ⑧ and inner surface ⑨ that is in contact to the label edge. Use the cotton cloth dabbed with cleaning liquid to clean.

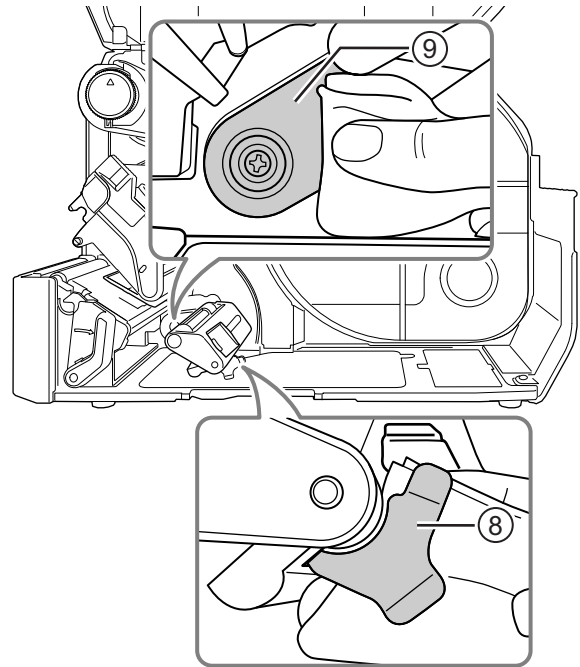

- 2 Clean the **guide rollers** ⑩ using the cotton cloth dabbed with cleaning liquid. Rotate the guide rollers to clean the whole areas of them.

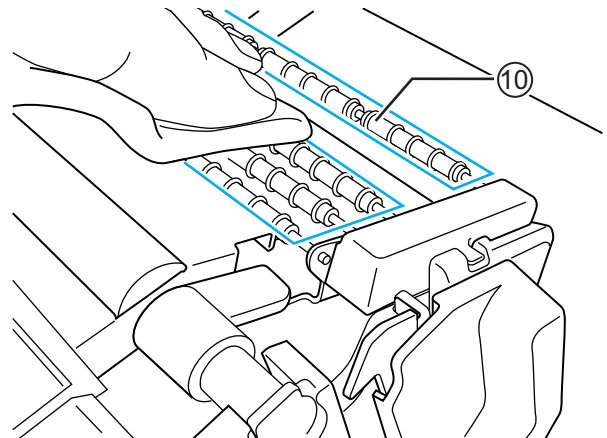

5.2.3 Maintenance using the Cleaning Sheet

The maintenance procedure using the cleaning sheet is as follows:

- 1** Make sure that the printer is in power off mode, then disconnect the power cord from the AC outlet.
- 2** Open the **top cover**.

CAUTION

Open the top cover fully to prevent accidental drop of the cover.

- 3** Push the **head lock lever** ① towards the rear to unlock the print head.

CAUTION

- The print head and its surroundings are hot after printing. Be careful not to touch it, to avoid being burned.
- Touching the edge of the print head with your bare hand could cause injury.

- 4** Remove the media and ribbon if they are already loaded.

Refer to [Section 3.3 Removing the Ribbon](#) and the reverse procedure in [Section 3.5 Loading Media](#).

- 5** Place the **cleaning sheet** ② between the **print head** and the **platen roller**.

Note

Align the rough side of the cleaning sheet adjacent to the print head.

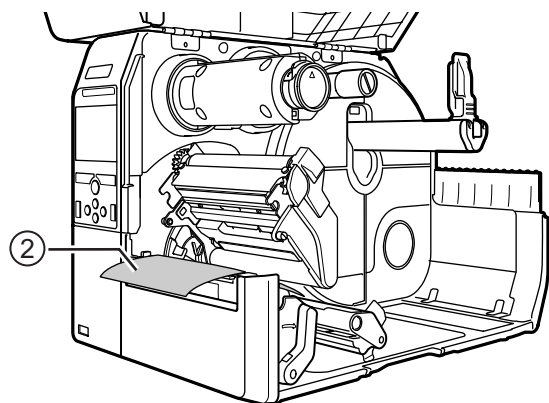
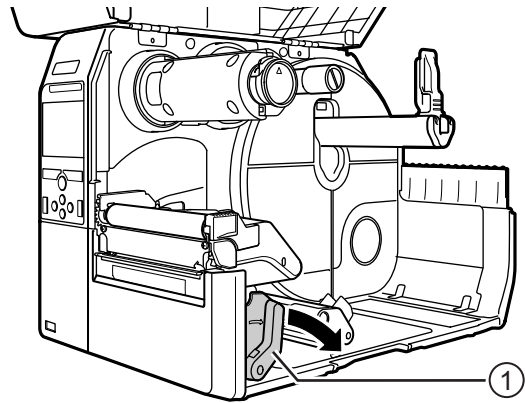

- 6** Press the **print head** down until you lock the **head lock lever** in place.

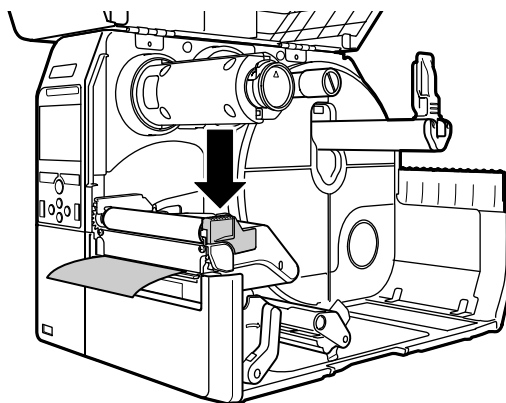

- 7** Using two hands, pull the **cleaning sheet** away from the printer.

- 8** After you pull out the cleaning sheet, repeat steps 5 through 7, two or three more times.

When no more dirt appears on the cleaning sheet after you have pulled it out, stop repeating these steps.

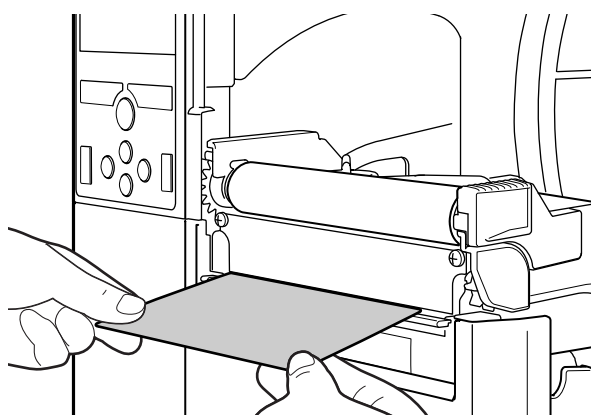

- 9** Push the **head lock lever** ① towards the rear to unlock the **print head**.

- 10** Use a **cleaning pen** ③ to clean the dirt on the **print head**.

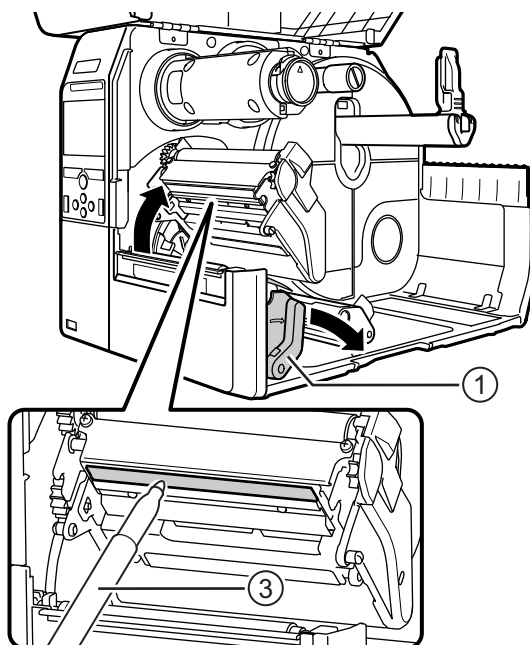

5.3 Adjusting the Base Reference Point

5.3.1 About the Base Reference Point

The base reference point is the point at which one determines the print position and stop/cut/dispensing position.

The base reference point differs depending on the operation mode or media sensor you use.

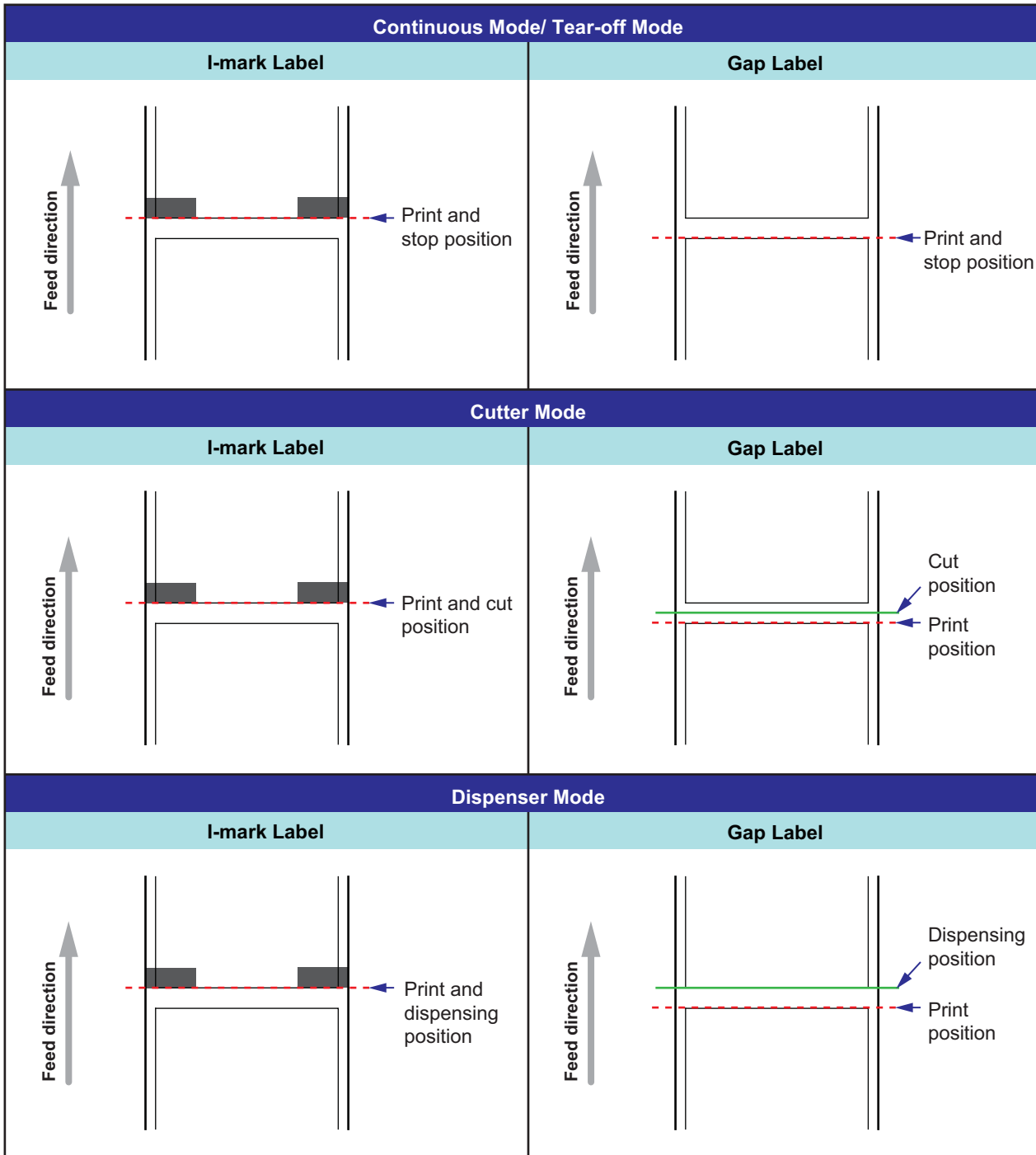

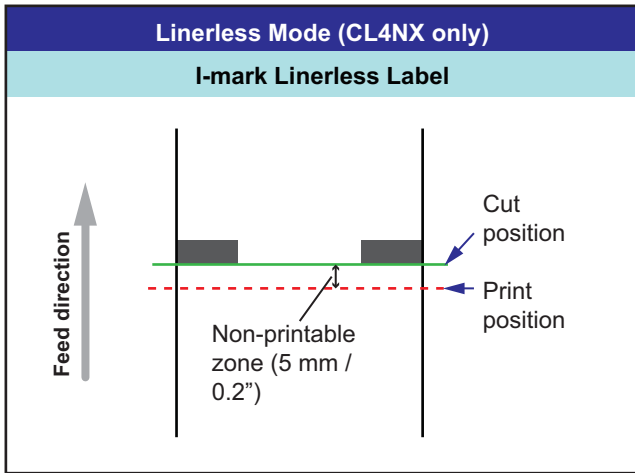

5.3.2 Adjusting the Print Position

Set the **Pitch** in the **Printing > Advanced > Adjustments** menu to adjust the print position.

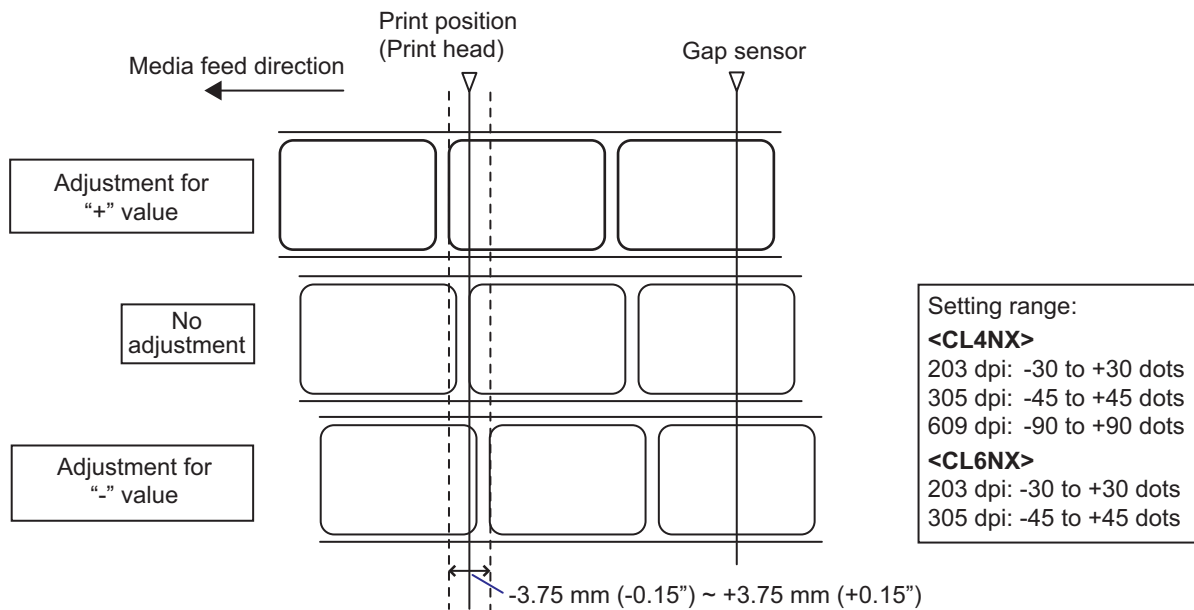

Note

The above base reference point (print position) will be the stop position when the sensor type is set to Gap sensor.

Adjust the print position using the following procedure:

- 1 When the printer is in online mode, press the **▶||** button on the operator panel to change to offline mode.
- 2 Press the **←** button to show the **Settings** menu.
- 3 Select **Printing** using the **◀/▶** buttons, then press the **←** button.
- 4 Select **Advanced > Adjustments > Pitch** using the **▲/▼** buttons, then press the **←** button.
The Pitch screen shows.
- 5 Change the setting value. Press the **◀/▶/▲/▼** buttons to select a number and then press the **←** button to enter the number to the text box.
The setting range is as follows:

<CL4NX>	
203 dpi:	-30 to +30 dots
305 dpi:	-45 to +45 dots
609 dpi:	-90 to +90 dots
<CL6NX>	
203 dpi:	-30 to +30 dots
305 dpi:	-45 to +45 dots
- 6 Press the right soft button to save the setting value.
- 7 Press the **▶||** button to change to offline mode.
- 8 Press the **▶||** button again to change to online mode.
You can perform printing to check the adjusted print position.

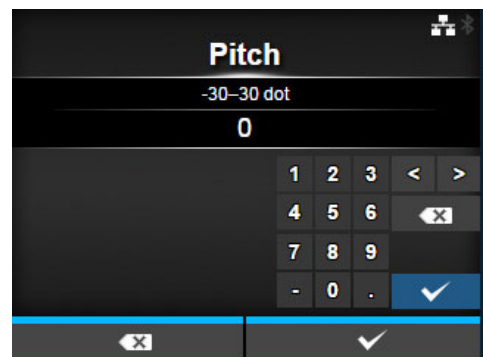
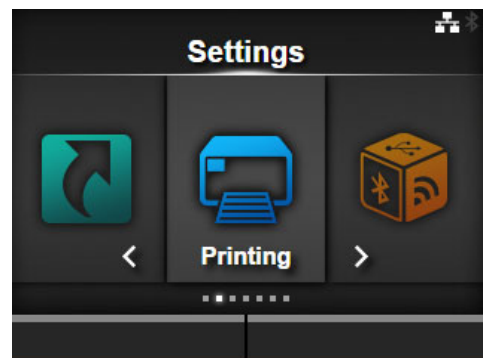

5.3.3 Adjusting the Media Stop Position

Set the **Offset** in the **Printing > Advanced > Adjustments** menu to adjust the media stop position.

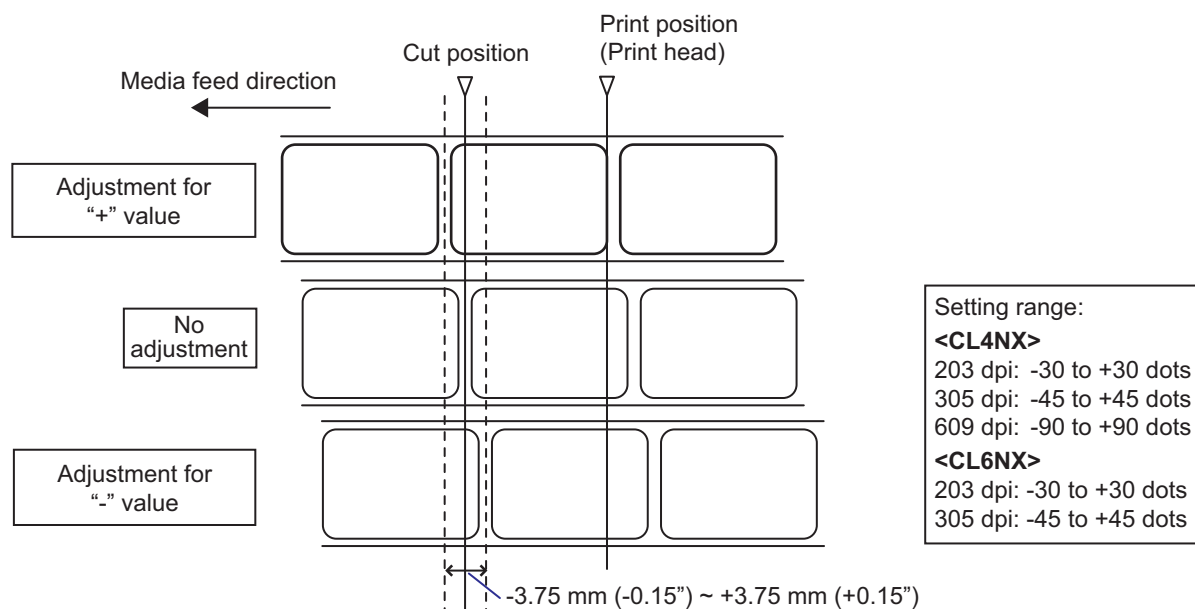

Note

- The above cut reference position for printing indicates the label stop position when the media sensor is set to Gap sensor.
- You can also adjust when the operation mode is specified to Tear-off or Dispenser.

Adjust the stop position using the following procedure:

- 1 When the printer is in online mode, press the ►|| button on the operator panel to change to offline mode.
- 2 Press the ← button to show the **Settings** menu.



3 Select **Printing** using the ◀/▶ buttons, then press the ⏪ button.

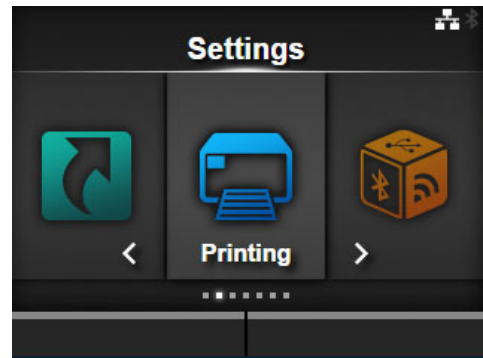

4 Select **Advanced > Adjustments > Offset** using the ▲/▼ buttons and the ⏪ button.

The Offset screen shows.

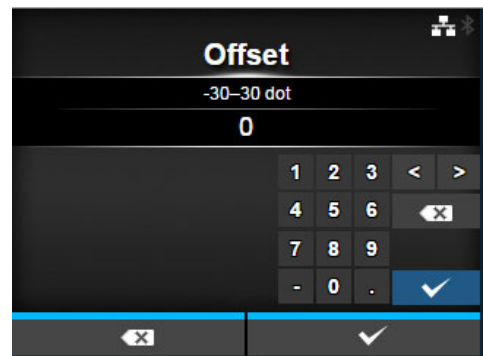

5 Change the setting value. Press the ◀/▶/▲/▼ buttons to select a number and then press the ⏪ button to enter the number to the text box.

The setting range is as follows:

<CL4NX>

- 203 dpi: -30 to +30 dots
- 305 dpi: -45 to +45 dots
- 609 dpi: -90 to +90 dots

<CL6NX>

- 203 dpi: -30 to +30 dots
- 305 dpi: -45 to +45 dots

6 Press the right soft button to save the setting value.

7 Press the ▶|| button to change to offline mode.

8 Press the ▶|| button again to change to online mode.

You can perform printing to check the adjusted stop position.

5.3.4 Notes on the Stop/Cut Position of Different Media

Stop position of the label in dispenser mode.

The regular position is to let the label stay about 2 ± 1 mm ($0.08'' \pm 0.04''$) on the liner.

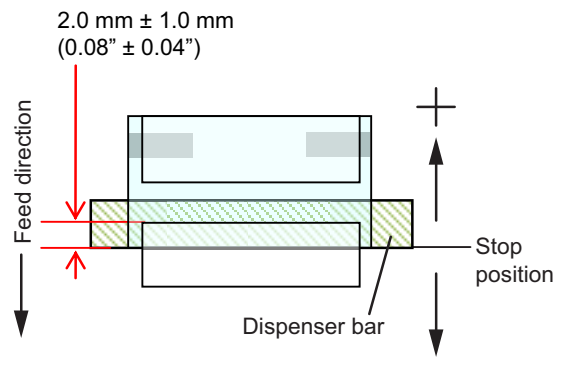

Cut position when using the label in cutter mode.

The regular cut position is between labels (only cut on the liner).

Do not cut on the label as the remaining adhesive on the blade will decrease the performance of the cutter.

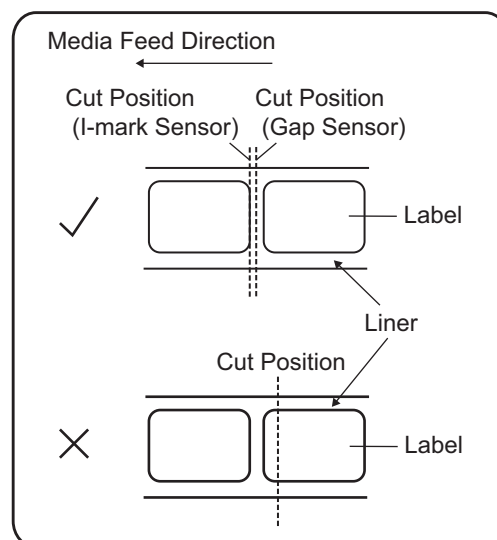

Cut position when using the media with perforated line in cutter mode.

Do not cut on the perforated line or area from the perforated line towards you. Doing so may cause a paper jam or damage.

- Media roll
Do not cut on the perforated line or within 1 mm (0.04") from the perforated line towards you.

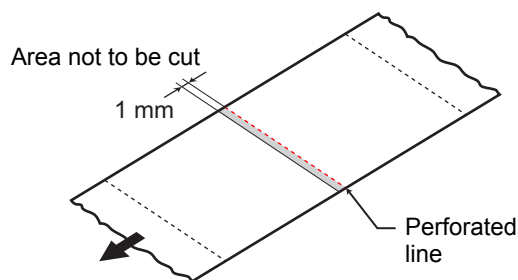

- Fan-fold media
Do not cut on the perforated line or within 4 mm to 25 mm (0.16" to 0.98") from the perforated line towards you.

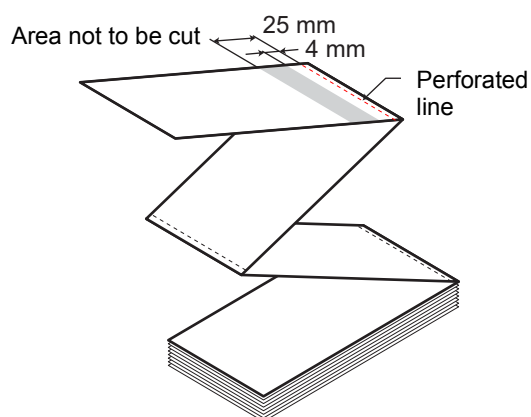

5.4 Adjusting the Print Quality

You can adjust the print quality by adjusting the print darkness and print speed.

5.4.1 Adjusting the Print Darkness

The adjustment procedure for the print darkness is as follows:

Note

- You can fine tune the print darkness by setting the **Darkness Adjust** in the **Printing > Advanced > Adjustments** menu.
- When **Prioritize** in the **Printing > Advanced** menu has been set to **Commands**, the data will be printed with the print darkness specified by command.
- To adjust the print darkness while pausing the print job, refer to [Section 4.1.5 Adjusting the Print Settings During Printing](#).

1 When the printer is in online mode, press the **▶||** button to change the printer to offline mode.

2 Press the **←** button to show the **Settings** menu.

3 Press the **◀/▶** buttons to select **Printing** and then press the **←** button.

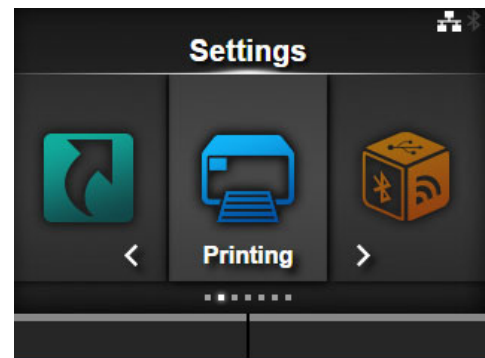

4 Press the **▲/▼** buttons to select **Darkness** and then press the **←** button.

The Darkness screen shows.

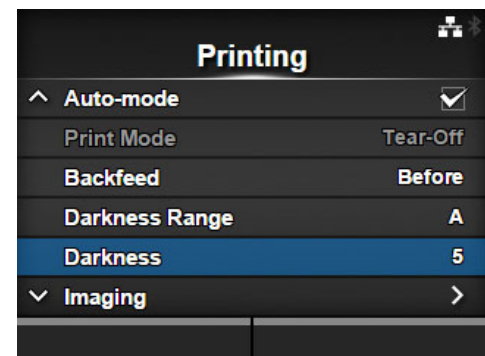

5 Press the ▲/▼ buttons to select a value.

The setting range is from 1 to 10. 1 is the lightest and 10 is the darkest.

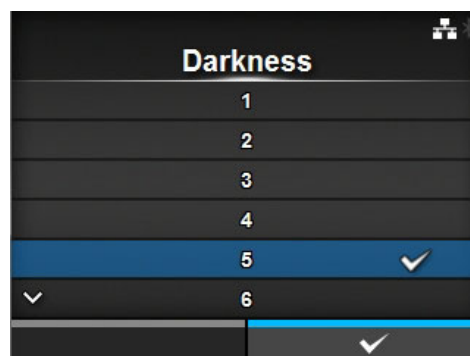
6 Press the right soft button or ← button to save the value.**7** Press the ► button to change to offline mode.**8** Press the ► button again to change to online mode.

You can perform printing to check the print quality.

5.4.2 Adjusting the Print Speed

The adjustment of the print speed not only changes the speed of printing but also affects the print quality. The setting range of the print speed varies depending on the following print resolution:

<CL4NX>

- Resolution 203 dpi (8 dots/mm): 2 to 10 (inches/sec)
- Resolution 305 dpi (12 dots/mm): 2 to 8 (inches/sec)
- Resolution 609 dpi (24 dots/mm): 2 to 6 (inches/sec)

<CL6NX>

- Resolution 203 dpi (8 dots/mm): 2 to 10 (inches/sec)
- Resolution 305 dpi (12 dots/mm): 2 to 8 (inches/sec)

Note

- When **Prioritize** in the **Printing > Advanced** menu has been set to **Commands**, the data will be printed with the print speed specified by command.
- To adjust the print speed while pausing the print job, refer to [Section 4.1.5 Adjusting the Print Settings During Printing](#).

Note (CL4NX only)

If the optional linerless cutter kit is installed, the setting range will be from 2 to 6 ips (inches/sec) regardless of the print resolution of the printer.

The adjustment procedure for the print speed is as follows:

1 When the printer is in online mode, press the ► button to change the printer to offline mode.

2 Press the **←** button to show the **Settings** menu.

3 Press the **◀/▶** buttons to select **Printing** and then press the **←** button.

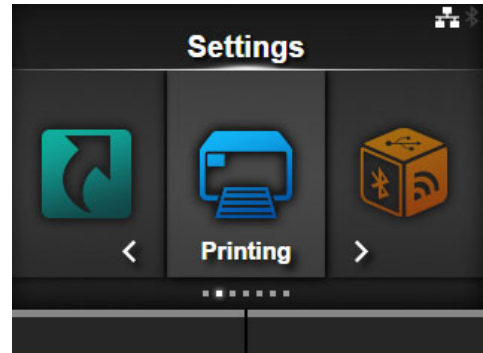

4 Press the **▲/▼** buttons to select **Speed** and then press the **←** button.

The Speed screen shows.

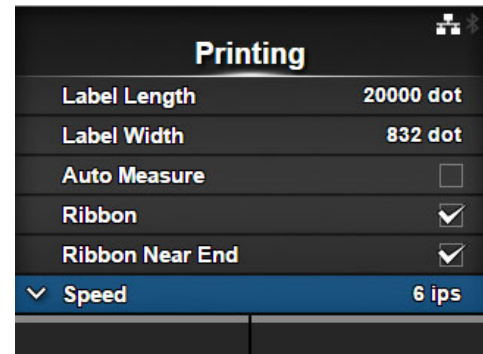

5 Press the **▲/▼** buttons to select a value.

6 Press the right soft button or **←** button to save the value.

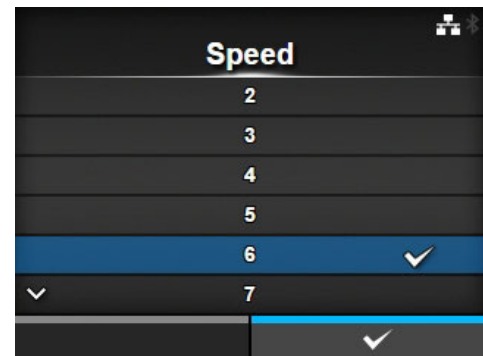

7 Press the **▶||** button to change to offline mode.

8 Press the **▶||** button again to change to online mode.
You can perform printing to check the print quality.

5.5 Adjusting the Buzzer Volume

The adjustment procedure for the buzzer volume when an error occurs is as follows:

- 1 When the printer is in online mode, press the **▶||** button on the operator panel to change to offline mode.
- 2 Press the **←** button to show the **Settings** menu.
- 3 Press the **◀/▶** buttons to select **System** and then press the **←** button.

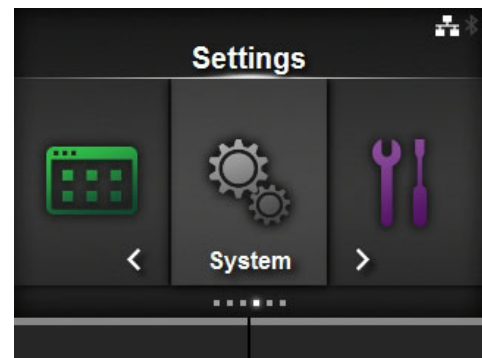

- 4 Select **Sound > Error Sound** using the **▲/▼** buttons and then press the **←** button.

The Error Sound screen shows.

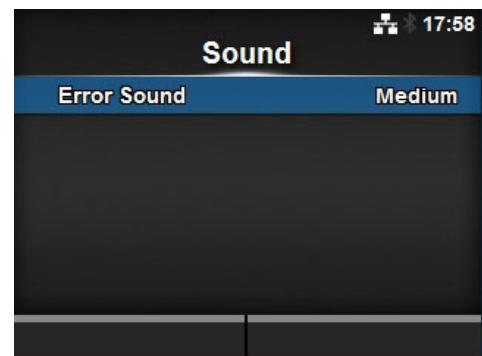

- 5 Press the **▲/▼** buttons to set the volume.

The options are as follows:

- **Off:** Mute the sound.
- **Low:** Low volume.
- **Medium:** Medium volume.
- **High:** High volume.

- 6 Press the right soft button or **←** button to save the setting.

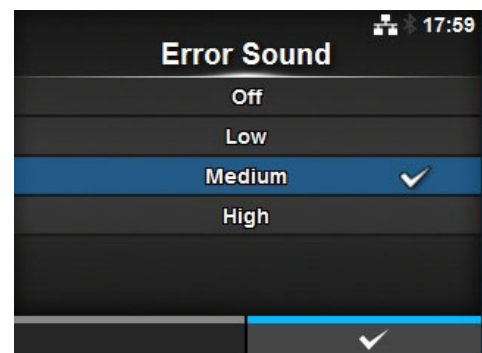

5.6 Adjusting the Head Pressure Balance

Print head balance refers to the equalization of pressure between the print head and the platen roller. If the print head balance is out of adjustment, the printed image will be darker on one side of the media than the other and the media will be prone to travel in the direction of greater pressure.

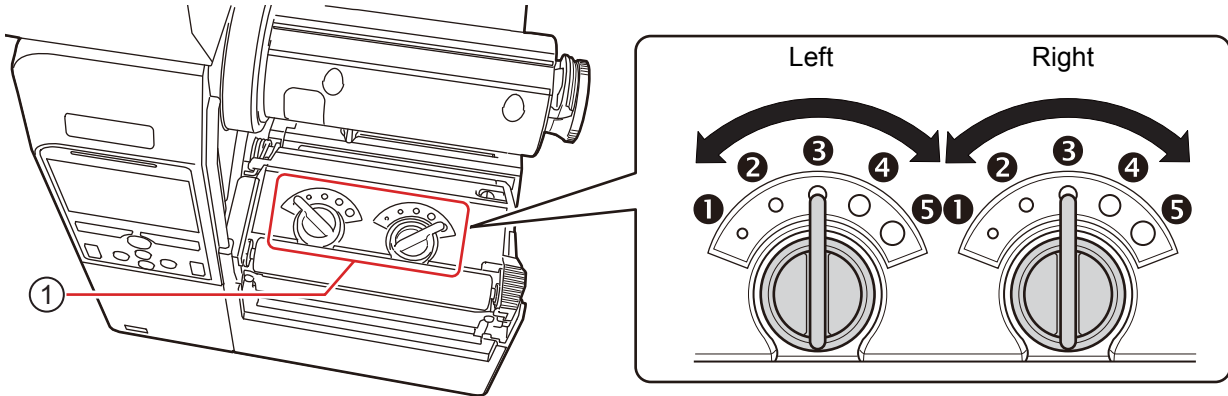

Setting the Criteria of the Head Pressure Balance

- Set the head pressure according to the media thickness, including the liner.
- Set the pressure balance according to the media width.

5.6.1 Head Pressure Setting

The adjustment procedure for the head pressure is as follows:

- 1 Open the **top cover** of the printer.
- 2 Find the **adjustment dials** ① on the top of the **print head assembly** as shown.
- 3 Turn the **adjustment dials** ① to match the media thickness.

Media Thickness (mm)	0.060-0.200	0.200 - 0.268
Adjustment Dials	③ (Left and Right, CL4NX only) ③ to ④ (Left and Right, CL6NX only)	④ to ⑤ (Left and Right)
Reference	Thin paper/normal label, etc.	Thick paper/tag, etc.

- 4 Be sure to perform the pressure balance setting as explained below, after step 3.

Note

- The factory default setting is Left ⑤ and Right ⑤.
For CL6NX dispenser model, the factory default setting is Left ④ and Right ④.
- The thickness of the media includes the liner.

5.6.2 Pressure Balance Setting

The adjustment procedure for the pressure balance is as follows:

- 1** Open the **top cover** of the printer.
- 2** Find the **adjustment dials** ① on the top of the **print head assembly** as shown.
- 3** Turn the **adjustment dials** ① according to the media width and set the pressure balance.

For CL4NX:

Media Width (mm)	25 - 54	54 - 83	83 - 131
Adjustment Dials	Left ③ Right ①	Left ③ Right ②	Left ③ Right ③

*First use the dial setting for the head pressure and then adjust according to the media width. Above table shows an example when the head pressure is Left ③.

For CL6NX:

Media Width (mm)	50 - 120	120 - 140	140 - 160	160 - 180
Adjustment Dials	Left ⑤ Right ①	Left ③ or ④ Right ①	Left ③ or ④ Right ②	Left ③ or ④ Right ③ or ④

*First use the dial setting for the head pressure and then adjust according to the media width.

Note

The factory default setting is Left ③ and Right ③.

For CL6NX dispenser model, the factory default setting is Left ④ and Right ④.

This page is intentionally left blank.



6



Troubleshooting



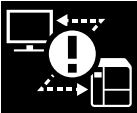
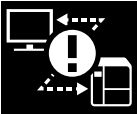

This chapter explains the errors that can occur on the printer and the displays for indicating the current status.

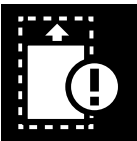

6.1 When an Error Message Occurs



When there is an error on the printer, the error message will show on the screen. The error message, its cause and the countermeasures are as follows:



Error			
No.	Message	Cause	Countermeasure
1001	Machine error  To clear the error: Power off the printer.	Defective circuit board.	Replace the main board.
1003	Parity error  To clear the error: Press the Offline or ► button, or adjust the settings.	RS-232C settings are incorrect.	Adjust the interface settings correctly.
		The cable connection is incorrect.	Check and connect the cable correctly.
1004	Overrun error  To clear the error: Press the Offline or ► button, or adjust the settings.	RS-232C settings are incorrect.	Adjust the interface settings correctly.
		The cable connection is incorrect.	Check and connect the cable correctly.
1005	Framing error  To clear the error: Press the Offline or ► button, or adjust the settings.	RS-232C settings are incorrect.	Adjust the interface settings correctly.
		The cable connection is incorrect.	Check and connect the cable correctly.
1006	Buffer overflow  To clear the error: Press the Offline or ► button.	The size of the received data exceeds the size of the receive buffer.	Do not send data that exceeds the size of the receive buffer.
		The communication settings between the printer and the host are incorrect.	Set the communication between the printer and the host correctly.



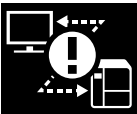

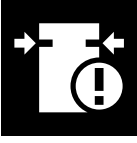
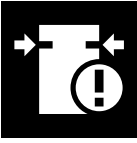

Error			
No.	Message	Cause	Countermeasure
1007	Head open	The print head is unlocked.	Lock the print head.
	 <p>To clear the error: Close the print head.</p>	The sensor for sensing the open/close status of the print head is defective.	Replace the sensor for sensing the open/close status of the print head.
1008	Out of paper	The media is not loaded.	Load the media correctly.
	 <p>To clear the error: Load the media and open/close the print head or press the Offline or ► button.</p>	The media is not loaded correctly.	
		The sensitivity of the media sensor is not set correctly.	Adjust the sensor level.
		The media has jammed.	Remove the jammed media.
		The media sensor is dirty.	Clean the media sensor.
		The cable of the media sensor is disconnected.	Connect the cable of the media sensor correctly.
1009	Ribbon end	The ribbon is not loaded.	Load a new ribbon.
	 <p>To clear the error: Load the ribbon correctly and close the print head or press the Offline or ► button.</p>	The ribbon is damaged.	
		The ribbon is not loaded correctly.	Load the ribbon correctly.
1010	Media error	The configured media size and loaded media size are different.	Check the configured media size and loaded media size.
	 <p>To clear the error: Press the Offline or ► button or open/close the print head.</p>	The received print data is larger than the configured media size.	Check the print data.
		The media is fed a longer distance due to the incorrect sensor level.	Adjust the sensor level.

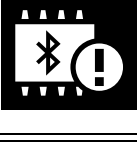

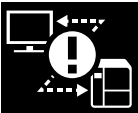
Error			
No.	Message	Cause	Countermeasure
1012	Head error  To clear the error: Power off or change the head check conditions. To forcibly clear the head error and resume printing, press and hold the DISMISS button until the progress bar on the blue line of the button reaches to the right end.	The print elements are worn out.	Change print head check conditions to only check for missing elements in barcodes and try to adjust missing elements to white bars.
		The print head is damaged.	Replace the print head.
1013	USB R/W error  To clear the error: Insert USB memory, remove USB memory or press the Offline or ►► button.	The USB memory is disconnected while writing.	Connect the USB memory.
		The copy area in the USB memory is not sufficient.	Make sure that the USB memory has sufficient copy area.
		Writing to the USB memory fails.	Replace the USB memory.
		The USB memory is not formatted.	Format the USB memory.
1014	USB memory full  To clear the error: Use USB memory with sufficient space or press the Offline or ►► button.	The space in the USB memory is not sufficient.	Delete unwanted data from the USB memory.
1015	Cutter error  To clear the error: Press the FEED button.	A media jam has occurred in the cutter unit.	Remove the jammed media from the cutter unit.
		The cutter blade does not return to the specified position.	Press the FEED button to move the cutter blade back to the specified position.

Error			
No.	Message	Cause	Countermeasure
1016	Cutter cover open	The cutter-open lever is open.	Close and lock the cutter-open lever.
	 To clear the error: Close the bracket of the cutter.	The cable of the cutter unit is disconnected.	Connect the cable of the cutter unit correctly.
		The cutter open sensor is defective.	Replace the cutter open sensor.
1017	SBPL command error	Incorrect command or parameter in the print data. Caaa: position of error occurrence <bb>: error command name cc: error code	Check the print data.
1018	RFID tag error (CL4NX only)	Could not read/write to the RFID inlay.	Discard this tag.
1019	RFID system error (CL4NX only)	RFID module is not operating correctly.	Contact the technical support center for repair of the RFID module.
	 To clear the error: Power off the printer.		

Error			
No.	Message	Cause	Countermeasure
1020	<p>Calendar error</p> <hr/>  <p>To clear the error: Change the calendar setting, press the Offline or ► button, or power off the printer.</p>	The date and time of the calendar are incorrect.	Check if you have installed the RTC kit or replace the RTC PCB.
1021	<p>BCC check error</p> <hr/>  <p>To clear the error: Press the ► button or cancel the print job.</p>	The BCC code of the data to be sent (one item) is incorrect.	<p>Check the data to be sent and communication settings.</p> <p>► button: Continue printing from the print data where the BCC error occurred.</p> <p>Send the SUB command: Clear the BCC error and continue printing from where it stopped.</p>
1022	<p>Print head overheated</p> <hr/>  <p>To clear the error: Stop the operation of the printer and wait until the temperature decreases.</p>	The temperature of the printer has exceeded its tolerance value.	Stop the operation of the printer to let the temperature decrease.
1023	<p>NTP error</p> <hr/>  <p>To clear the error: Press the Offline button or change the calendar setting.</p>	Could not connect to the time server and set the calendar clock.	<p>Confirm that the address of the time server is correct.</p> <p>Confirm that there is a connection to the time server.</p> <p>If RTC kit is installed, the calendar can be set manually and operation resumed without NTP functionality. To check or set the clock, go to the System settings menu and set the Date and Time.</p>

Error			
No.	Message	Cause	Countermeasure
1024	Head density changed	The print head is not installed.	Install the print head.
	 <p>To clear the error: Confirm the prompted message.</p>	A new print head with a different resolution has been installed.	Install a print head with the same resolution as the old print head.
1028	Gap not found	Meandering media.	Clean and adjust the media path.
	 <p>To clear the error: Press the Offline button or open/close the print head.</p>	The sensor type is incorrect.	Use the correct sensor type.
		The media sensor level is incorrect.	Adjust the media sensor level.
1035	I-mark not found	Meandering media.	Clean and adjust the media path.
	 <p>To clear the error: Press the Offline button or open/close the print head.</p>	The sensor type is incorrect.	Use the correct sensor type.
		The media sensor level is incorrect.	Adjust the media sensor level.
1046	EAP authentication error (EAP failure)	EAP Authentication failure.	Use the correct Wi-Fi settings.
1047	EAP authentication error (EAP timeout)	EAP Authentication failure.	Use the correct Access Point (AP) and authentication server settings.
	 <p>To clear the error: Press the Offline button.</p>		
1050	Bluetooth error	Bluetooth module is defective.	Contact the technical support center for repair of the Bluetooth module.
1050	 <p>To clear the error: Confirm the prompted message.</p>		

Error			
No.	Message	Cause	Countermeasure
1058	<p>CRC check error</p>  <p>To clear the error: Press the left or right soft button.</p>	<p>CRC has not been added to the data.</p> <p>CRC does not match.</p>	<p>Check transmitted data and interface settings.</p> <p>Right soft button: Continue printing from the print data where the CRC error occurred.</p> <p>Left soft button: Cancel the print data with the CRC error and continue printing from the next item.</p>
1066	<p>Paper jam (CL4NX only)</p>  <p>To clear the error: Open the print head and load the media again.</p>	<p>The media has jammed.</p>	<p>Remove the jammed media. Load the media again.</p>
1073	<p>Non-RFID warning (CL4NX only)</p>  <p>To clear the error: Press the Cancel button.</p>	<p>With Non-RFID warning enabled and RFID tag loaded, the items received do not contain an RFID issue command.</p>	<p>Add an RFID issue command to the print job.</p> <p>Disable Non-RFID warning.</p> <p>Replace with non-RFID label.</p>
1075	<p>NFC error</p>  <p>To clear the error: Press the Offline button.</p>	<p>The NFC module is not operating correctly.</p>	<p>A replacement of the NFC module is required.</p>
1076	<p>Invalid command in NFC</p>  <p>To clear the error: Press the Offline button.</p>	<p>A command error occurs and the settings are not saved correctly.</p>	<p>Check the command.</p>
1077	<p>Barcode reader connection error</p>  <p>To clear the error: Connect the barcode checker, or press the Offline button.</p>	<p>The barcode checker is not detected at printer startup or at the start of printing when the barcode checking mode is enabled.</p>	<p>Check and connect the barcode checker correctly.</p> <p>If you do not use the barcode check function, disable the barcode check mode.</p>

Error			
No.	Message	Cause	Countermeasure
1078	<p>Barcode reading error</p>  <p>To clear the error: Press the Offline or Cancel button. •Press the Offline button to change to offline mode while keeping the print job. •Press the Cancel button to cancel the print job and change to offline mode.</p>	Could not read the barcode normally.	<p>Check the layout for printing.</p> <p>Check the position of the barcode checker and settings.</p>
1079	<p>Barcode reading error (checking start position abnormality)</p>  <p>To clear the error: Press the Offline button. The printer changes to offline mode while keeping the print job.</p>	A value larger than the loaded media length is specified for checking start position.	<p>Check the layout for printing.</p> <p>Set a value smaller than the loaded media length for checking start position.</p>
1080	<p>Barcode comparison error</p>  <p>To clear the error: Press the Offline or Cancel button. •Press the Offline button to change to offline mode while keeping the print job. •Press the Cancel button to cancel the print job and change to offline mode.</p>	The read result of the barcode does not match the print data.	Check the layout for printing and barcode checker settings.

6.1.1 More Information about Command Error

Printer motion when detecting a command error

When **Show Error** is set to ENABLE in Applications > SBPL, the command error information is shown on the error message (second line), and the print operation is paused.

This error can be cleared by pressing the left soft button **CANCEL X**, but the data in which an error is detected is discarded and cannot be printed.

Location of error occurrence

“Caaa” in the command error message shows the location of command error.

The number of ESC commands from ESC+A is shown in “aaa”.

Note that the ESC+A command is not included in the number of ESC commands, which can be shown up to 999. If the number of ESC commands exceeds 999, it is shown as “999”.

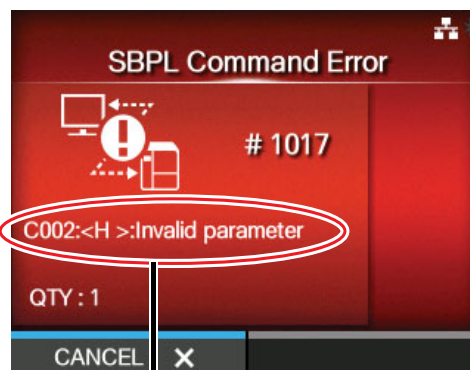

Command error information

Example)

When a command error is detected by the Horizontal Print Position <H> command.

```
-----: [ESC]A
C001: [ESC]V100
C002: [ESC]H99999          => Location of the command error
C003: [ESC]L0202
C004: [ESC]M,ABCDEF
C005: [ESC]Q1
C006: [ESC]Z
```

In this case, C002 is the location of the error.

Error command name

The command name, in which an error is detected, is shown in “<bb>”.

* A one-byte command name is left aligned.

Error description

The cause of command error will be shown in “cc” in the error message (“Caaa:<bb>:cc”).

Description (“cc”)	Cause
Invalid command	Analyzed improper command.
Invalid parameter	Received improper parameter.
Command table read error	Failed to read the command table.
Invalid graphic data/ custom designed data	Analyzed improper graphic and custom designed data.
Invalid registration area	Specified memory area (card slot) is inappropriate. Tried to write to a write-protected media.
This number is already registered	Number specified by registration command has already been taken.
Over registration area limit	Exceeded the registration area. (Memory full).

Description ("cc")	Cause
Data is not registered	Data is not registered.
Printing position is out of printable area	The specified print start position is outside the printable area.
Barcode image is out of printable area	The printing image is outside the printable area. (Barcode only).

6.2 When the LED Lights Red/Blue

The LED will light or flash to show the current status of the printer.
The status when the LED lights or flashes is as follows:

LED	Printer Status	Countermeasure
Light off.	The power is off or the printer is in offline mode.	Power on the printer or change it to online mode.
Lights blue.	The printer is in online mode.	You can operate the printer.
Flashes blue. (At intervals of 2 seconds)	The printer is in sleep mode.	You can operate the printer.
Lights red.	An error has occurred.	Clear the error according to the message.

Note

If the printer enters sleep mode during a printer error status (LED lights red), the LED indicator will flash blue at intervals of two seconds.

6.3 Troubleshooting Table

Check the items below when the printer does not operate correctly.

WARNING

- Do not touch the power button, connect or disconnect the power cord while your hands are wet. Doing so could cause an electric shock.
- Disconnect the power cord from the AC outlet before you perform the cleaning.

Note

You can purchase a cleaning kit or cleaning sheet from a SATO reseller or technical service center.

6.3.1 No Power/Nothing on the Screen

No.	What to check	Countermeasure
1	Is the power cord fully connected to the AC outlet?	Connect the power cord to the AC outlet fully.
2	Is the power cord fully connected to the printer?	Connect the power cord to the AC input terminal of the printer fully.
3	Is the power cord damaged?	Replace the power cord. Contact a SATO reseller or technical service center for the specific power cord for this printer. Do not use power cords that are not designed specifically for this printer.
4	Is there electricity at the AC outlet that supplies the power to the printer?	Check if there is electricity at the AC outlet. Connect to another AC outlet.

6.3.2 Cannot Feed the Media

No.	What to check	Countermeasure
1	Are the media and ribbon designed for the printer?	Use media and ribbon designed for the printer.
2	Are the media and ribbon loaded correctly?	Load the media and ribbon correctly.
3	Is the media or ribbon deformed?	Use the media or ribbon that is not deformed. You cannot feed the media or ribbon that is deformed.
4	Is the media guide set correctly?	Adjust the media guide.
5	Is the correct sensor type set?	Set the correct sensor type.
6	Is the sensitivity of the sensor set correctly?	Adjust the sensor level.

No.	What to check	Countermeasure
7	Is the platen roller dirty?	If the platen roller is dirty, clean it with the cleaning kit. For printer cleaning, refer to Section 5.2 Maintenance of the Print Head and Platen Roller .
8	Is the platen roller damaged?	Replace the platen roller.
9	Does the interface operate correctly?	Check the interface according to the Interface Troubleshooting.
10	Is the data or signal sent from the computer incorrect?	Power on the device again. Check the data sent from the computer and communication conditions.
11	Is the main board defective?	Replace the main board.

6.3.3 Can Feed the Media but Cannot Print

No.	What to check	Countermeasure
1	Are the media and ribbon designed for use with the printer?	Use the media and ribbon designed for the printer.
2	Is the ribbon wound correctly?	If the knob of the ribbon rewinder is not set to its initial position, remove the wound ribbon then set the knob again.
3	Is the correct sensor type set?	Set a correct sensor type.
4	Is the print head installed correctly?	Install the print head correctly.
5	Is the pressure of the print head too strong or too weak?	Adjust the pressure of the print head with the head pressure adjustment dial.
6	Is the print head dirty or is there a label attached to it?	If the print head is dirty, clean it using the cleaning pen. If a label is attached to the print head, remove it. If the glue of label is attached to the print head, clean it using a cleaning kit. Do not clean using a hard object. Doing so could cause damage to the print head. For printer cleaning, refer to Section 5.2 Maintenance of the Print Head and Platen Roller .
7	Is the media sensor dirty?	If the media sensor is dirty, clean it using the cleaning kit. For printer cleaning, refer to Section 5.2 Maintenance of the Print Head and Platen Roller .
8	Does the interface operate correctly?	Check the interface according to the Interface Troubleshooting.
9	Is the data or signal sent from the computer incorrect?	Power on the device again. Check the data sent from the computer and communication conditions.

No.	What to check	Countermeasure
10	Is the print head defective?	Replace the print head and reset the counter.
11	Is the main board defective?	Replace the main board.

6.3.4 Bad Print Quality

No.	What to check	Countermeasure
1	Are the media and ribbon designed for use with the printer?	Use media and ribbon designed for the printer.
2	Are the media and ribbon loaded correctly?	Check if the media and ribbon are loaded correctly.
3	Is the tension of the ribbon correct?	Adjust the tension of the ribbon.
4	Is the print head installed correctly?	Install the print head correctly.
5	Is the pressure of the print head too strong or too weak?	Adjust the pressure of the print head with the head pressure adjustment dial.
6	Is the print speed too fast?	Adjust the print speed.
7	Is the print darkness too low or too high?	Adjust the print darkness.
8	Is the platen roller dirty?	If the platen roller is dirty, clean it using the cleaning kit. For printer cleaning, refer to Maintenance.
9	Is the print head dirty or is there a label attached to it?	If the print head is dirty, clean it using the cleaning pen. If a label is attached to the print head, remove it. If the glue of label is attached to the print head, clean it using a cleaning kit. Do not clean using a hard object. Doing so could cause damage to the print head. For printer cleaning, refer to Section 5.2 Maintenance of the Print Head and Platen Roller .
10	Is the print head defective?	Replace the print head and reset the counter.
11	Is the platen roller damaged?	Replace the platen roller.
12	Is the main board defective?	Replace the main board.

6.3.5 Incorrect Print Position

No.	What to check	Countermeasure
1	Are the media and ribbon designed for use with the printer?	Use media and ribbon designed for the printer.
2	Are the media and ribbon loaded correctly?	Check if the media and ribbon are loaded correctly.
3	Is the media or ribbon deformed?	Use the media or ribbon that is not deformed. You cannot feed the media or ribbon that is deformed.
4	Is the print head installed correctly?	Adjust the print head.
5	Is the media guide set correctly?	Adjust the media guide.
6	Is the correct sensor type set?	Set the correct sensor type.
7	Is the sensitivity of the sensor set correctly?	Adjust the sensor level.
8	Is the offset set correctly?	Adjust the offset.
9	Is the pitch offset or base reference point offset set correctly?	Adjust the pitch offset or base reference point offset.
10	Is the platen roller dirty?	If the platen roller is dirty, clean it using the cleaning kit. For printer cleaning, refer to Section 5.2 Maintenance of the Print Head and Platen Roller .
11	Is the media sensor dirty?	If the media sensor is dirty, clean it using the cleaning kit. For printer cleaning, refer to Section 5.2 Maintenance of the Print Head and Platen Roller .
12	Is the data or signal sent from the computer incorrect?	Power on the device again. Check the data sent from the computer and communication conditions.
13	Is the platen roller damaged?	Replace the platen roller.

6.3.6 Cannot Read Barcodes When Using the Barcode Check Function

No.	What to check	Countermeasure
1	Is the barcode checker connected to the printer?	Connect the barcode checker to the printer correctly. For details, refer to the Barcode Checker Stand Kit Installation Manual that came with the barcode checker stand kit.
2	Is the barcode checker icon displayed in the status bar at the upper right of the display?	If the icon is not displayed, power the printer off and then on, and check if the icon appears.
3	Is the barcode check function enabled?	Enable the barcode check function. For details, refer to Section 7.6.5 Enabling the Barcode Check .
4	Was the test read with the barcode checker successful?	Perform a test read with the barcode checker. For details, refer to Section 7.6.4 Doing a Test Read with the Barcode Checker . If the test read is successful, check the readability by actually printing.
5	Is the printing normal?	Check the condition of the printed barcode.
6	Are the position and angle of the barcode checker correct?	Adjust the position and angle of the barcode checker. For details, refer to the Barcode Checker Stand Kit Installation Manual that came with the barcode checker stand kit.
7	Is the print head dirty?	If the print head is dirty, clean it using the cleaning pen. Do not clean it using a hard object. Doing so could cause damage to the print head. For printer cleaning, refer to Section 5.2 Maintenance of the Print Head and Platen Roller .
8	Are the media and ribbon loaded correctly?	Load the media and ribbon correctly.
9	Is the print head defective?	Replace the print head and reset the counter.

6.4 Interface Troubleshooting

When an interface error occurs on the printer, check with the checklist related to that interface.

6.4.1 USB Interface

No.	Item to check
1	Check that the USB cable is connected correctly.
2	Check that the cable is not damaged.
3	Check the configuration of the printer. Check the setting of the USB interface through the Settings > Interface > USB menu.
4	If there are multiple USB ports on the computer, connect to another port.
5	Disconnect other USB devices from the computer.
6	Power on the printer and computer again.
7	Install the USB driver again.

6.4.2 LAN Ethernet Interface

No.	Item to check
1	Check that the LAN cable is connected correctly.
2	Check that the cable is not damaged.
3	Check the configuration of the printer. Check the setting of the LAN Ethernet interface through the Settings > Interface > Network menu.
4	Check that the allocated IP address is accessible by PING.
5	Check that the power of the HUB is on.
6	Check that the HUB is not defective.
7	Power on the printer again.

6.4.3 Bluetooth Interface

No.	Item to check
1	Check that the Bluetooth function is on.
2	Check that the devices using the same frequency band, such as wireless LAN enabled devices or microwaves are not in use.
3	Check that there is no obstacle such as a metal rack between the printer and the host.
4	Check the configuration of the printer. Check the setting of the Bluetooth interface through the Settings > Interface > Bluetooth menu.
5	Power on the printer and computer again.
6	Install the Bluetooth driver again.

6.4.4 NFC Interface

No.	Item to check
1	Check that the NFC interface is enabled. Check the setting of the NFC interface through the Settings > Interface > NFC menu.
2	Touch the NFC antenna of the printer with the NFC mark on the Android device.
3	Shift the Android device to the front, back, left and right, and then hold it up again.

6.4.5 RS-232C Interface

No.	Item to check
1	Check that the RS-232C cable is connected correctly.
2	Check that the cable is not damaged.
3	Check the configuration of the printer. Check the setting of the RS-232C interface through the Settings > Interface > RS-232C menu.
4	If there are multiple RS-232C ports on the computer, connect to another port.
5	Power on the printer and computer again.
6	Check that no other software is using the same RS-232C port.

6.4.6 IEEE1284 Interface

No.	Item to check
1	Check that the printer cable is connected to the LPT port of the computer correctly.
2	Check that the cable is not damaged.
3	If you are using a Windows printer driver, check that the correct port is selected.
4	Check the configuration of the printer. Check the setting of the IEEE1284 interface through the Settings > Interface > IEEE1284 menu.
5	Connect to another port.
6	Power on the printer again.

6.4.7 External Signal Interface (EXT)

No.	Item to check
1	Check that the printer and external device are connected with a cable correctly.
2	Check that the cable is not damaged.
3	Check that the power of the external device is on.
4	Check the configuration of the printer. Check the setting of the external signal (EXT) interface through the Settings > Interface > External I/O menu.
5	Power on the printer and external device again.

6.4.8 Wireless LAN Interface

No.	Item to check
1	Check that the wireless LAN function is on.
2	Check that the devices using the same frequency band, such as wireless LAN enabled devices or microwaves are not in use.
3	Check that there is no obstacle such as a metal rack between the printer and the host.
4	Check the configuration of the printer. Check the setting of the wireless LAN interface through the Settings > Interface > Network > Settings > Wi-Fi menu.
5	Power on the printer again.

This page is intentionally left blank.

7

Appendix

7.1 List of Initial Values

The initial value refers to the setting value of the printer when it was shipped from the factory. If you reset the printer, the setting values of the printer will change back to the factory default values. The tables below show the initial value of each setting item and type of reset that changes the value back to the initial value.

CAUTION

It is generally not necessary to perform the initialization. Doing so will remove all the customer settings.

7.1.1 Printing Menu

Setting Item	Initial Value		User Reset	Factory Reset
	CL4NX	CL6NX		
Label Length	203 dpi: 20000 dots 305 dpi: 18000 dots 609 dpi: 9600 dots	203 dpi: 20000 dots 305 dpi: 18000 dots	Yes	Yes
Label Width	203 dpi: 832 dots 305 dpi: 1248 dots 609 dpi: 2496 dots	if Head Base Position is Standard 203 dpi: 1216 dots 305 dpi: 1984 dots if Head Base Position is Left-justify 203 dpi: 1340 dots 305 dpi: 2010 dots	Yes	Yes
Auto Measure	Disabled		Yes	Yes
Ribbon	Use Ribbon		Yes	Yes
Ribbon Near End	Enabled		Yes	Yes
Speed	203 dpi: 6 ips 305 dpi: 6 ips 609 dpi: 4 ips Linerless mode: 4 ips	203 dpi: 6 ips 305 dpi: 6 ips	Yes	Yes
Sensor Type	Gap None (When Print Mode is Linerless)	Gap	Yes	Yes
Auto-mode	Enabled		Yes	Yes

Setting Item	Initial Value		User Reset	Factory Reset
	CL4NX	CL6NX		
Print Mode	Tear-Off (No option is installed) Cutter (If cutter is installed) Dispenser (If dispenser is installed) Linerless (If linerless cutter kit is installed)	Tear-Off (No option is installed) Cutter (If cutter is installed) Dispenser (If dispenser is installed)	Yes	Yes
Backfeed	Before (If Print Mode is set to Tear-Off or Linerless) After (If Print Mode is set to Dispenser, Cutter, or Cut & Print) None (If Print Mode is set to Continuous)	Before (If Print Mode is set to Tear-Off) After (If Print Mode is set to Dispenser, Cutter, or Cut & Print) None (If Print Mode is set to Continuous)	Yes	Yes
Eject Cut	Off		Yes	Yes
Darkness Range	A		Yes	Yes
Darkness	5		Yes	Yes
Imaging	—		—	—
Vertical	0 dot		Yes	Yes
Horizontal	0 dot		Yes	Yes
Advanced	—		—	—
Calibrate	—		—	—
Auto-calibration*1	Gap + I-Mark		—	—
GAP Levels	Value adjusted by the factory.		No	No
GAP Slice Level	Auto		No	No
I-Mark Levels	Value adjusted by the factory.		No	No
I-Mark Slice Level	Auto		No	No
Head Check	Off		Yes	Yes
Head Check Mode	Always		Yes	Yes
Every Page	1		Yes	Yes
Check Media Size	Disabled		Yes	Yes
Adjustments	—		—	—
Offset	0 dot		No	No
Pitch	0 dot		No	No
Darkness Adjust	50		No	No
Start Online	Enabled		Yes	Yes

*1 Auto-calibration is not available for linerless models.

Setting Item	Initial Value		User Reset	Factory Reset
	CL4NX	CL6NX		
Feed After Error	Disabled		Yes	Yes
Feed At Power On	Disabled		Yes	Yes
Finisher Feed	0 dot (Standard)		Yes	Yes
Paper End	Using I-mark		Yes	Yes
Head Base Position	Standard		Yes	Yes
Prioritize	Commands		Yes	Yes
Reprint	Disabled		Yes	Yes
Print End Position	0 dot		Yes	Yes
Label Near End	Disabled		Yes	Yes

7.1.2 Interface Menu

Setting Item	Initial Value		User Reset	Factory Reset
	CL4NX	CL6NX		
Network	—		—	—
Settings	—		—	—
LAN	—		—	—
IPv4	—		—	—
Mode	DHCP		Yes/ Interface	Yes/ Interface
DHCP	—		—	—
IP Address	0.0.0.0		Yes/ Interface	Yes/ Interface
Netmask	255.255.255.0		Yes/ Interface	Yes/ Interface
Gateway	0.0.0.0		Yes/ Interface	Yes/ Interface
DNS	0.0.0.0		Yes/ Interface	Yes/ Interface
IPv6	—		—	—
Mode	Disable		Yes/ Interface	Yes/ Interface
DHCP	—		—	—
IP Address	::		Yes/ Interface	Yes/ Interface
Prefix Length	64		Yes/ Interface	Yes/ Interface
Gateway	::		Yes/ Interface	Yes/ Interface
DNS	::		Yes/ Interface	Yes/ Interface
Proxy	—		—	—
Enabled	Disabled		Yes/ Interface	Yes/ Interface
Server	—		Yes/ Interface	Yes/ Interface
Exclude	—		Yes/ Interface	Yes/ Interface
Wi-Fi	—		—	—
IPv4	—		—	—

Setting Item	Initial Value		User Reset	Factory Reset
	CL4NX	CL6NX		
Mode	DHCP		Yes/ Interface	Yes/ Interface
DHCP	—		—	—
IP Address	0.0.0.0		Yes/ Interface	Yes/ Interface
Netmask	255.255.255.0		Yes/ Interface	Yes/ Interface
Gateway	0.0.0.0		Yes/ Interface	Yes/ Interface
DNS	0.0.0.0		Yes/ Interface	Yes/ Interface
IPv6	—		—	—
Mode	Disable		Yes/ Interface	Yes/ Interface
DHCP	—		—	—
IP Address	::		Yes/ Interface	Yes/ Interface
Prefix Length	64		Yes/ Interface	Yes/ Interface
Gateway	::		Yes/ Interface	Yes/ Interface
DNS	::		Yes/ Interface	Yes/ Interface
Proxy	—		—	—
Enabled	Disabled		Yes/ Interface	Yes/ Interface
Server	—		Yes/ Interface	Yes/ Interface
Exclude	—		Yes/ Interface	Yes/ Interface
Wi-Fi Protected Setup	—		—	—
Button (PBC)	—		—	—
PIN	—		—	—
Wi-Fi Direct	—		—	—
Device Name	SATO_PRINTER		Yes/ Interface	Yes/ Interface
Connect	—		—	—
Start Group	—		—	—
Remove Group	—		—	—

Setting Item	Initial Value		User Reset	Factory Reset
	CL4NX	CL6NX		
Disconnect	—		—	—
SSID	DIRECT-xx-SATO_PRINTER		—	—
IP Address	x.x.x.x		—	—
Passphrase	xxxxxxx		—	—
SSID	SATO_PRINTER		Yes/ Interface	Yes/ Interface
Hidden SSID	Enabled		Yes/ Interface	Yes/ Interface
Mode	Ad-hoc		Yes/ Interface	Yes/ Interface
Channel	6		Yes/ Interface	Yes/ Interface
Security	None		Yes/ Interface	Yes/ Interface
WEP Conf.	—		—	—
Authentication	Open System		Yes/ Interface	Yes/ Interface
Key Index	1		Yes/ Interface	Yes/ Interface
Key #1 - Key #4	—		Yes/ Interface	Yes/ Interface
WPA Conf.	—		—	—
WPA Authentication	Personal (PSK)		Yes/ Interface	Yes/ Interface
PSK	—		Yes/ Interface	Yes/ Interface
EAP Conf.	—		Yes/ Interface	Yes/ Interface
EAP Conf.	—		—	—
EAP Mode	FAST		Yes/ Interface	Yes/ Interface
Inner Method	MSCHAPv2		Yes/ Interface	Yes/ Interface
Username	—		Yes/ Interface	Yes/ Interface
Password	—		Yes/ Interface	Yes/ Interface
Anon. Outer ID	—		Yes/ Interface	Yes/ Interface

Setting Item	Initial Value		User Reset	Factory Reset
	CL4NX	CL6NX		
Verify Server Cert.	Enabled		Yes/ Interface	Yes/ Interface
Private Key P/W	—		Yes/ Interface	Yes/ Interface
PAC Auto Provisioning	Disabled		Yes/ Interface	Yes/ Interface
PAC P/W	—		Yes/ Interface	Yes/ Interface
Interface	Auto		Yes/ Interface	Yes/ Interface
Services	—		—	—
Ports	—		—	—
Port1	1024		Yes/ Interface	Yes/ Interface
Port2	1025		Yes/ Interface	Yes/ Interface
Port3	9100		Yes/ Interface	Yes/ Interface
Flow Control	Status4 ENQ		Yes/ Interface	Yes/ Interface
Multiple connections	Disabled		Yes/ Interface	Yes/ Interface
Legacy Status for Port 9100	Disabled		Yes/ Interface	Yes/ Interface
BCC	Disabled		Yes/ Interface	Yes/ Interface
NTP	—		—	—
Enable	Disabled		No	Yes
Error	Disabled		No	Yes
Time Server IP	0.0.0.0		No	Yes
LPD	—		—	—
Enable	Enabled		Yes/ Interface	Yes/ Interface
DNS Lookup	Disabled		Yes/ Interface	Yes/ Interface
FTP	—		—	—
Enable	Disabled		Yes/ Interface	Yes/ Interface
FTP Timeout	300 sec		Yes/ Interface	Yes/ Interface

Setting Item	Initial Value		User Reset	Factory Reset
	CL4NX	CL6NX		
SNMP	—		—	—
sysContact	—		Yes/ Interface	Yes/ Interface
sysName	—		Yes/ Interface	Yes/ Interface
sysLocation	—		Yes/ Interface	Yes/ Interface
prtMarkerCounterUnit	meters		Yes/ Interface	Yes/ Interface
Agent	—		—	—
Enable	Enabled		Yes/ Interface	Yes/ Interface
Read-Only	—		—	—
SNMP Version	1 2c 3		Yes/ Interface	Yes/ Interface
Community	public		Yes/ Interface	Yes/ Interface
User	rouser		Yes/ Interface	Yes/ Interface
User Security	None		Yes/ Interface	Yes/ Interface
Authentication Protocol	MD5		Yes/ Interface	Yes/ Interface
Authentication Passphrase	mypassword		Yes/ Interface	Yes/ Interface
Privacy Protocol	DES		Yes/ Interface	Yes/ Interface
Privacy Passphrase	mypassword		Yes/ Interface	Yes/ Interface
Read-Write	—		—	—
SNMP Version	Disabled		Yes/ Interface	Yes/ Interface
Community	private		Yes/ Interface	Yes/ Interface
User	rwuser		Yes/ Interface	Yes/ Interface
User Security	None		Yes/ Interface	Yes/ Interface
Authentication Protocol	MD5		Yes/ Interface	Yes/ Interface

Setting Item	Initial Value		User Reset	Factory Reset
	CL4NX	CL6NX		
Authentication Passphrase	mypassword		Yes/Interface	Yes/Interface
Privacy Protocol	DES		Yes/Interface	Yes/Interface
Privacy Passphrase	mypassword		Yes/Interface	Yes/Interface
Traps	—		—	—
Enable	Disabled		Yes/Interface	Yes/Interface
SNMP Version	1		Yes/Interface	Yes/Interface
IP Version	4		Yes/Interface	Yes/Interface
Destinations	1		Yes/Interface	Yes/Interface
Destination 1	0.0.0.0		Yes/Interface	Yes/Interface
Destination 2	0.0.0.0		Yes/Interface	Yes/Interface
Destination 3	0.0.0.0		Yes/Interface	Yes/Interface
Community	trapcom		Yes/Interface	Yes/Interface
User	trapuser		Yes/Interface	Yes/Interface
Engine ID	Hex string generated from MAC address		Yes/Interface	Yes/Interface
Security	None		Yes/Interface	Yes/Interface
Authentication Protocol	MD5		Yes/Interface	Yes/Interface
Authentication Passphrase	mypassword		Yes/Interface	Yes/Interface
Privacy Protocol	DES		Yes/Interface	Yes/Interface
Privacy Passphrase	mypassword		Yes/Interface	Yes/Interface
Advanced	—		—	—
ARP Announcement	—		—	—
Additional	Enabled		Yes/Interface	Yes/Interface

Setting Item	Initial Value		User Reset	Factory Reset
	CL4NX	CL6NX		
Periodic	Off		Yes/ Interface	Yes/ Interface
IEEE1284	—		—	—
Flow Control	Status4 Multi		Yes/ Interface	Yes/ Interface
BCC	Disabled		Yes/ Interface	Yes/ Interface
RS-232C	—		—	—
Interface	RS-232C		Yes/ Interface	Yes/ Interface
Baudrate	115200		Yes/ Interface	Yes/ Interface
Parameters	8-N-1		Yes/ Interface	Yes/ Interface
Flow Control	STATUS4		Yes/ Interface	Yes/ Interface
BCC	Disabled		Yes/ Interface	Yes/ Interface
USB	—		—	—
Flow Control	Status4		Yes/ Interface	Yes/ Interface
BCC	Disabled		Yes/ Interface	Yes/ Interface
Bluetooth	—		—	—
Enable	Enabled		Yes/ Interface	Yes/ Interface
Name	SATO PRINTER_xxxxxxxxxxx (BD address)		Yes/ Interface	Yes/ Interface
Pin Code	0000		Yes/ Interface	Yes/ Interface
BD Address	xxxxxxxxxxx		Yes/ Interface	Yes/ Interface
Firm Version	spp3_vX.YY		Yes/ Interface	Yes/ Interface
Host BD Addr	—		Yes/ Interface	Yes/ Interface
Authentication	None		Yes/ Interface	Yes/ Interface
ISI	2048		Yes/ Interface	Yes/ Interface

Setting Item	Initial Value		User Reset	Factory Reset
	CL4NX	CL6NX		
ISW	18		Yes/ Interface	Yes/ Interface
PSI	2048		Yes/ Interface	Yes/ Interface
PSW	18		Yes/ Interface	Yes/ Interface
CRC Mode	Disabled		Yes/ Interface	Yes/ Interface
Flow Control	Status4 Multi		Yes/ Interface	Yes/ Interface
NFC	—		—	—
I/F Enable	Enabled		Yes/ Interface	Yes/ Interface
Ignore CR/LF	Disabled		Yes/ Interface	Yes/ Interface
Ignore CAN/DLE	Disabled		Yes/ Interface	Yes/ Interface
External I/O	—		—	—
Enable	Disabled		Yes/ Interface	Yes/ Interface
Signals	—		—	—
EXT 9PIN	MODE1		Yes/ Interface	Yes/ Interface
EXT Mode	TYPE4		Yes/ Interface	Yes/ Interface
Inputs	—		—	—
Start Print	PIN 5		Yes/ Interface	Yes/ Interface
Reprint	PIN 7		Yes/ Interface	Yes/ Interface
Outputs	—		—	—
Paper End/ Paper/Ribbon End (If RFID is installed)	PIN 1		Yes/ Interface	Yes/ Interface
Ribbon End/ RFID Tag Error (If RFID is installed)	PIN 3		Yes/ Interface	Yes/ Interface
Machine Error/ Machine/RFID Error (If RFID is installed)	PIN 4		Yes/ Interface	Yes/ Interface

Setting Item	Initial Value		User Reset	Factory Reset
	CL4NX	CL6NX		
Print Done	PIN 6		Yes/Interface	Yes/Interface
Qty/Offline	PIN 9		Yes/Interface	Yes/Interface
Ribbon Near End	PIN 10		Yes/Interface	Yes/Interface
Dispenser	OFF		Yes/Interface	Yes/Interface
Label Near End	OFF		Yes/Interface	Yes/Interface
EXT I/O Re-print	Disabled		Yes/Interface	Yes/Interface
RFID	—	—	—	—
Antenna Pitch	Standard	—	Yes/Interface	Yes/Interface
Write Power	10 dBm	—	Yes/Interface	Yes/Interface
Read Power	10 dBm	—	Yes/Interface	Yes/Interface
Tag Offset	0 mm	—	Yes/Interface	Yes/Interface
Reader Model	XXXXXXXXXXXXXXXXXX	—	—	—
Reader Version	XXXXXXXXXXXXXXXXXX	—	—	—
View	—	—	—	—
Memory Bank	EPC (UHF)/USER (HF)	—	Yes/Interface	Yes/Interface
Retry Mode	Retry	—	Yes/Interface	Yes/Interface
Retries	1	—	Yes/Interface	Yes/Interface
Mark bad tags	Enabled	—	Yes/Interface	Yes/Interface
MCS	—	—	—	—
MCS	Disabled	—	Yes/Interface	Yes/Interface
Chip Manufacturer	IMPINJ	—	Yes/Interface	Yes/Interface
Pre-Encoded Tag	Disabled	—	Yes/Interface	Yes/Interface
Assign Prefix	Auto	—	Yes/Interface	Yes/Interface

Setting Item	Initial Value		User Reset	Factory Reset
	CL4NX	CL6NX		
MCS Prefix Digit	3 bits	—	Yes/ Interface	Yes/ Interface
Input Prefix	0	—	Yes/ Interface	Yes/ Interface
Non-RFID Warning	Disabled	—	Yes/ Interface	Yes/ Interface
Log RFID Data	Disabled	—	Yes/ Interface	Yes/ Interface
Data To Record	EPC and TID	—	Yes/ Interface	Yes/ Interface
Output Error Mode	Level	—	Yes/ Interface	Yes/ Interface
Pulse Length	100 ms	—	Yes/ Interface	Yes/ Interface
Counters	—	—	—	—
Lifetime	—	—	—	—
Count Success	000000	—	No	Yes
Count Failure	000000	—	No	Yes
Count Total	000000	—	No	Yes
User	—	—	—	—
Count Success	000000	—	Yes	Yes
Count Failure	000000	—	Yes	Yes
Count Total	000000	—	Yes	Yes

7.1.3 Applications Menu

Setting Items	Initial Value		User Reset	Factory Reset
	CL4NX	CL6NX		
Protocol	AUTO		Yes	Yes
SBPL	—		—	—
Show Error	Disabled		Yes	Yes
Standard Code	Enabled		Yes	Yes
Orientation	Portrait		Yes	Yes
Font Settings	—		—	—
Zero Slash	Enabled		Yes	Yes
Kanji	—		—	—
Kanji Set	GB18030		Yes	Yes
Character Code	GB18030		Yes	Yes
Kanji Style	Gothic		Yes	Yes
Proportional	Enabled		Yes	Yes
Code Page	858		Yes	Yes
€	d5		Yes	Yes
Compatible	—		—	—
M-8400 Compatibility	Disabled		Yes	Yes
CODE128(C) Zero Fill	Disabled		Yes	Yes
Kanji Command	Disabled		Yes	Yes
Call Font/Logo	Disabled		Yes	Yes
ENQ Reply Delay	0 ms		Yes/ Interface	Yes/ Interface
ENQ Reply Cycle	500 ms		Yes/ Interface	Yes/ Interface
SZPL	—		—	—
Label	—		—	—
Shift	0 dot		Yes	Yes
Top	0 dot		Yes	Yes
Caret	94 (^)		Yes	Yes
Delimiter	44 (,.)		Yes	Yes
Tilde	126 (~)		Yes	Yes
Clock Format	(none)		Yes	Yes
SIPL	—		—	—
Font Settings	—		—	—

Setting Items	Initial Value		User Reset	Factory Reset
	CL4NX	CL6NX		
Code Page	1252		Yes	Yes
New Font Encoding	Disabled		Yes	Yes
c20 Proportional Pitch	Disabled		Yes	Yes
Zero Slash	Disabled		Yes	Yes
Format Save	Enabled		Yes	Yes
STCL	—		—	—
Command Head	—		—	—
Control Code	Auto		Yes	Yes
1st Byte Code	27		Yes	Yes
2nd Byte Code	10		Yes	Yes
3rd Byte Code	0		Yes	Yes
Font Settings	—		—	—
Zero Slash	Disabled		Yes	Yes
€	d5		Yes	Yes
Code Page	850		Yes	Yes
Half-width Symbol	Enabled		Yes	Yes
Rotation	0 degree		Yes	Yes
Ignore Paper Size Command	Disabled		Yes	Yes
SDPL	—		—	—
Control Code	—		—	—
Code Type	Standard		Yes	Yes
SOH	01		Yes	Yes
STX	02		Yes	Yes
CR	0D		Yes	Yes
CNTBY	5E		Yes	Yes
Label Rotation	0 degree		Yes	Yes
SOP Emulation	Auto		Yes	Yes
Compatible Mode	—		—	—
TTF	Disabled		Yes	Yes
Graphics	Disabled		Yes	Yes
Right-to-Left print	Auto		Yes	Yes
Prioritize	—		—	—
Format Attribute	Commands		Yes	Yes
Pause Mode	Commands		Yes	Yes

Setting Items	Initial Value		User Reset	Factory Reset
	CL4NX	CL6NX		
1 Byte Codepage	Commands		Yes	Yes
SDPL Measure Unit	Commands		Yes	Yes
Scalable Font Style	Commands		Yes	Yes
Darkness	Commands		Yes	Yes
Factory Offset	Commands		Yes	Yes
Speed	Commands		Yes	Yes
Sensor Type	Commands		Yes	Yes
Format Attribute	XOR		Yes	Yes
Pause Mode	Disabled		Yes	Yes
1 Byte Codepage	CP 850		Yes	Yes
SDPL Measure Unit	Inch		Yes	Yes
Scalable Font Style	—		—	—
Bold	Disabled		Yes	Yes
Italic	Disabled		Yes	Yes
SEPL	—		—	—
Home Reference	—		—	—
Horz. Offset	0 dot		Yes	Yes
Vert. Offset	0 dot		Yes	Yes
Memory Device	Internal FLASH		Yes	Yes
Sim. 300 DPI Head	Disabled		Yes	Yes
AEP	—		—	—
Enable	Disabled		No	Yes
Start Application	Standard (/rom/standalone/sa.lua)		No	Yes
Label Rotation	Disabled		Yes	Yes

7.1.4 System Menu

Setting Item	Initial Value		User Reset	Factory Reset
	CL4NX	CL6NX		
Regional	—		—	—
Messages	English, US		Yes	Yes
USB Keyboard	English, US		Yes	Yes
Locale	English, US		Yes	Yes
Unit	dot		Yes	Yes
Time	00:00		No	No
Date	(2000-01-01)		No	No
Time Zone	—		Yes	Yes
Region	Europe		Yes	Yes
City	London		Yes	Yes
Notifications	—		—	—
Clean Printhead	—		—	—
Clean Printhead	Disabled		Yes	Yes
Cleaning Interval	400 m		Yes	Yes
Change Printhead	—		—	—
Change Printhead	Disabled		Yes	Yes
Printhead Interval	100 km		Yes	Yes
Change Cutter	—		—	—
Change Cutter	Disabled		Yes	Yes
Cutter Life	1000 Kcuts		Yes	Yes
Change Platen	—		—	—
Change Platen	Disabled		Yes	Yes
Platen Interval	100 km		Yes	Yes
Sound	—		—	—
Error Sound	Medium		Yes	Yes
Energy Saving	—		—	—
Sleep Timeout	60 min		Yes	Yes
LCD Brightness	7		No	Yes
Show Total Count	Disabled		Yes	Yes
Password	—		—	—
Password Enable	Disabled		No	Yes
Install Security	Disabled		No	Yes

7 Appendix

Setting Item	Initial Value		User Reset	Factory Reset
	CL4NX	CL6NX		
NFC Security	None		Yes	Yes
Start on AC	Disabled		No	Yes

7.1.5 Tools Menu

Setting Item	Initial Value		User Reset	Factory Reset
	CL4NX	CL6NX		
Test Print	—		—	—
Factory	—		—	—
Label Width	Large		—	—
Pitch	0 dot		No	No
Offset	0 dot		No	No
Darkness Adjust	50		No	No
Configure List	—		—	—
Label Width	Small		—	—
Label Length	203 dpi: 800 dots 305 dpi: 1200 dots 609 dpi: 2400 dots	203 dpi: 800 dots 305 dpi: 1200 dots	Yes	Yes
Pitch	0 dot		No	No
Offset	0 dot		No	No
Darkness Adjust	50		No	No
Configure QR	—		—	—
Label Width	Small		—	—
Label Length	203 dpi: 800 dots 305 dpi: 1200 dots 609 dpi: 2400 dots	203 dpi: 800 dots 305 dpi: 1200 dots	Yes	Yes
Pitch	0 dot		No	No
Offset	0 dot		No	No
Darkness Adjust	50		No	No
Paper Sensor	—		—	—
Label Width	Small		—	—
Label Length	203 dpi: 800 dots 305 dpi: 1200 dots 609 dpi: 2400 dots	203 dpi: 800 dots 305 dpi: 1200 dots	Yes	Yes
Pitch	0 dot		No	No
Offset	0 dot		No	No
Darkness Adjust	50		No	No
HEX-Dump	—		—	—
Hex Dump Mode	Disabled		Yes	Yes
Reset	—		—	—

Setting Item	Initial Value		User Reset	Factory Reset
	CL4NX	CL6NX		
Profiles	—		—	—
Delete	—		—	—
Load	—		—	—
Save	—		—	—
Start with	—		Yes	Yes
Certificates	—		Yes/ Interface	Yes
Barcode Checker	—		—	—
Settings	—		—	—
Mode	Disabled		Yes	Yes
Start Position	203 dpi: 72 dots 305 dpi: 108 dots 609 dpi: 216 dots	203 dpi: 72 dots 305 dpi: 108 dots	Yes	Yes
VOID Print	Disabled		Yes	Yes
Retry Count	0		Yes	Yes
Host Notification	Disabled		Yes	Yes
Logs	—		—	—
Copy	—		—	—
Remove	—		—	—
Clone	Excl. LAN/Wi-Fi/IP		No	No
Startup Guide	Enabled		No	Yes

7.1.6 Information Menu

Setting Item	Initial Value		User Reset	Factory Reset
	CL4NX	CL6NX		
Help	—	—	—	—
Build Version	—	—	—	—
Applications	—	—	—	—
Installation Log	—	—	—	—
Print Module	—	—	—	—
Counters	—	—	—	—
Head	—	—	—	—
Life	Measured value		No	No
Head 1	Measured value		No	No
Head 2	Measured value		No	No
Head 3	Measured value		No	No
Cutter	0		No	No

7.2 Media Sensor Positions and Media Stop Positions

The media stop positions with the media sensor and various operation modes are as follows:

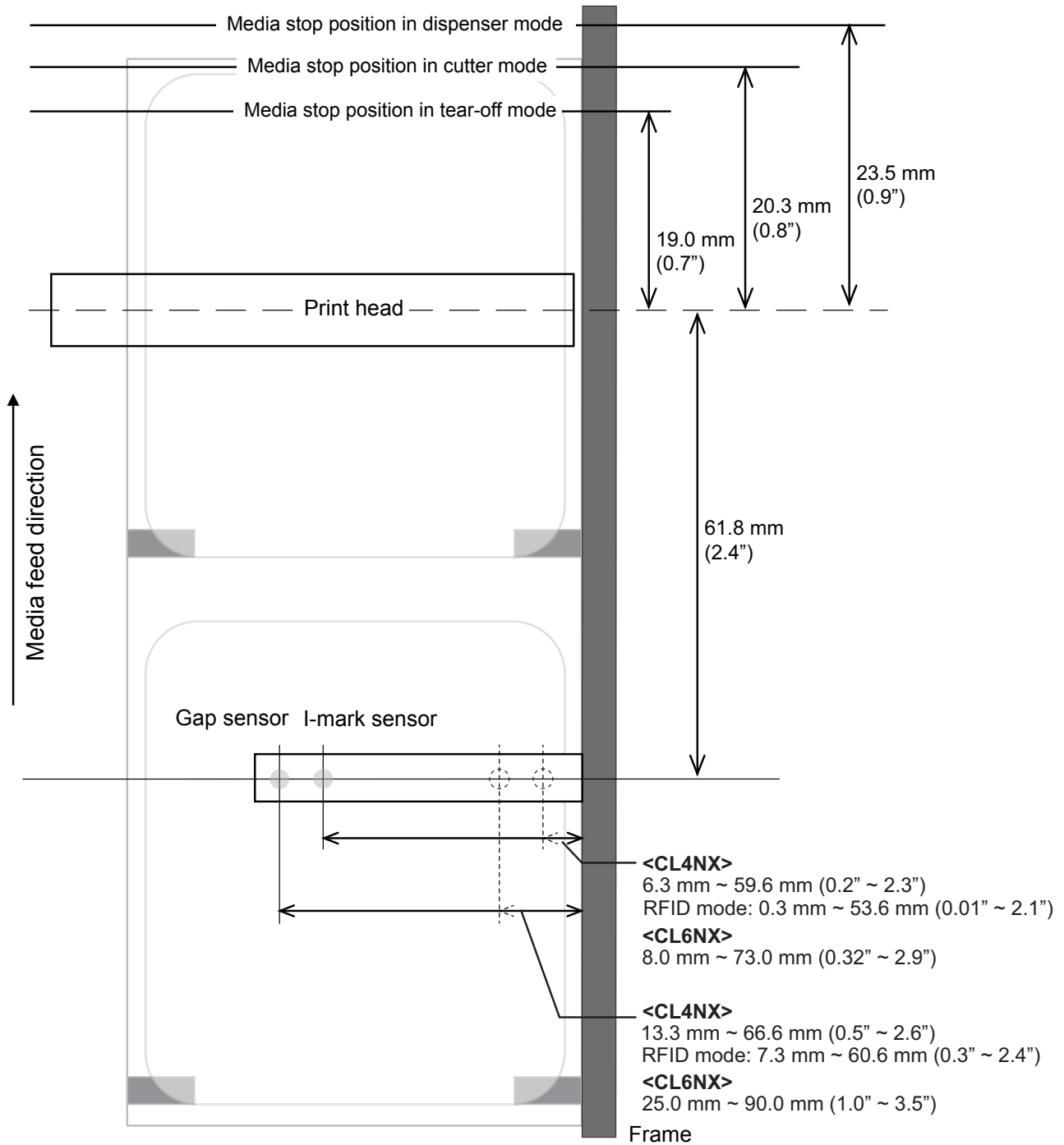

 CAUTION

For the CL4NX RFID model, the position of the I-mark sensor becomes a minimum of 0.3 mm (0.01") when the position of the gap sensor is adjusted to around 7.3 mm (0.3"). Because of this, the paper end may be frequently detected when **Paper End** in the **Printing > Advanced** menu is set to **Using I-mark** (the default), due to the shifting of the media or other causes. When you have adjusted the position of the Gap sensor to around 7.3 mm (0.3"), change **Paper End** to **Using Gap**.

7.3 Replacing the Print Head

You can easily remove and replace a damaged or worn print head.

WARNING

- Do not touch the power button, connect or disconnect the power cord while your hands are wet. Doing so could cause an electric shock.
- Disconnect the power cord from the AC outlet before you replace the print head.
- Wear gloves before replacing the print head, to prevent damage to the print head.

1 Make sure that the printer is in power off mode, then disconnect the power cord from the AC outlet.

2 Open the top cover.

CAUTION

Open the top cover fully to prevent accidental drop of the cover.

3 Push the **head lock lever** ① towards the rear to unlock the **print head**.

CAUTION

- The print head and its surroundings are hot after printing. Be careful not to touch it, to avoid being burned.
- Touching the edge of the print head with your bare hand could cause injury.

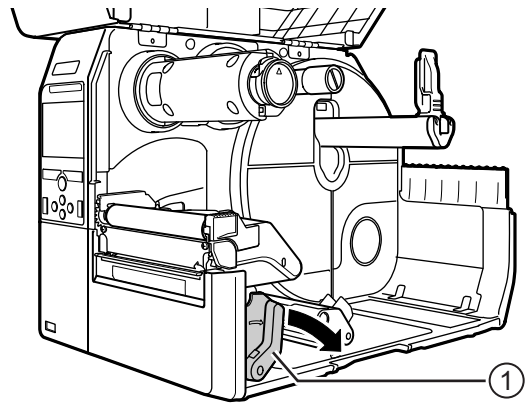

4 Remove the media and ribbon if they are already loaded.

Refer to [Section 3.3 Removing the Ribbon](#) and the reverse procedure in [Section 3.5 Loading Media](#).

5 Press the **lever** ② to remove the **print head** ③.

⚠ CAUTION (for CL4NX only)

For UHF RFID models, the UHF RFID antenna is installed on the print head. Be careful not to overly pull the antenna cable when replacing the print head. Contact your SATO reseller or technical support center for more information.

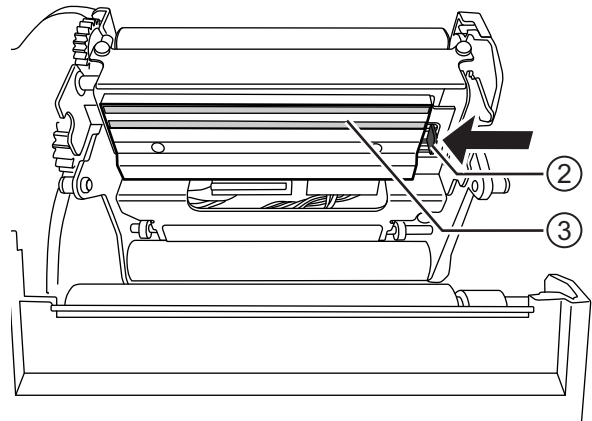

6 Disconnect all the **connectors** ④ from the defective **print head** ③.

In total, there are two connectors for CL4NX and three connectors for CL6NX.

7 Connect all the **connectors** ④ to the new **print head**.

⚠ CAUTION

Handle the print head with care. Do not contaminate or scratch the sensitive print head surface.

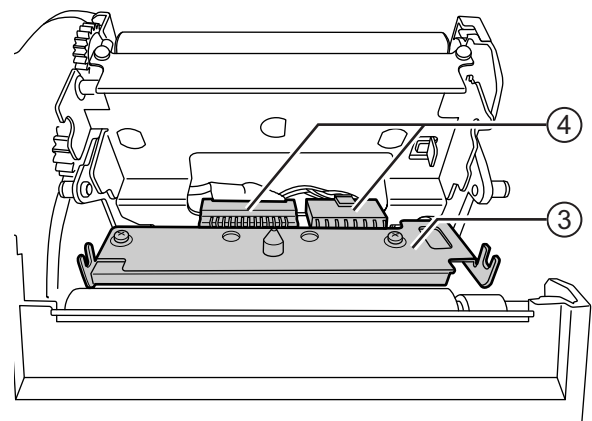

8 Install the new **print head**.

Install the print head so that it is locked with a click sound.

9 Load the media and ribbon back if you remove them in step 4.

Refer to [Section 3.5 Loading Media](#) and [Section 3.2 Loading the Ribbon](#).

7.4 Replacing the Platen Roller

You can easily remove and replace a damaged or worn platen roller.

WARNING

- Do not touch the power button, connect or disconnect the power cord while your hands are wet. Doing so could cause an electric shock.
- Disconnect the power cord from the AC outlet before you replace the platen roller.

1 Make sure that the printer is in power off mode, then disconnect the power cord from the AC outlet.

2 Open the top cover.

CAUTION

Open the top cover fully to prevent accidental drop of the cover.

3 Push the **head lock lever** ① towards the rear to unlock the **print head**.

CAUTION

- The print head and its surroundings are hot after printing. Be careful not to touch it, to avoid being burned.
- Touching the edge of the print head with your bare hand could cause injury.

4 Lift the **lever** ② in the direction ① to unlock the **platen roller** ③, then pull out the **platen roller** ③ in the direction ②.

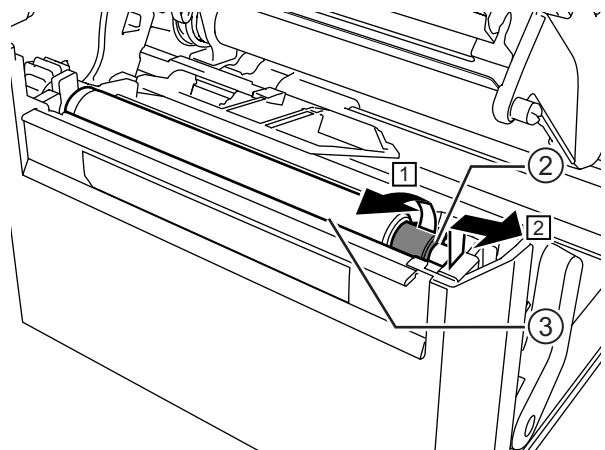
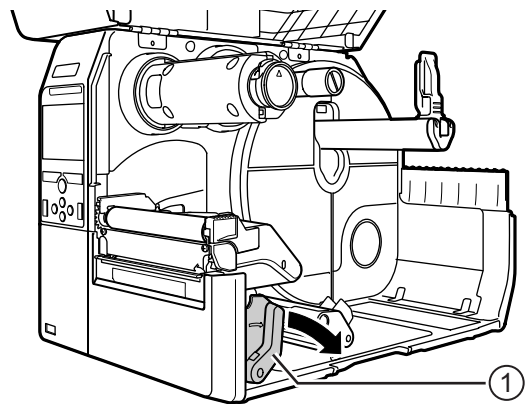

5 Install the new platen roller. Make sure that the first **tab** ④ on the driving end of the platen roller is pointing upward. Then push the platen roller in the direction ③ so that the first **tab** ④ is fixed in the **groove** ⑤ at the driving side.

6 Next, make sure that the second **tab** ⑥ on the driven end of the platen roller is pointing upward. And then push the platen roller again in the direction ③ so that the second **tab** ⑥ is fixed in the **groove** ⑦ at the driven side.

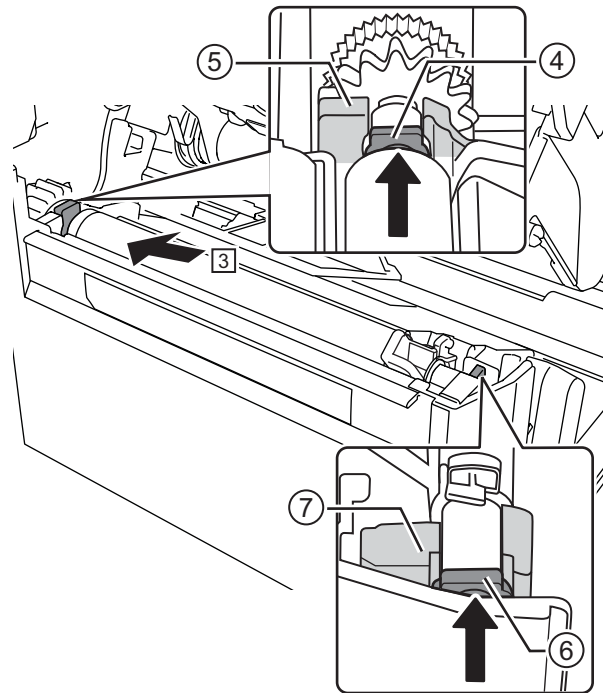

7 Turn the **lever** ② back to lock the platen roller.



7.4.1 Guideline to Replace the Linerless Platen Roller (CL4NX only)

The linerless platen roller has a blue striped marking on the left side. When the blue striped marking started to fade off, it indicates that you should replace the linerless platen roller.

This is only a general guideline, the condition of the platen roller wears out varies depending on the used media. In any cases, replace the worn platen roller when it affected the printing quality of the printer.

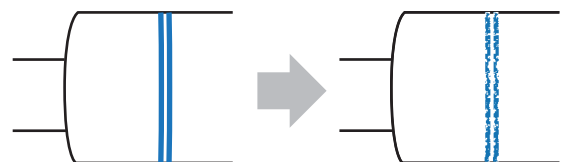



7.5 Optional RFID Configuration (CL4NX only)



This chapter explains the procedures on how to configure the printer to encode your inlays.

- 1 Examine the media to determine the printer settings.
Refer to the **CL4NX Inlay Configuration Guide*** for the measurements you should take and what they mean, as well as a list of inlays and their required configurations.



* To see the CL4NX Inlay Configuration Guide, access the following URL:
<http://www.satoworldwide.com/rfid/>

- 2 Press the  power button on the operator panel until the LED lights up in blue to power on the printer.
- 3 When the printer is in online mode, press the  button on the operator panel to change to offline mode.
- 4 Press the  button to show the **Settings** menu.

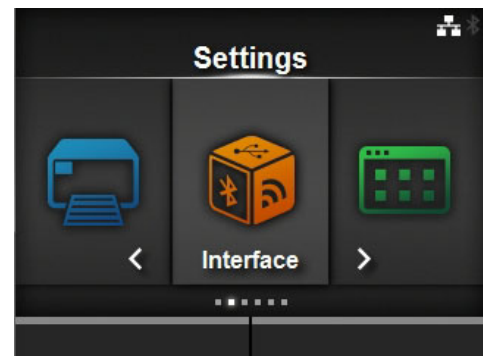

- 5 Press the  /  buttons to select **Interface** and then press the  button.



- 6 Press the  /  buttons to select **RFID** and then press the  button.

The RFID screen shows.

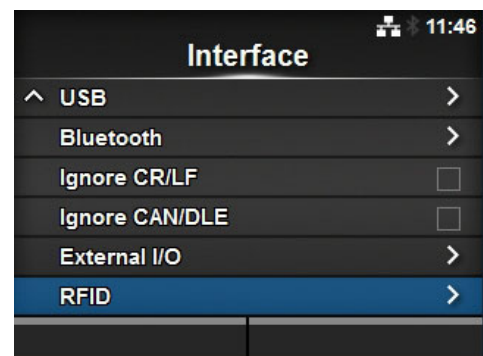

7 Press the ▲/▼ buttons to select the item you want to set. Then press the ← button to go to the adjustment screen.

Refer to **Interface > RFID (CL4NX only)** menu of **Section 4.3 Settings Menu Tree Structure** for details on the configuration items.

RFID	
Antenna Pitch	Standard
Write Power	10 dBm
Read Power	10 dBm
Tag Offset	0 mm
Reader Model	UHF:M6e Micro
Reader Version	01.01.00.EA

8 Open the top cover ①.

CAUTION

Open the top cover fully to prevent accidental drop of the cover.

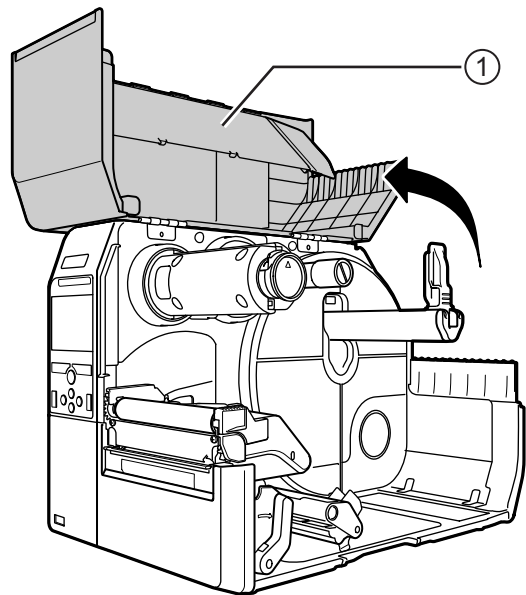

9 Push the head lock lever ② towards the rear to unlock the print head.

CAUTION

- The print head and its surroundings are hot after printing. Be careful not to touch it, to avoid being burned.
- Touching the edge of the print head with your bare hand could cause injury.

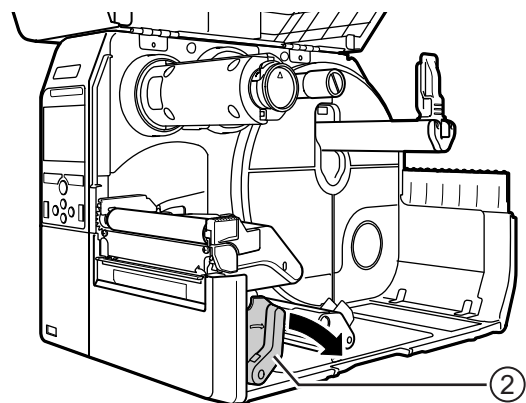

10 Adjust the position of the RFID antenna. Rotate the **dial** ③ to align the **pointer** ④ with the media being used.

When the **Antenna Pitch** is set to **Standard** in the **Interface > RFID** menu, adjust the physical position of the antenna according to the settings required for the specific media and inlay used. Refer to the “**Antenna Position**” of the **Inlay Placement & Configuration Table** in the **CL4NX Inlay Configuration Guide***.

* To see the CL4NX Inlay Configuration Guide, access the following URL:
<http://www.satoworldwide.com/rfid/>

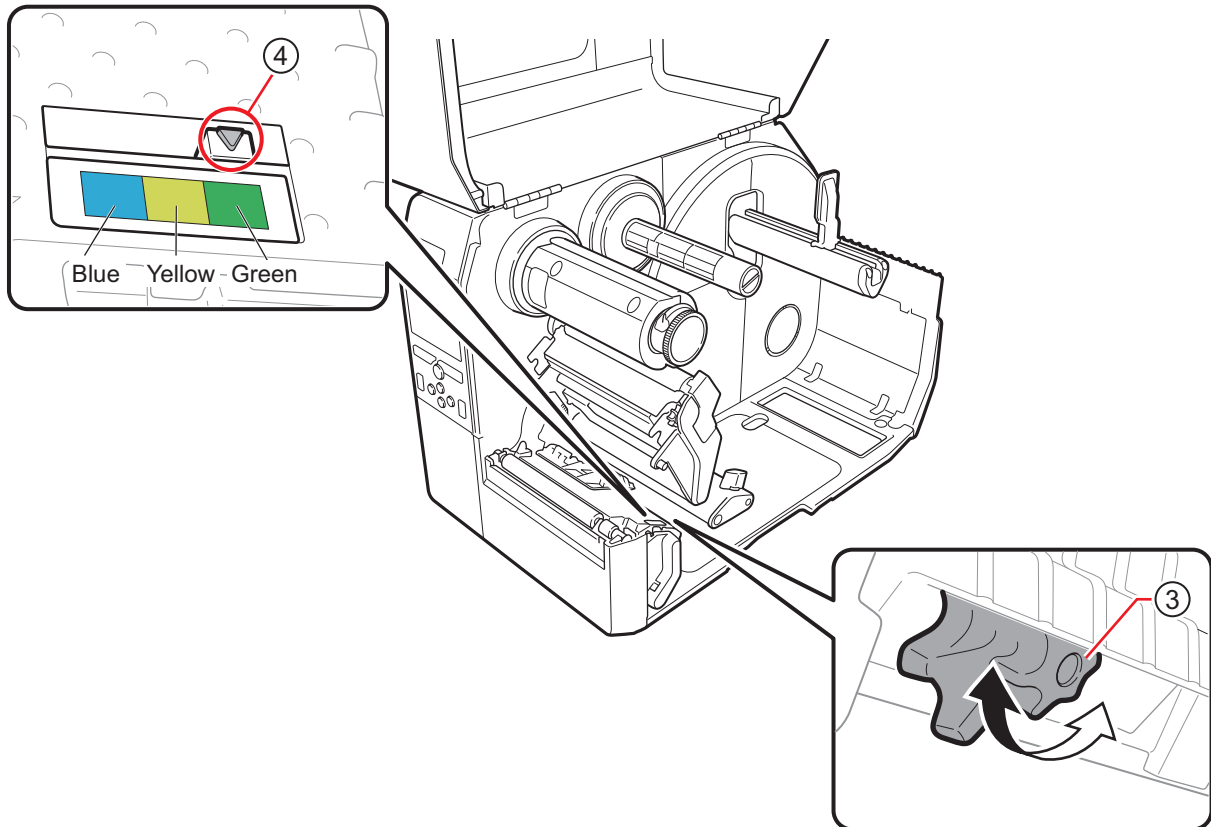

11 Load the media and ribbon.

Refer to **Section 3.2 Loading the Ribbon** and **Section 3.5 Loading Media** for details.

12 Confirm the operation by printing/encoding a media.

Make sure that you read the data and check that it is correctly encoded.

7.5.1 Printing RFID Tag Errors

If the recorded data on a tag is incomplete due to writing on a defective tag, the printer will print an RFID tag error to the defective media. This function is to prevent the distribution of defective media with a tag error.

When an RFID tag error occurs, the printer prints a slash and the error message, such as “WRITE TAG ERROR” or “TAG NOT FOUND”. The position to print the message and slash is set using the specified media size command <A1>.

For a write error such as “WRITE TAG ERROR”, the printer continues to print the first sixteen or thirty-two bytes of the write data.

The diagram below shows the message and slash printed on the position based on the media size specified by the normal print.

WRITE TAG ERROR in RFID write command

For other errors, the printer prints the error message accordingly.

Read error in UID/EPC/IDm print command <TU> or TAG NOT FOUND error

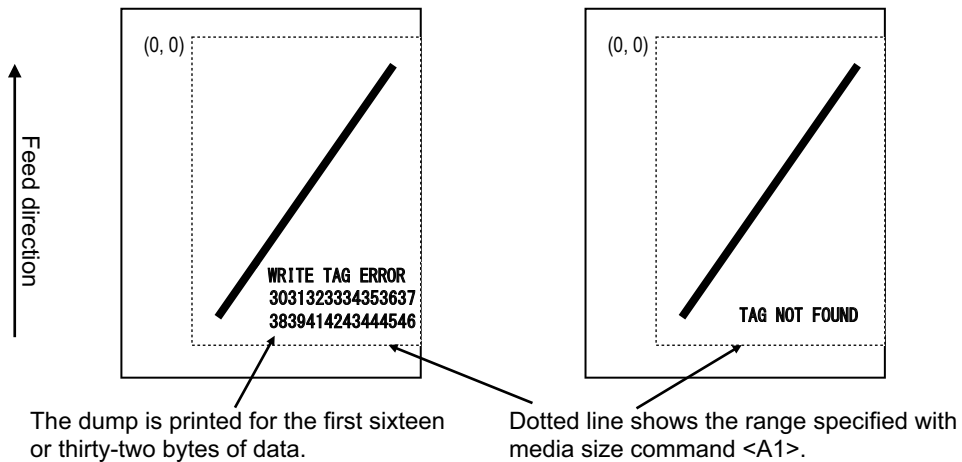

TAG NOT FOUND error in RFID write command

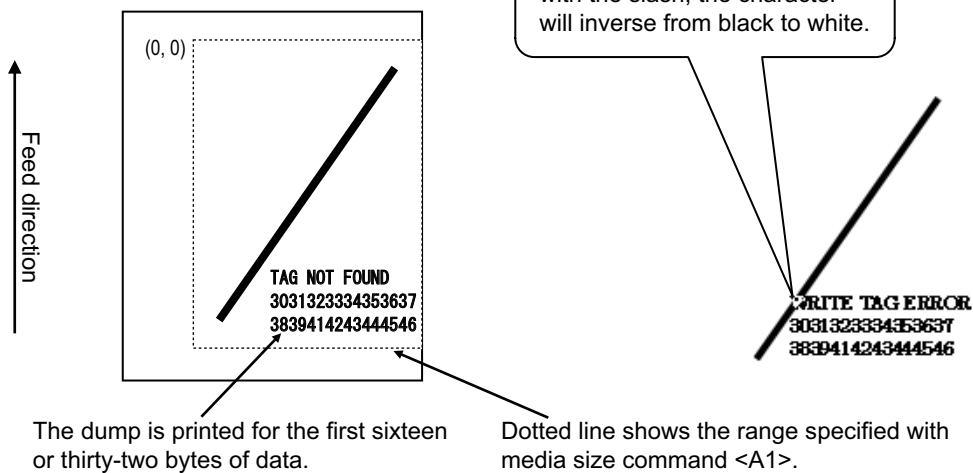

*(0,0): The origin of the range specified by the media size command <A1>

When using a small-size label (about the size of P30 X W40 mm, for example) or not enough for setting margin, the slash and error message are printed overlap on each other. The overlapped area are inverse from black to white. There is no dump printing.

TAG NOT FOUND error in RFID write command

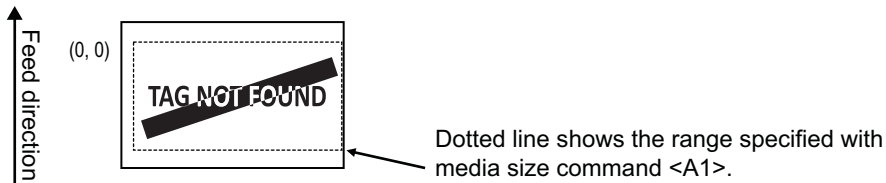

If not specified by the media size command <A1>, the printer prints the RFID error using a fixed size of P30 X W40 mm. When a character overlaps with the slash, the character will inverse from black to white.

WRITE TAG ERROR in RFID write command

For other errors, the printer prints the error message accordingly.

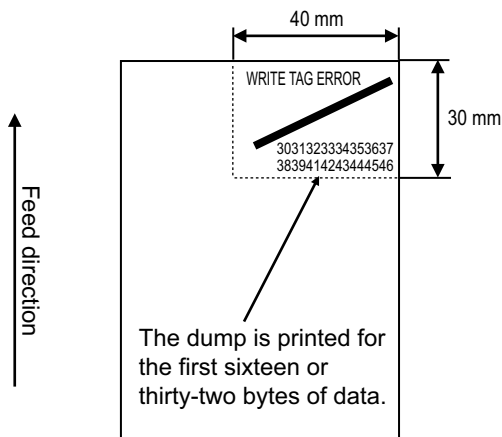

Read error in UID/EPC/IDm print command <TU> or TAG NOT FOUND error

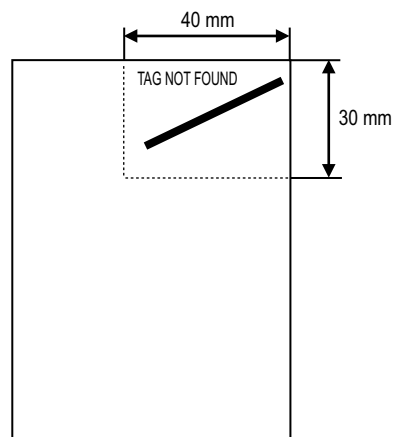

TAG NOT FOUND error in RFID write command

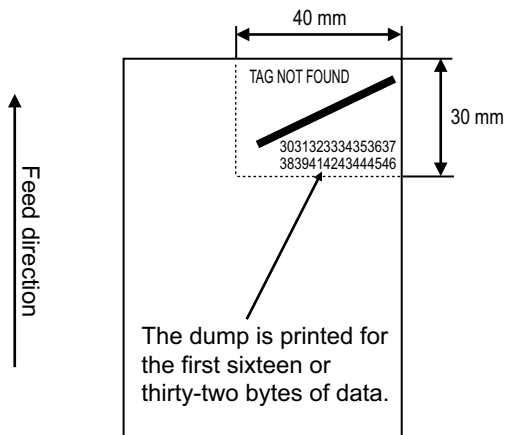

The types of errors to print are as follows:

Message	Cause and Countermeasure	
TAG NOT FOUND	Cause:	Did not find the tag to print, or failed to read the tag.
	Countermeasure:	Confirm the inlay operation and check the printer/antenna configuration.
WRITE TAG ERROR	Cause:	Failed to write the tag.
	Countermeasure:	Confirm the inlay operation and check the printer/antenna configuration.
PROTECT (TAG) ERROR	Cause:	1. Tried to write to a locked tag. 2. Tried to write to an address that is not permitted.
	Countermeasure:	Use media that is not locked.
VERIFY TAG ERR(OR)	• Only for ISO/IEC 15693, ISO/IEC 14443 Type A	
	Cause:	The written data and read data do not match.
	Countermeasure:	Confirm the inlay operation and check the printer/antenna configuration.
	• Only for FeliCa	
	Cause:	The written data and read data do not match. A value greater than original data was written to subtraction register.
	Countermeasure:	Write an appropriate value to subtraction register.
LOCKING ERROR	Cause:	Failed to lock the tag.
	Countermeasure:	Check the media.
WRONG TID ERROR	• Only for ISO/IEC 15693	
	Cause:	Read the UID of the tag other than the specified tag.
	Countermeasure:	Check the tag type setting and the label.
MULTI TAGS ERROR	• Only for ISO/IEC 15693, ISO/IEC 14443 Type A	
	Cause:	Multiple tags detected at a time.
	Countermeasure:	Confirm the inlay operation and check the printer/antenna configuration.
	• Only for FeliCa	
	Cause:	The captured IDm of the card is inconsistent between processes. (Tried to write to a wrong card.)
	Countermeasure:	Confirm the inlay operation and check the printer/antenna configuration.
DIFFER EPC ERROR	• Only for UHF	
	Cause:	Detected inconsistent EPC during a series of processes.
	Countermeasure:	Check the media.

Message	Cause and Countermeasure	
CHIP MAKER ERR.	• Only for UHF	
	Cause:	Incorrect tag chip maker is specified when specifying the MCS setting and encoding the SGTIN96.
	Countermeasure:	Check the media, and correct the tag chip maker.
MCS NOT SUPPORT	• Only for UHF	
	Cause:	Unsupported inlay (IC chip) is used when specifying the MCS setting and encoding the SGTIN96.
	Countermeasure:	Check the media, and change it to supported inlay.
READ ONLY ERROR	• Only for UHF	
	Cause:	1. Tried to write to a write-locked tag. 2. Tried to write to a tag when the write power is low.
	Countermeasure:	1. Use media that is not locked. 2. Adjust Write Power/Read Power .
DIFFER TAG KIND	• Only for ISO/IEC 15693, ISO/IEC 14443 Type A, FeliCa	
	Cause:	Incorrect tag type is specified.
	Countermeasure:	Check the tag type, and specify the correct tag type.
LOST HANDLE ERR	• Only for ISO/IEC 15693, ISO/IEC 14443 Type A, FeliCa	
	Cause:	Failed to acquire the ID.
	Countermeasure:	The radio wave condition needs to be improved. Increase the Read Power level.

7.5.2 RFID Error and Reset Timing

Error signal output with one-shot pulse

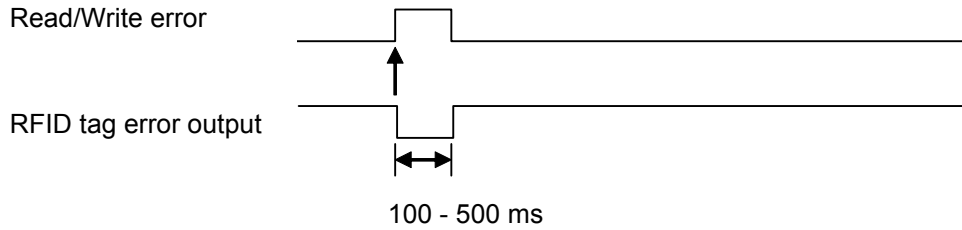

Error signal output with long pulse

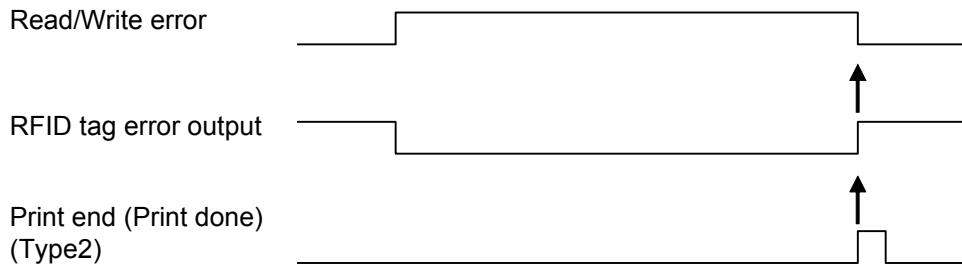

When the reprint count reaches the specified number, the RFID tag error and Machine error are outputted at a time. The machine error output is always a long pulse.

Timing chart of error signal output with one-shot pulse

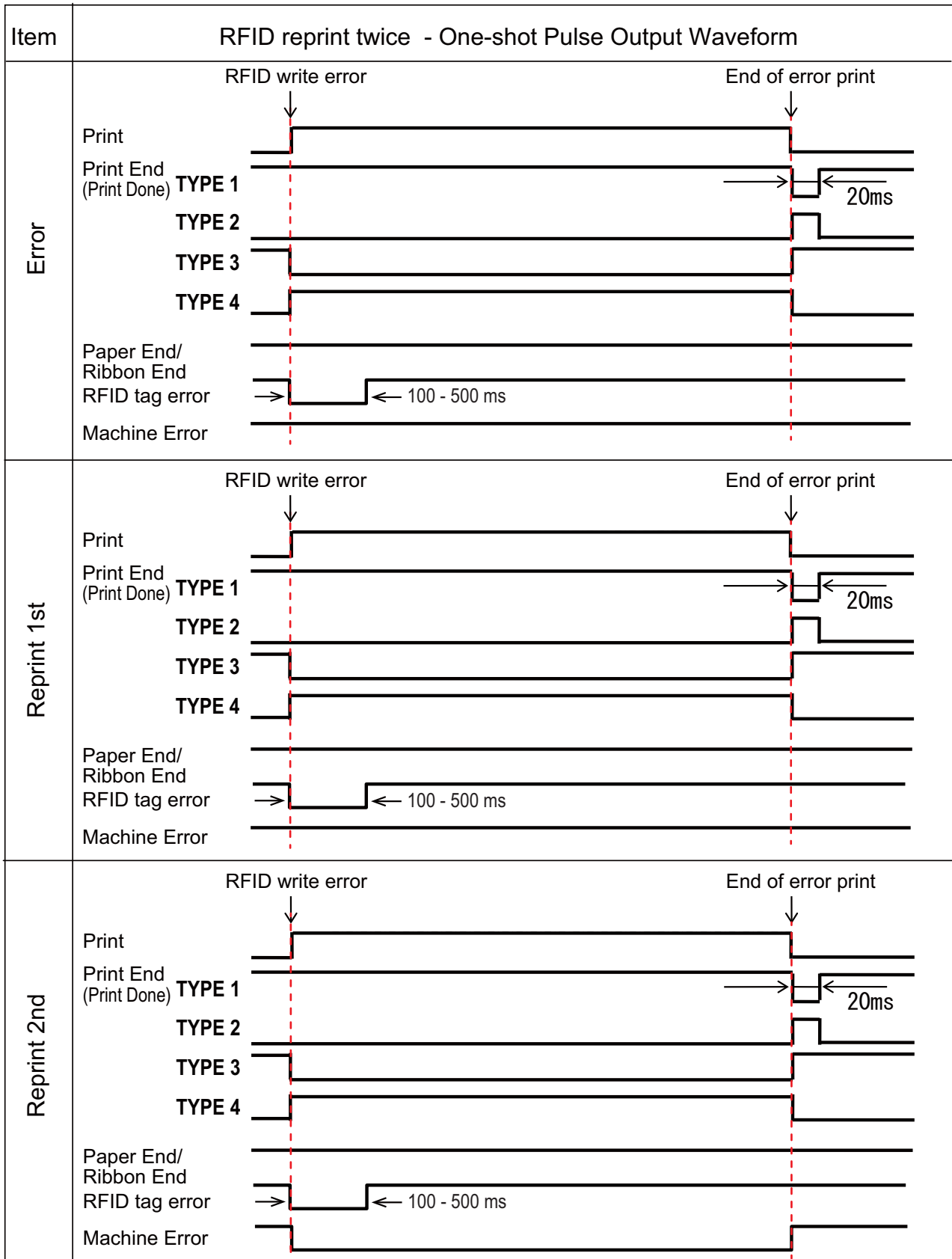

Timing chart of error signal output with long pulse

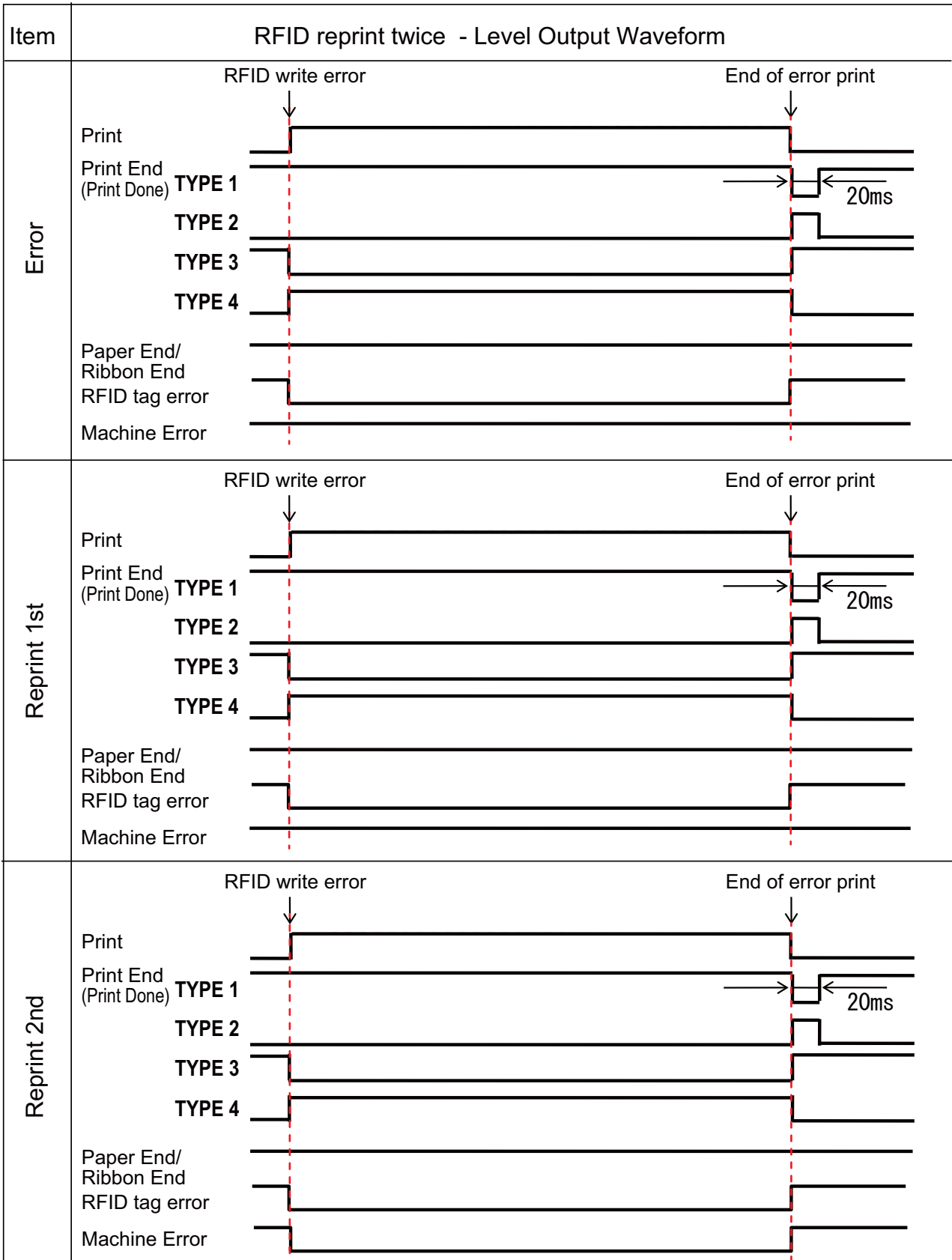

7.5.3 External (EXT) Signal Interfaces when RFID Mode is Enabled

Comparison of EXT signal between RFID Mode is disabled or enabled.

RFID Mode disabled.

Pin No.	Signal	I/O
1	Paper End	Output
2	Ground	-
3	Ribbon End	Output
4	Machine Error	Output
5	Print Start (PRIN)	Input
6	Print Done/End (PREND)	Output
7	Reprint (PRIN2)	Input
8	External Power Supply	Input
9	Online	Output
10	Ribbon Near End	Output
11	N/A	-
12	+24V	Output
13	+5V	Output
14	Frame Ground	-

RFID Mode enabled.

Pin No.	Signal	I/O
1	Paper End + Ribbon End	Output
2	Ground	-
3	RFID Tag Error	Output
4	Machine Error/RFID Error	Output
5	Print Start (PRIN)	Input
6	Print Done/End (PREND)	Output
7	Reprint (PRIN2)	Input
8	External Power Supply	Input
9	Online	Output
10	Ribbon Near End	Output
11	N/A	-
12	+24V	Output
13	+5V	Output
14	Frame Ground	-

Standard specification is applied when the RFID Mode is set to Disabled. Functions shown by shading are applied when the RFID Mode is set to Enabled.

7.5.4 RFID Printing Tips

Recommended non-printable zone

Avoid printing barcodes or characters directly on top of an RFID chip. The uneven surface will negatively affect the print quality.

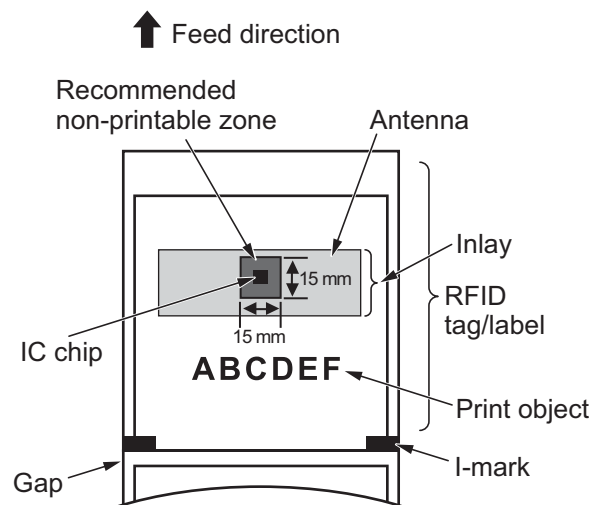

7.6 Optional Barcode Check Function Configuration

7.6.1 Basic Specifications of the Barcode Check Function

The barcode check function does a reading check of a barcode printed by this printer to prevent the distribution of labels with defective barcodes. You can use this function by installing the supported barcode checkers to the printer.

The basic specifications of the barcode check function are as follows:

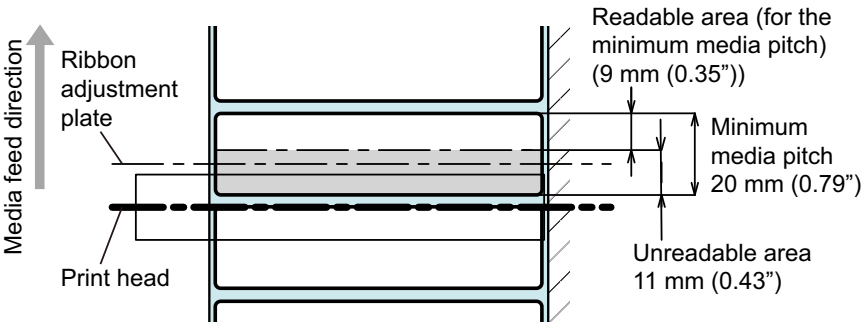
Item	Specification
Supported Barcode Checkers	<ul style="list-style-type: none"> • IDEC/DATALOGIC WB1F-100S1S (for 1D barcodes, USB connection) • IDEC/DATALOGIC GFS4470 (for 1D barcodes/2D codes, USB connection) • KEYENCE BL-1301 (for 1D barcodes, RS-232C connection) • KEYENCE SR-710 (for 1D barcodes/2D codes, RS-232C connection)
Supported Commands	SBPL/SZPL/SIPL/STCL/SDPL/SEPL *AEP is not supported.
Supported Print Modes	Continuous/Cutter/Cut & Print/Dispenser/Linerless (CL4NX only) *Not available in Tear-Off mode. *Not available for CL4NX RFID models. *The Void Print function is not available in Dispenser/Linerless (CL4NX only) mode.
Print Speed/ Print Darkness	The optimal print speed and print darkness for secure reading vary depending on various conditions, such as the barcode type and label layout. Be sure to perform a test read carefully and determine the settings.
Printable Area (Barcode Readable Area)	<p>Same as the printer specifications. However, there are following restrictions:</p> <p>Continuous mode: Barcodes printed within the range of 11 mm (0.43") from the trailing end of the label cannot be read because it is blocked by the print head and ribbon adjustment plate.</p> 

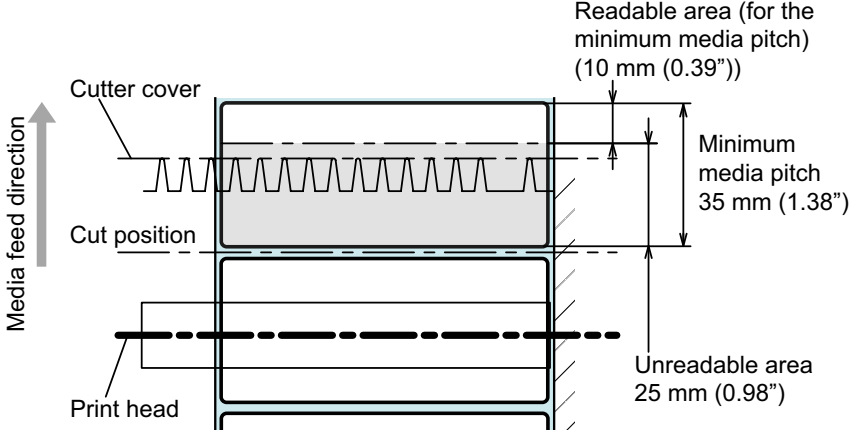
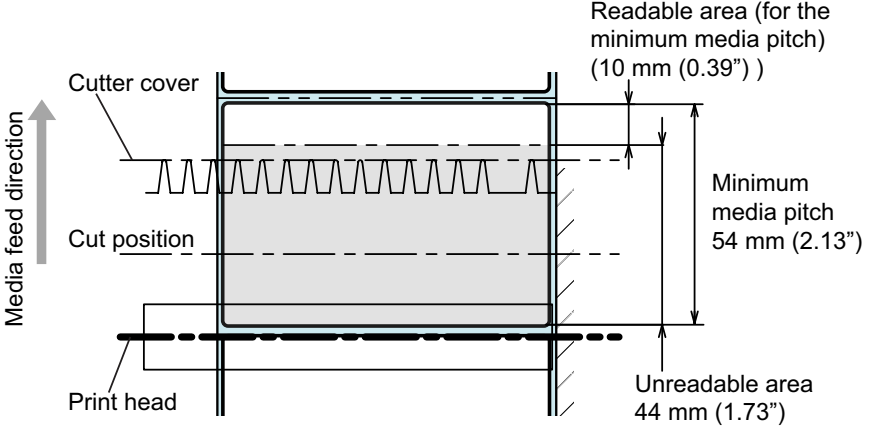
Item	Specification
<p>Printable Area (Barcode Readable Area)</p>	<p>Cutter/Cut & Print mode: Barcodes printed within the following area cannot be read because it is blocked by the cutter cover.</p> <ul style="list-style-type: none"> • Cutter (cutting every label): 25 mm (0.98") from the trailing end of the label  <p>The diagram shows a cross-section of the printer's media path. A vertical arrow on the left indicates the 'Media feed direction' pointing upwards. A 'Cutter cover' is shown at the top, with a sawtooth edge. Below it is the 'Cut position' indicated by a dashed line. At the bottom is the 'Print head' with a dashed line representing the print area. The media is shown with a series of vertical bars representing barcodes. Dimensions on the right side indicate: a 'Readable area (for the minimum media pitch)' of 10 mm (0.39"), a 'Minimum media pitch' of 35 mm (1.38"), and an 'Unreadable area' of 25 mm (0.98") at the trailing end.</p> <ul style="list-style-type: none"> • Cutter (cutting according to the specified number of labels)/ Cut & Print: 44 mm (1.73") from the trailing end of the label  <p>The diagram shows a similar cross-section of the printer's media path. A vertical arrow on the left indicates the 'Media feed direction' pointing upwards. A 'Cutter cover' is shown at the top, with a sawtooth edge. Below it is the 'Cut position' indicated by a dashed line. At the bottom is the 'Print head' with a dashed line representing the print area. The media is shown with a series of vertical bars representing barcodes. Dimensions on the right side indicate: a 'Readable area (for the minimum media pitch)' of 10 mm (0.39"), a 'Minimum media pitch' of 54 mm (2.13"), and an 'Unreadable area' of 44 mm (1.73") at the trailing end.</p>

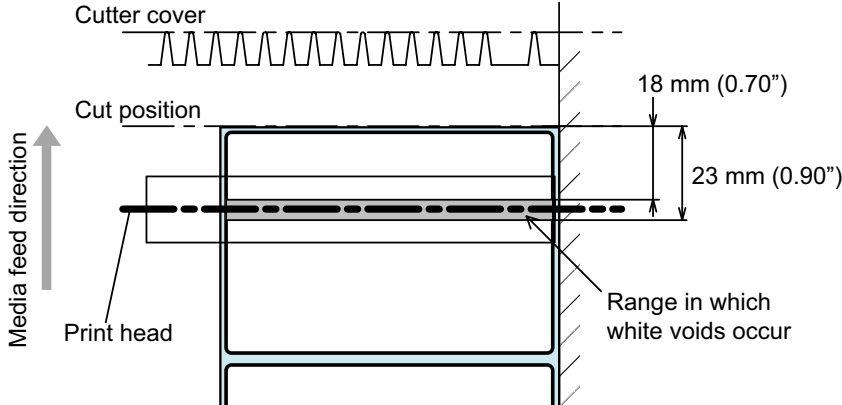
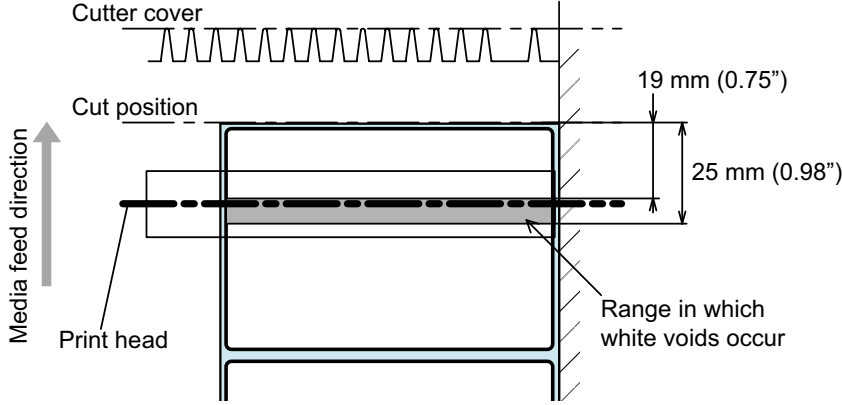
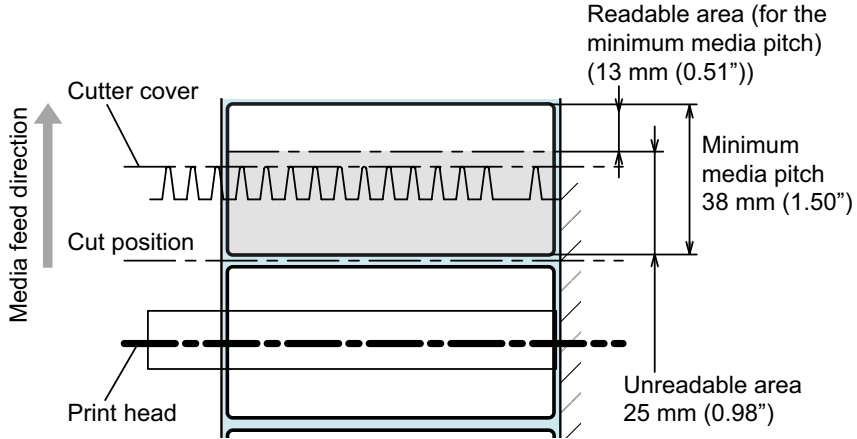
Item	Specification
<p>Printable Area (Barcode Readable Area)</p>	<p>Cut & Print mode: Do not print a 2D code or serial barcode (90° or 180° orientation in relation to the media feed direction) within the following area as it may cause a white void.</p> <ul style="list-style-type: none"> CL4NX: 18 to 23 mm (0.70" to 0.90") from the front end of the label (cut position)  <ul style="list-style-type: none"> CL6NX: 19 to 25 mm (0.75" to 0.98") from the front end of the label (cut position)  <p>Linerless mode (CL4NX only): Barcodes printed within a range of 25 mm (0.98") from the trailing end of the label cannot be read as it is blocked by the cutter cover.</p> 

Item		Specification
Usable Media Sizes	Media width	Same as the printer specifications.
	Media Pitch	<p>The minimum size is different from the printer specifications.</p> <p>Continuous mode:</p> <ul style="list-style-type: none"> • 203 dpi: 20 to 2497 mm (0.79" to 98.30") (with liner: 23 to 2500 mm (0.90" to 98.42")) • 305 dpi: 20 to 1497 mm (0.79" to 58.94") (with liner: 23 to 1500 mm (0.90" to 59.05")) • 609 dpi (CL4NX only): 20 to 397 mm (0.79" to 15.63") (with liner: 23 to 400 mm (0.90" to 15.75")) <p>Cutter mode (cutting every label):</p> <ul style="list-style-type: none"> • 203 dpi: 35 to 2497 mm (1.38" to 98.30") (with liner: 38 to 2500 mm (1.50" to 98.42")) • 305 dpi: 35 to 1497 mm (1.38" to 58.94") (with liner: 38 to 1500 mm (1.50" to 59.05")) • 609 dpi (CL4NX only): 35 to 397 mm (1.38" to 15.63") (with liner: 38 to 400 mm (1.50" to 15.75")) <p>Cutter (cutting according to the specified number of labels)/Cut & Print mode:</p> <ul style="list-style-type: none"> • 203 dpi: 54 to 2497 mm (2.13" to 98.30") (with liner: 57 to 2500 mm (2.24" to 98.42")) • 305 dpi: 54 to 1497 mm (2.13" to 58.94") (with liner: 57 to 1500 mm (2.24" to 59.05")) • 609 dpi (CL4NX only): 54 to 397 mm (2.13" to 15.63") (with liner: 57 to 400 mm (2.24" to 15.75")) <p>Dispenser mode:</p> <ul style="list-style-type: none"> • 27 to 397 mm (1.06" to 15.63") (with liner: 30 to 400 mm (1.18" to 15.75")) <p>Linerless mode (CL4NX only):</p> <ul style="list-style-type: none"> • 38 to 120 mm (1.50" to 4.72")
Usable Media Types		Same as the printer specifications. If the label color is silver or laminated, however, it makes it difficult for the barcode checker to read the barcode, as the light of the barcode checker may cause a reflection on the label surface. Be sure to do a test read carefully in advance.

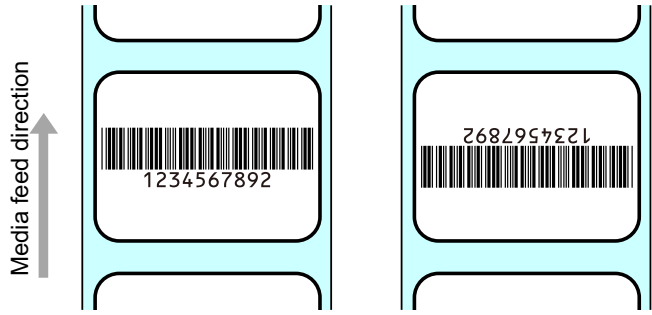
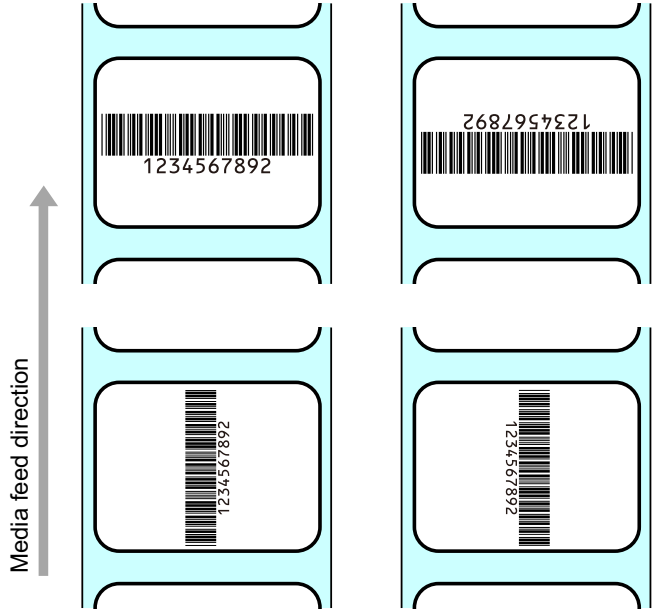
Item	Specification	
Readable Barcode Orientations	1D Barcode Checker	
	2D Code Checker	 <p data-bbox="435 1323 1358 1384">Place the barcode within the size of the visual field. Do a test read carefully in advance.</p>
Recommended Barcode Sizes	1D Barcode	<p>Narrow bar: 0.25 mm (0.01") or greater</p> <ul style="list-style-type: none"> • 203 dpi: 2 dots or more • 305 dpi: 3 dots or more • 609 dpi (CL4NX only): 6 dots or more <p>Refer to the specifications of each barcode checker.</p>
	2D Code	<p>Cell size: 0.25 mm (0.01") or greater</p> <ul style="list-style-type: none"> • 203 dpi: 2 dots or more • 305 dpi: 3 dots or more • 609 dpi (CL4NX only): 6 dots or more <p>Refer to the specifications of each barcode checker. The size of the visual field conforms to the specifications of the barcode checker.</p>

Available Code Formats

The barcode check function supports the following code formats. Check the specifications of the barcode checker to ensure compatibility with the available code types.

Code type	Available code formats
1D Barcodes	CODABAR(NW-7) CODE39, CODE93, CODE128 JAN/EAN-13/8 UPC-A/UPC-E ITF Industrial 2 of 5 Matrix 2 of 5 MSI GS1-128 POSTNET IMB (USPS) GS1 DataBar Omnidirectional GS1 DataBar Truncated GS1 DataBar Limited GS1 DataBar Expanded GS1 DataBar Stacked GS1 DataBar Stacked Omnidirectional GS1 DataBar Expanded Stacked
2D Codes	PDF417 Micro PDF417 Maxi Code QR Code Micro QR Code Data Matrix Aztec Code
Combined Symbols	JAN/EAN-13/8(CC-A/CC-B) UPC-A/UPC-E(CC-A/CC-B) GS1-128(CC-A/CC-B/CC-C) GS1 DataBar(CC-A/CC-B)

CAUTION

Use barcode fonts to create a barcode. If a barcode created as an image (such as BMP) is placed within the barcode readable area, the readable mode and comparison mode of the barcode check function may not function correctly.

7.6.2 Setting Up the Barcode Checker

To use the barcode check function, perform necessary operational settings for the supported barcode checker and then install it to the printer.

Operational Settings for the Barcode Checker

Set up the barcode checker either by using the application software provided by its manufacturer or by reading the barcodes for setting changes printed on the barcode checker's manual. For details, refer to the manual.

Settings common to all supported barcode checkers

Limit the barcode types you permit the barcode checker to read as much as possible. If a lot of barcode types are permitted, a longer decode time is required. This can cause the barcode checker to fail to read the printed barcode.

GFS4470

- Select USB-COM. The printer cannot detect the barcode checker when connected with other settings.
- To shorten laser lighting time, it is recommended to set the reading mode to "On Line" or "Serial On Line".
- If multiple barcodes are captured at once when using the default barcode checker settings, only the first set of decoded barcode data is sent. You can change the settings to decode and send all the captured barcodes. However, if this is done, combined symbols cannot be read.
- When printing barcodes in a narrow range, allow enough time for decoding (parameter: DETM), otherwise not all of the results of the decoded captured barcodes will be sent.
- Because postal barcodes consist of bars and spaces with equal intervals, they may be read as a different barcode type. When checking postal barcodes, it is recommended to set other barcode types to be unreadable.

KEYENCE barcode checkers (BL-1301, SR-710)

Set the barcode checker's interface settings to either (1) or (2).

If the barcode checker set to (1) is connected, the printer will change the settings to (2).

Settings	(1)	(2)
Baud rate	9600 bps	115200 bps
Data length	7 bits	8 bits
Parity	Even	Even
Stop bit length	1 bit	1 bit

Barcode Checker Installation







Mount the barcode checker to the optional barcode checker stand kit and connect it to the printer. For details on how to install the barcode checker, refer to the Barcode Checker Stand Kit Installation Manual that came with the barcode checker stand kit.

Note

- Because the KEYENCE barcode checkers (BL-1301, SR-710) use an RS-232C connection, an optional scanner connection cable is required.
- When replacing media or ribbon, remove the barcode checker stand kit from the printer. When doing this, first turn the switch of the magnetic base stand to OFF and remove the barcode checker stand. For details on how to use the barcode checker stand, refer to the Barcode Checker Stand Kit Installation Manual.

7.6.3 Changing How the RS-232C Interface is Used (When Using the KEYENCE Barcode Checkers)

When using one of the KEYENCE barcode checkers (BL-1301, SR-710), modify the barcode checker's operational settings so that it can communicate with the printer, and then connect it to the printer. After connecting the barcode checker to the printer, change the **Interface** setting of the RS-232C interface to **RS-232C Reader** on the printer. With this setting, the printer can detect the barcode checker and automatically connect with it according to the barcode checker's interface settings.

- 1 After connecting the barcode checker, press the  power button on the operator panel until the LED lights up in blue to power on the printer.
- 2 When the printer is in online mode, press the  button on the operator panel to change to offline mode.
- 3 Press the  button to show the **Settings** menu.
- 4 Press the  buttons to select **Interface**, and then press the  button.
- 5 Press the  buttons to select **RS-232C > Interface**, and then press the  button.

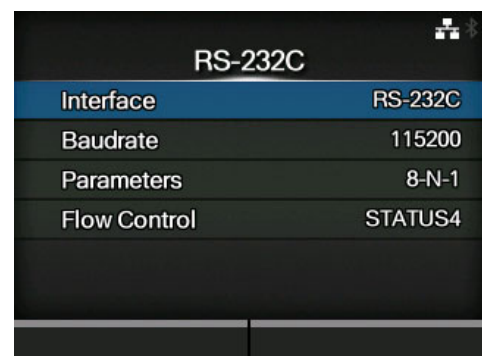
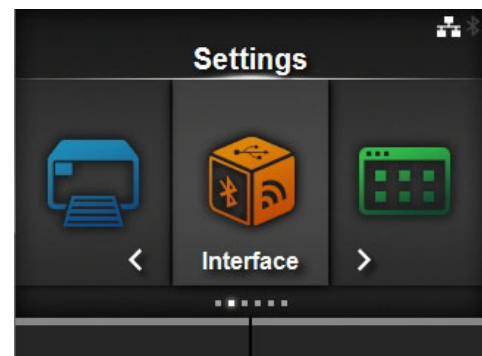

- 6** Press the ▲/▼ buttons to select **RS-232C Reader**.

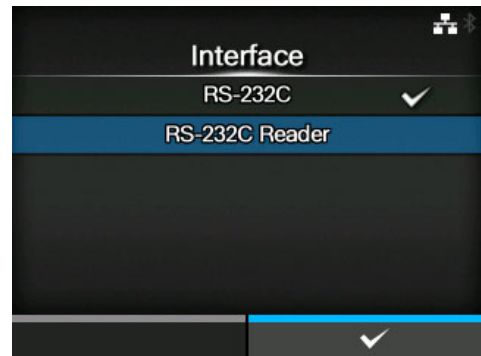

- 7** Press the right soft button to save the setting value.
- 8** Press the ►|| button to change to offline mode.
- 9** Power the printer off, and then on again.
When the printer is powered on, the barcode checker is also powered on automatically.

CAUTION

When the barcode checker is powered on, it emits a laser light for a few seconds. Be sure to keep the laser away from your eyes.

Once the connection between the printer and the barcode checker is complete, the barcode checker icon appears on the status bar of the display.



Do a test read with the barcode checker to confirm that it functions correctly.

Note

If the printer cannot detect the barcode checker, check if the operational settings of the barcode check are appropriate.

7.6.4 Doing a Test Read with the Barcode Checker



Prepare a label on which the barcode data you use is printed by this printer. After performing operational settings of the barcode checker and then connecting it to the printer, perform a test read from the printer's **Settings** menu to confirm that the barcode checker functions correctly.

- 1 After connecting the barcode checker, press the  power button on the operator panel until the LED lights up in blue to power on the printer.

CAUTION

When the barcode checker is powered on, it emits a laser light for a few seconds. Be sure to keep the laser away from your eyes.

Once the connection between the printer and the barcode checker is complete, the barcode checker icon appears on the status bar of the display.

- 2 When the printer is in online mode, press the  button on the operator panel to change to offline mode.
- 3 Press the  button to show the **Settings** menu.

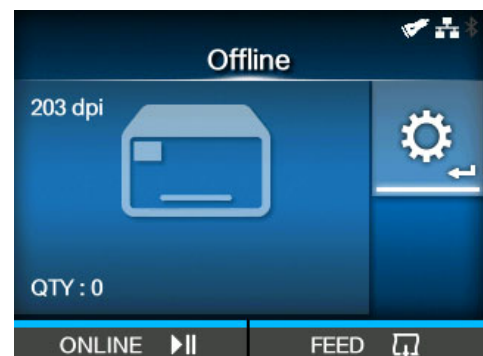

- 4 Press the ◀/▶ buttons to select **Tools**, and then press the ↵ button.

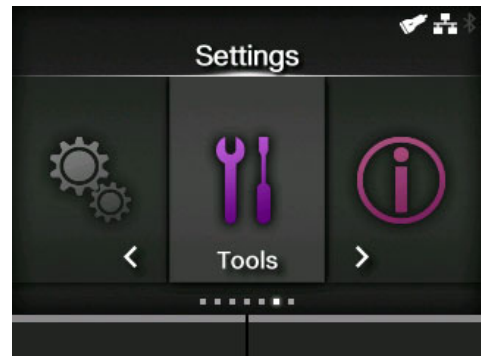

- 5 Press the ▲/▼ buttons to select **Barcode Checker > Test**, and then press the ↵ button.

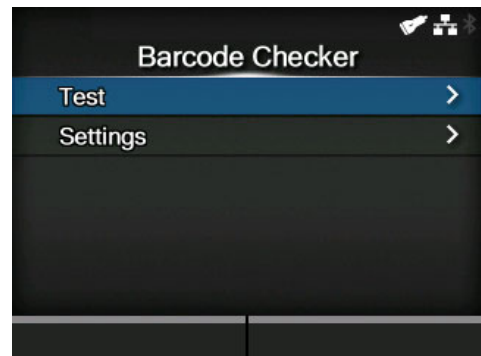

- 6 Confirm that the type of connected barcode checker is displayed on the right side of **Reader Name**.

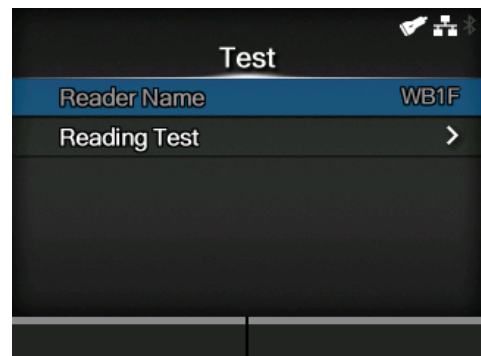

- 7 Press the ▲/▼ buttons to select **Reading Test**, and then press the ↵ button.
- 8 Set a label with barcodes within the scanning range of the barcode checker.

9 Press the right soft button to start reading the barcodes.

If reading is successful, the barcode type and data read are displayed on the screen. Only the first 23 bytes of data are displayed.

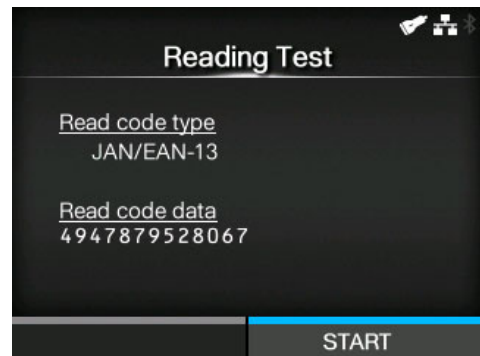
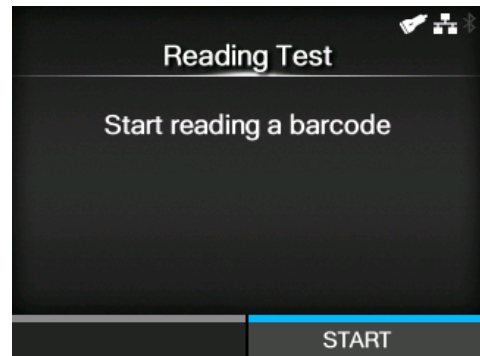

If reading is unsuccessful, or the displayed results of the read are not correct, adjust the position of the barcode checker by using the barcode checker stand. For details on how to use the barcode checker stand, refer to the Barcode Checker Stand Kit Installation Manual that came with the barcode checker stand kit.

Note

If the printer cannot detect the barcode checker, check if the operational settings for the barcode checker are appropriate.

7.6.5 Enabling the Barcode Check

The barcode check function has a readable mode and a comparison mode. You can switch the mode or disable the function from the printer's **Settings** menu.

- 1 When the printer is in online mode, press the **▶||** button on the operator panel to change to offline mode.
- 2 Press the **←** button to show the **Settings** menu.
- 3 Press the **◀/▶** buttons to select **Tools**, and then press the **←** button.
- 4 Press the **▲/▼** buttons to select **Barcode Checker > Settings > Mode**, and then press the **←** button.

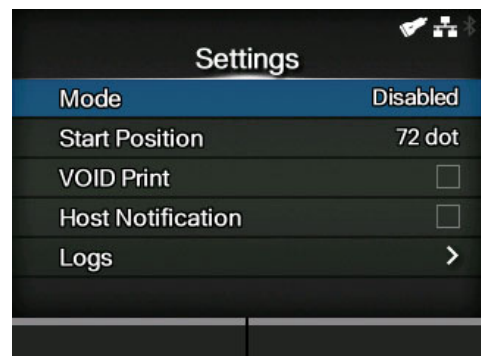
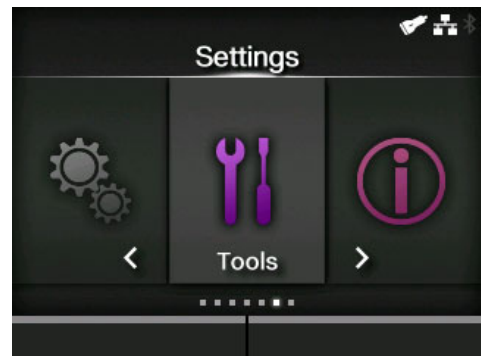

5 Press the ▲/▼ buttons to select the mode for the barcode check function.

The options are as follows:.

- **Disabled:** Disable the barcode check function.
- **Readable:** Enable readable mode.
- **Comparison:** Enable comparison mode.

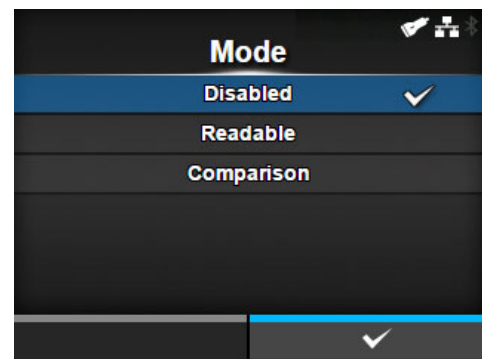

6 Press the right soft button to save the setting value.

Note

- When the readable mode or comparison mode is set, a barcode reader connection error occurs if the barcode checker is not connected at printer startup or at the start of printing.
 - Even if the readable mode or comparison mode is set, the barcode check is not done for print data that does not include any barcode data. Normal printing is done for that data.
 - When **Void Print** is enabled, you can identify a defective label by printing error marks on it.
 - The log data of barcode check results is saved on the printer and can be copied to the USB memory from the **Logs** menu. By enabling **Host Notification**, you can also return check results to the host from which the print data is sent.
-

Contents of the Check for Readable Mode and Comparison Mode

The barcode check function has readable mode and comparison mode. The contents of the check for each mode are as follows.

Note

- You can check multiple barcodes on one label. Though the number of barcodes on one label is not limited, a reading error occurs when the total size of the barcode data exceeds 200 Kb.
- Reading of barcodes starts after the label length specified in **Start Position** passes. In modes where the printer backfeeds before printing, the printer backfeeds first, and then feeds the length specified in **Start Position**.

Readable mode

This mode checks if the printed barcodes are readable. The readability is determined by whether the number of barcodes the barcode checker reads matches the number of barcodes in the print data.

- The reading is considered to be successful if the number of barcodes the barcode checker reads reaches the number of barcodes in the print data. The printer prints the next label.

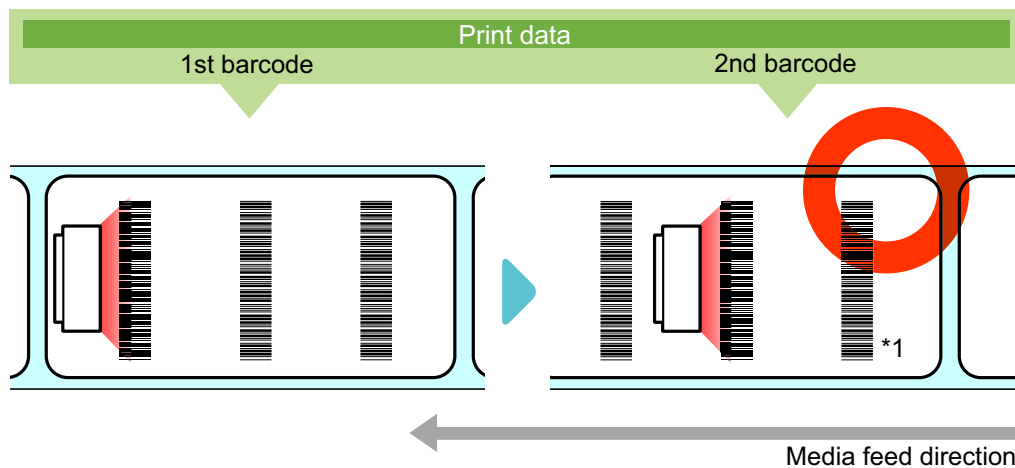

*1 Even if the number of barcodes the barcode checker reads exceeds the number of barcodes in the print data, it is considered to be successful.

- A reading error occurs if the number of barcodes in the print data is not read within the printing period from start to finish and the timeout period (up to 2 seconds).

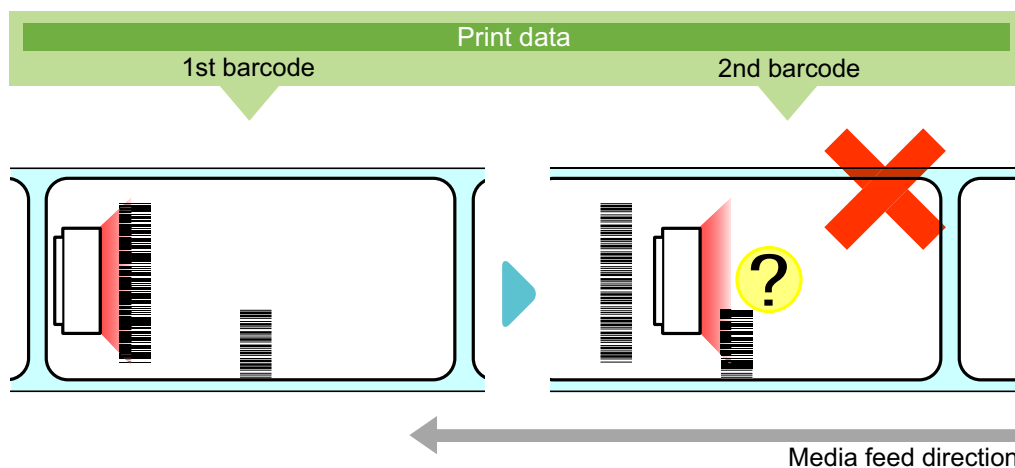

Comparison mode

This mode checks if the read results of the printed barcodes match the barcode data in the print data.

- The reading is considered to be successful if the read results of the printed barcodes match the barcode data in the print data. The printer prints the next label.

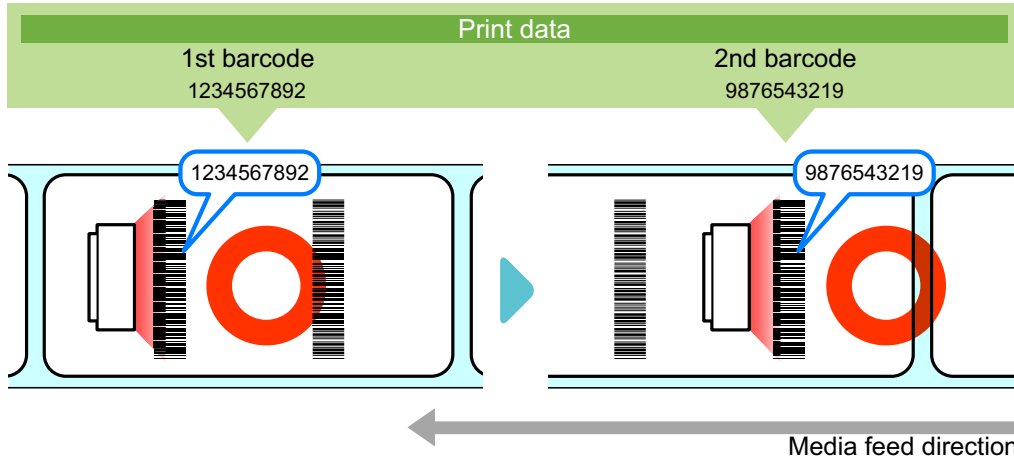

- A comparison error occurs if the read results of the printed barcodes do not match the barcode data in the print data.

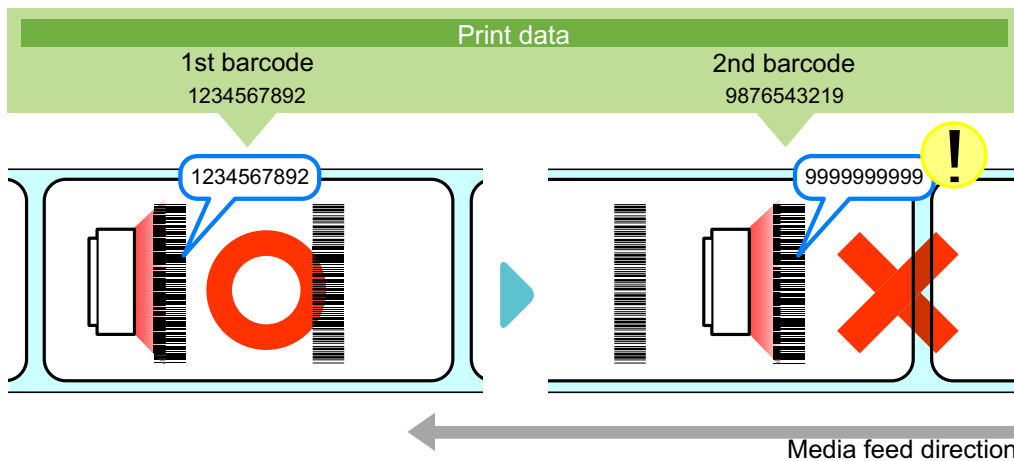

- A reading error occurs if the number of barcodes in the print data is not read within the printing period from start to finish and the timeout period (up to 2 seconds), even if the read results of the printed barcodes do not match the barcode data in the print data.

7.6.6 Restrictions for the Barcode Check Function

Common Restrictions for the Barcode Check Function

CAUTION

When the printer is powered on while the barcode checker is connected, the barcode checker is also powered on and emits a laser light for a few seconds. Be sure to keep the laser away from your eyes.

- The reading accuracy of barcodes or 2D codes is affected by label conditions (label curl, print quality, etc.) and the usage environment (ambient light, temperature, humidity, etc.), and readability is not guaranteed. Be sure to do a test read with the barcode checker you will use in advance.
- The types of paper that can be used are the same as the printer specifications. If the label color is silver or laminated, however, it makes it difficult for the barcode checker to read the barcode, as the light of the barcode checker may cause a reflection on the label surface. Be sure to do a test read carefully in advance.
- Design the label layout so that barcodes or 2D codes do not remain within the scanning range of the barcode checker at the completion of printing. If the barcode of the previous label remains in the scanning range at the start of the next printing, the barcode checker may read the same barcode twice. The image below is when in continuous mode. As the stop position differs depending on the printer's print mode and commands, be sure to check your label layout carefully in advance.

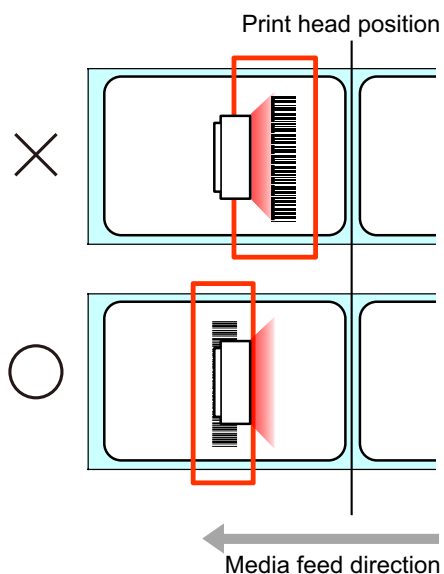

- Barcodes printed within the following range from the print end position cannot be read and a reading error inevitably occurs. As the following table is only for a reference, be sure to do a test read carefully in advance.

Print modes	Ranges to be avoided
Continuous	Approximately 11 mm (0.43") from the print end position
Cutter	<ul style="list-style-type: none"> • Cutting every label Approximately 25 mm (0.98") from the print end position • Cutting according to the specified number of labels Approximately 44 mm (1.73") from the print end position
Cut & Print	Approximately 44 mm (1.73") from the print end position
Dispenser	No restriction
Linerless (CL4NX only)	Approximately 25 mm (0.98") from the print end position

- The barcode check is not performed if the position at which the check starts is detected after the label feeding begins to stop. Define the label layout and position at which the check starts by keeping in mind that the distance required for stopping is proportional to the print speed.
- Printed barcodes or 2D codes can be read only with a size at which their entire pattern is within the scanning range of the barcode checker. A reading error may occur depending on the print position.
- This function cannot be controlled through the use of external signals (EXT).

Restrictions When Using GFS4470

- By the double-reading prevention function, the barcode checker may not read barcodes that are printed successively if they are within the readable area. Adjust the print position so that same barcodes are not within the readable area.
- When printing composite symbols that use GS1 DataBar, the read data and print data never match if the barcode data is 16 digits or less. A comparison error occurs in comparison mode.
- Though "\ (0x5C) specified in MAXI code, print data should be read as "\" in the specifications. However, it may not be read as such, depending on the following data. For example, "\A" specified in print data should be read as "\\A" in the specifications, but it is actually read as only "A".

Restrictions When Using WB1F-100S1S

- Multiple barcodes cannot be read at the same time.
- When NUL (0x00) is included in CODE128 print data, only the data before NUL is recognized as reading data, and NUL and the data after NUL are ignored. A comparison error occurs in comparison mode. In readable mode, a reading error occurs only if NUL is specified at the beginning of the print data.

7.7 Printer Specifications

Specifications are subject to change without notice.

7.7.1 Hardware

Model	CL4NX	CL6NX
Dimensions and Weight		
Width	271 mm (10.67")	338 mm (13.31")
Height	321 mm (12.64")	321 mm (12.64")
Depth	457 mm (18.00")	457 mm (18.00")
Weight	Approximately 15.1 kg (33.28 lbs.)	Approximately 20.3 kg (44.75 lbs.)
Power Supply		
Input Voltage	AC 100 V - 240 V \pm 10%	
Frequency	50 - 60 Hz	
Power Consumption	At peak: 180 W / 190 VA (Print ratio 30%) Standby: 20 W / 40 VA	At peak: 240 W / 308 VA (Print ratio 30%) Standby: 23 W / 63 VA
Processing		
Flash ROM	CPU1: 2 GB, CPU2: 4 MB	
SDRAM	CPU1: 256 MB, CPU2: 64 MB	
User Registration Area	Maximum 679 MB	
Receive Buffer	Maximum: 2.95 MB Near full: 2 MB	
Operation		
LCD	TFT color 3.5 inch (88.9 mm)	
LED	STATUS: Blue/Red	
Display Language	English / German / French / Spanish / Italian / Portuguese / Brazilian Portuguese / Czech / Danish / Dutch / Finnish / Greek / Hungarian / Norwegian / Polish / Romanian / Russian / Slovak / Swedish / Turkish / Chinese (Simplified) / Chinese (Traditional) / Korean / Japanese / Arabic / Thai / Vietnamese / Persian / Indonesian / Hindi / Bulgarian	

Model	CL4NX	CL6NX
Environmental Conditions (Without Media and Ribbon)		
Operating Temperature	Continuous/Cutter/Tear-off mode: 0 to 40 °C (32 to 104 °F) Dispenser/Linerless mode: 5 to 35 °C (41 to 95 °F)	Continuous/Cutter/Tear-off mode: 0 to 40 °C (32 to 104 °F) Dispenser mode: 5 to 35 °C (41 to 95 °F)
Storage Temperature	-20 to 60 °C (-4 to 140 °F)	
Operating Humidity	Continuous/Dispenser/Cutter/ Tear-off mode: 30 to 80% RH (Non-condensing) Linerless mode: 30 to 75% RH (Non-condensing)	30 to 80% RH (Non-condensing)
Storage Humidity	30 to 90% RH (Non-condensing)	
Print		
Print Method	Direct thermal and thermal transfer	
Print Speed	203 dpi: 2 to 10 inches/sec (50.8 to 254 mm/sec) 305 dpi: 2 to 8 inches/sec (50.8 to 203.2 mm/sec) 609 dpi: 2 to 6 inches/sec (50.8 to 152 mm/sec) Linerless mode: 2 to 6 inches/sec (50.8 to 152 mm/sec)	203 dpi: 2 to 10 inches/sec (50.8 to 254 mm/sec) 305 dpi: 2 to 8 inches/sec (50.8 to 203.2 mm/sec)
Resolution	203 dpi (8 dots/mm) 305 dpi (12 dots/mm) 609 dpi (24 dots/mm)	203 dpi (8 dots/mm) 305 dpi (12 dots/mm)
Non-printable Area	Pitch direction (Excludes liner) Top: 1.5 mm (0.06"), Bottom: 1.5 mm (0.06") Width direction (Excludes liner) Left: 1.5 mm (0.06"), Right: 1.5 mm (0.06")	
Printable Area	203 dpi: Length 2500 mm (98.42") x Width 104 mm (4.09") 305 dpi: Length 1500 mm (59.05") x Width 104 mm (4.09") 609 dpi: Length 400 mm (15.75") x Width 104 mm (4.09")	203 dpi: Length 2500 mm (98.42") x Width 152 mm (5.98") 305 dpi: Length 1500 mm (59.05") x Width 165.3 mm (6.50") * When Head Base Position is set to Left-justify: maximum print width 167.5 mm (6.59").
Print End Position	203 dpi: 1 to 20000 dots 305 dpi: 1 to 18000 dots 609 dpi: 1 to 9600 dots	203 dpi: 1 to 20000 dots 305 dpi: 1 to 18000 dots
Print Darkness	Darkness level: 1 to 10 Darkness range: A	

Model	CL4NX	CL6NX
Sensors		
I-mark (Reflective Type)	Position and sensitivity: Adjustable	
Gap (Transmissive Type)	Position and sensitivity: Adjustable	
Head Open	Fixed	
Paper End Sensor	Detect with I-mark sensor or Gap sensor	
Label Near End	Fixed * This feature is supported on printers from serial number 6B~ and above.	
Ribbon End/ Ribbon Near End	Fixed	
Dispenser	Fixed * If linerless cutter kit or dispenser unit is installed.	Fixed * If dispenser unit is installed.
Cutter	Fixed * If cutter unit or linerless cutter kit is installed.	Fixed * If cutter unit is installed.

7.7.2 Ribbon and Media

Model	CL4NX	CL6NX
Ribbon (Use genuine ribbon made by SATO.)		
Size	Length: maximum 600 m (1968.5 ft.) Width: 39.5 mm to 128 mm (1.55" to 5.04") *When the width is 39.5 mm (1.55"), the maximum length is 450 m (1476.4 ft.) * The maximum length varies depending on the ribbon type. * Use the ribbon that is wider than the media.	Length: maximum 600 m (1968.5 ft.) Width: 59 mm to 177 mm (2.32" to 6.98") * The maximum length varies depending on the ribbon type. * Use the ribbon that is wider than the media.
Wind Direction	Face-out/Face-in	
Winding Method	Coreless	
Media (Use genuine media made by SATO.)		
Type	Media roll (Face-in wound/face-out wound), Fan-fold media	
Size		
Continuous		
Pitch	203 dpi: 6 to 2497 mm (0.24" to 98.30") 305 dpi: 6 to 1497 mm (0.24" to 58.94") 609 dpi: 6 to 397 mm (0.24" to 15.63")	203 dpi: 16 to 2497 mm (0.63" to 98.30") 305 dpi: 16 to 1497 mm (0.63" to 58.94")
(With Liner)	203 dpi: 9 to 2500 mm (0.35" to 98.42") 305 dpi: 9 to 1500 mm (0.35" to 59.05") 609 dpi: 9 to 400 mm (0.35" to 15.75")	203 dpi: 19 to 2500 mm (0.75" to 98.42") 305 dpi: 19 to 1500 mm (0.75" to 59.05")
Width (With Liner)	22 to 128 mm (0.87" to 5.04") 25 to 131 mm (0.98" to 5.16")	47 to 177 mm (1.85" to 6.96") 50 to 180 mm (1.97" to 7.01")
Tear-off/Cutter		
Pitch	203 dpi: 17 to 2497 mm (0.67" to 98.30") 305 dpi: 17 to 1497 mm (0.67" to 58.94") 609 dpi: 17 to 397 mm (0.67" to 15.63")	203 dpi: 17 to 2497 mm (0.67" to 98.30") 305 dpi: 17 to 1497 mm (0.67" to 58.94")
(With Liner)	203 dpi: 20 to 2500 mm (0.79" to 98.42") 305 dpi: 20 to 1500 mm (0.79" to 59.05") 609 dpi: 20 to 400 mm (0.79" to 15.75") * When Print Mode is set to Cut & Print, the minimum pitch for each print speed is the following value: 2 ips: 40 mm (1.57"), 3 ips: 58 mm (2.28"), 4 ips: 75 mm (2.95"), 5 ips: 93 mm (3.66"), 6 ips: 110 mm (4.33"), 7 ips: 125 mm (4.92"), 8 ips: 140 mm (5.51"), 9 ips: 156 mm (6.14"), 10 ips: 171 mm (6.73")	203 dpi: 20 to 2500 mm (0.79" to 98.42") 305 dpi: 20 to 1500 mm (0.79" to 59.05") * When Print Mode is set to Cut & Print, the minimum pitch for each print speed is the following value: 2 ips: 40 mm (1.57"), 3 ips: 58 mm (2.28"), 4 ips: 75 mm (2.95"), 5 ips: 93 mm (3.66"), 6 ips: 110 mm (4.33"), 7 ips: 125 mm (4.92"), 8 ips: 140 mm (5.51"), 9 ips: 156 mm (6.14"), 10 ips: 171 mm (6.73")
Width (With Liner)	22 to 128 mm (0.87" to 5.04") 25 to 131 mm (0.98" to 5.16")	47 to 177 mm (1.85" to 6.96") 50 to 180 mm (1.97" to 7.01")

* Above pitch and width are valid for die-cut labels. For media without liner like tags, refer to the value 'with liner'.

Model	CL4NX	CL6NX
Media (Use genuine media made by SATO.)		
Size		
Dispenser		
Pitch (With Liner)	27 to 397 mm (1.06" to 15.63") 30 to 400 mm (1.18" to 15.75")	
Width (With Liner)	22 to 128 mm (0.87" to 5.04") 25 to 131 mm (0.98" to 5.16")	47 to 177 mm (1.85" to 6.97") 50 to 180 mm (1.97" to 7.01")
Diameter of Liner Winding	Maximum 120 mm (4.72")	
Linerless		
Pitch	30 to 120 mm (1.18" to 4.72")	—
Width	60 to 118 mm (2.36" to 4.65")	—
Roll Diameter (Media Roll)	Maximum 220 mm (8.66") When using a dispenser with liner rewinder: maximum 220 mm (8.66")	
Core Diameter (Media Roll)	76 mm, 101 mm (3", 4") When using a dispenser with liner rewinder: 76 mm (3") * Recommend to use 4" core for thick paper (more than 150 µm), non-adhesive media and RFID tags (CL4NX only)/labels.	
Height (Fan-fold Media)	Maximum 200 mm (7.87") * When the printer and media are configured to the same height.	
Thickness	0.06 to 0.268 mm (0.0024" to 0.011")	

* Above pitch and width are valid for die-cut labels. For media without liner like tags, refer to the value 'with liner'.

Note

The usable media sizes, the print speed and print quality vary depending on the media specification, media and ribbon combination, printer settings and printing environment. It is recommended to perform a test print with the media and ribbon to be used in advance.

7.7.3 Interface

Model		CL4NX	CL6NX
Interface			
Standard		USB Interface (Type B) LAN Interface Bluetooth Interface NFC Interface *This feature is supported on printers from serial number 6B~ and above. USB Interface (Type A) x 2 RS-232C Interface IEEE1284 Interface External Signal Interface (EXT)	
Option Board		Wireless LAN Interface	
RFID	UHF (920 MHz)	ISO/IEC 18000-6 Type C Gen2	—
	HF (13.56 MHz)	ISO/IEC 15693 (ICODE SLI/SLIX/ SLIX-S, Tag-it HF-I, my-d) ISO/IEC 14443 Type A (NTAG203, NTAG210, NTAG213/215/216, MIFARE UltraLight, MIFARE UltraLight C, my-d move NFC) ISO/IEC 18092 (FeliCa Lite-S)	—

7.7.4 Built-in Functions

Model	CL4NX	CL6NX
Functions		
Built-in Functions	Status return Graphic Sequential number Form overlay Character modification Black/white inversion Ruled line Dump list Format registration Outline font Outline modification Zero slash switching Guidance Video	
Self-diagnosis Functions	Broken head element check Head open detection Paper end detection Label near-end detection *This feature is supported on printers from serial number 6B~ and above. Ribbon end detection Ribbon near-end detection Test print Cutter open check (If cutter unit is installed) Label detection at dispensing (If dispenser unit is installed)	
Adjustment Functions	Print Darkness Print Position Media Stop Position Buzzer LCD Brightness	

7.7.5 Printer Languages

Model	CL4NX	CL6NX
Printer Languages		
	SBPL (Includes XML support) SZPL SDPL SIPL STCL SEPL AEP	

7.7.6 Fonts/Symbols/Barcodes

Model	CL4NX	CL6NX
Fonts		
Bitmap Fonts		
U	9 dots H x 5 dots W	
S	15 dots H x 8 dots W	
M	20 dots H x 13 dots W	
WB	30 dots H x 18 dots W	
WL	52 dots H x 28 dots W	
XU	9 dots H x 5 dots W	
XS	17 dots H x 17 dots W	
XM	24 dots H x 24 dots W	
XB	48 dots H x 48 dots W	
XL	48 dots H x 48 dots W	
X20	9 dots H x 5 dots W	
X21	17 dots H x 17 dots W	
X22	24 dots H x 24 dots W	
X23	48 dots H x 48 dots W	
X24	48 dots H x 48 dots W	
OCR-A	203 dpi: 22 dots H x 15 dots W 305 dpi: 33 dots H x 22 dots W 609 dpi: 66 dots H x 44 dots W	203 dpi: 22 dots H x 15 dots W 305 dpi: 33 dots H x 22 dots W
OCR-B	203 dpi: 24 dots H x 20 dots W 305 dpi: 36 dots H x 30 dots W 609 dpi: 72 dots H x 60 dots W	203 dpi: 24 dots H x 20 dots W 305 dpi: 36 dots H x 30 dots W
JIS208 Kanji Fonts (Mincho/Gothic)	16 dots H x 16 dots W 24 dots H x 24 dots W 22 dots H x 22 dots W 32 dots H x 32 dots W 40 dots H x 40 dots W	
JIS0213 Kanji Fonts (Gothic)	16 dots H x 16 dots W 24 dots H x 24 dots W 22 dots H x 22 dots W 32 dots H x 32 dots W 40 dots H x 40 dots W	
Compatible Kanji Fonts (Mincho)	16 dots H x 16 dots W 24 dots H x 24 dots W	
Simplified Chinese Characters	16 dots H x 16 dots W 24 dots H x 24 dots W	

Model	CL4NX	CL6NX
Fonts		
Bitmap Fonts		
Traditional Chinese Characters	24 dots H x 24 dots W	
Korean Fonts	16 dots H x 16 dots W 24 dots H x 24 dots W	
Scalable Fonts		
Rasterized Font	SATO CG Sleek SATO CG Stream SATO 0 SATO Alpha Bold Condensed SATO Beta Bold Italic SATO Folio Bold SATO Futura Medium Condensed SATO Gamma SATO OCR-A SATO OCR-B SATO Sans SATO Serif SATO Vica SATO Hebe Sans SATO Hebe Sans Arabic SATO Hebe Sans Thai SATO Hebe Sans Hebrew SATO Hebe Sans Hindi SATO Gothic Traditional Chinese SATO Gothic Japanese SATO Gothic Simplified Chinese SATO Gothic Korean SATO Silver Serif SATO Mincho Traditional Chinese SATO Mincho Japanese SATO Mincho Simplified Chinese SATO Mincho Korean SATO Roman Arabic SATO Symbol Set SATO WingBats	
Outline Fonts	Helvetica Outline Font	
	JIS208 Kanji Outline Fonts	

Model	CL4NX	CL6NX
Barcodes		
1D Barcodes	UPC-A/UPC-E JAN/EAN-13/8 CODE39, CODE93, CODE128 GS1-128(UCC/EAN128) CODABAR(NW-7) ITF Industrial 2 of 5 Matrix 2 of 5 MSI Customer Barcode POSTNET UPC add-on code USPS BOOKLAND GS1 DataBar Omnidirectional GS1 DataBar Truncated GS1 DataBar Stacked GS1 DataBar Stacked Omnidirectional GS1 DataBar Limited GS1 DataBar Expanded GS1 DataBar Expanded Stacked	
2D Codes	QR Code Micro QR Code PDF417 Micro PDF Maxi Code GS1 Data Matrix Data Matrix (ECC200) Aztec Code	
Composite Symbols	EAN-13 Composite (CC-A/CC-B) EAN-8 Composite (CC-A/CC-B) UPC-A Composite (CC-A/CC-B) UPC-E Composite (CC-A/CC-B) GS1 DataBar Composite (CC-A/CC-B) GS1 DataBar Truncated Composite (CC-A/CC-B) GS1 DataBar Stacked Composite (CC-A/CC-B) GS1 DataBar Expanded Stacked Composite (CC-A/CC-B) GS1 DataBar Expanded Composite (CC-A/CC-B) GS1 DataBar Stacked Omnidirectional Composite (CC-A/CC-B) GS1 DataBar Limited Composite (CC-A/CC-B) GS1-128 Composite (CC-A/CC-B/CC-C)	

7.7.7 Options

Model	CL4NX	CL6NX
Options		
	1) Cutter unit 2) Linerless cutter kit 3) Dispenser unit (with internal liner rewriter) 4) Simple dispenser kit 5) Internal liner rewriter kit 6) RTC (Calendar) kit 7) UHF RFID kit 8) HF RFID kit 9) Wireless LAN interface kit 10) External rewriter (RWG500) 11) Barcode checker stand kit 12) External cover kit	1) Cutter unit 2) Dispenser unit (with internal liner rewriter) 3) Simple dispenser kit 4) Internal liner rewriter kit 5) RTC (Calendar) kit 6) Wireless LAN interface kit 7) External rewriter (RWG500) 8) Barcode checker stand kit 9) External cover kit

7.7.8 Accessories

Model	CL4NX	CL6NX
Accessories		
	1) Power cord 2) Documentations (Quick Guide, Global Warranty Program leaflet, etc.)	

7.7.9 Standards

Model	CL4NX	CL6NX
Standards		
Safety Standards	UL 60950-1 CSA C22.2 No.60950-1 EN60950-1 CCC KC RCM IRAM BIS EAC	
EMC Standards	FCC-B, FCC-C ICES-003, IC EN55022 Class A, EN55024, R&TTE CCC, SRRC KC IDA SIRIM PTQC NTC DGPT RCM IRAM, CNC ANATEL WPC	
Environmental Standard RoHS	RoHS directive (six hazardous) restricts the use of six hazardous materials listed below. Hexavalent chromiumMax. 0.1% Lead and lead compoundsMax. 0.1% Mercury and mercury compoundsMax. 0.1% Cadmium and cadmium compoundsMax. 0.01% Polybrominated biphenyls (PBB)Max. 0.1% Polybrominated diphenyl ethers (PBDE)Max. 0.1%	
Compliance Status of REACH Regulation	(1) Status of registered chemical substances No chemical substances are intentionally emitted, nor are there any chemical substances that are registered with the European Chemicals Agency. (2) Information about the Substances of Very High Concern (SVHC) contained in the printer As of August 3, 2015, there has been no information communicated regarding SVHC that exceed 0.1% of the printer's weight. In the future, if SVHC that exceed 0.1% of the printer's weight are found, we will immediately communicate that information.	
Energy Saving	International ENERGY STAR® program	

7.8 Interface Specifications

For data communication with the host, this printer supports the following interfaces:
You can set the various interface settings of the printer through **Interface** in the **Settings** menu.

- USB (USB type B)
- LAN Ethernet
- Bluetooth
- NFC
 - *This feature is supported on printers from serial number 6B~ and above.
- RS-232C (DB 9 pins, female)
- IEEE1284 (Amphenol 36 pins)
- External signal (EXT) (Amphenol 14 pins)
- Wireless LAN

CAUTION

Do not connect or disconnect the interface cables (or use a switch box) with power supplied to either the printer or host. This may cause damage to the interface circuitry in the printer or host and is not covered by warranty.

Note

- Wireless LAN is an optional interface.
 - You cannot use the wireless LAN interface and LAN interface at a time.
 - The NFC interface supports the handover function that simplifies the Bluetooth/Wi-Fi connection setup with Android devices. For details, refer to [Section 2.4.3 NFC Interface Connection](#).
In addition, the NFC interface can be used for changing printer settings with an Android device while the printer is powered off and the power cord is not connected.
-

7.8.1 USB Interface

This interface complies with the USB2.0 standard.
Install the USB driver to the computer before use.

Basic Specifications	
Connector	USB Type B connector
Protocol	Status4, Status5
Power Supply	BUS Power through cable

Pin Assignments	
Pin No.	Description
1	VBus
2	-Data
3	+Data
4	GND

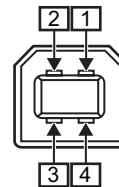

Cable Specifications	
Cable Connector	USB Type B connector
Cable Length	5 m (16.4 feet) or less

7.8.2 LAN Ethernet Interface

Basic Specifications	
Connector	RJ-45 Receptacle
Protocol	Status3 Status4 Status5
IP Address	IPv4 IPv6
Subnet Mask	IPv4 IPv6
Gateway Address	IPv4 IPv6

Cable Specifications	
Cable	10BASE-T/100BASE-TX Category 5
Cable Length	100 m (328 feet) or less

Software Specifications	
Supported Protocol	TCP/IP
Network Layer	IP, ICMP
Session Layer	TCP
Application Layer	LPD, FTP, DHCP, HTTPS, SNMP, NTP

7.8.3 Bluetooth Interface

This interface complies with the Bluetooth3.0+EDR standard.

Basic Specifications	
Signal Level	Class 2
Communication Distance	10 m (32.8 feet)
Profile	Serial Port Profile
Security Level	None, level 2, 2-1, 2-2, level 3, level 4
PIN Code	1 to 16 characters consisting of ASCII code (20H, 21H, 23H to 7EH)
Disconnect Timeout (LMP layer)	60 seconds

7.8.4 NFC Interface

This interface complies with the NFC Forum Type 2 Tag.

Note

This feature is supported on printers from serial number 6B~ and above.

7.8.5 RS-232C Interface

This interface complies with the RS-232C standard.

Basic Specifications	
Asynchronous ASCII	Half-duplex communication Bi-Directional Communication
Data Transmission Rate	2400, 4800, 9600, 19200, 38400, 57600, 115200 bps
Transmission Form	Start, b1, b2, b3, b4, b5, b6, b7, b8, Stop "b8" will be omitted if using 7 bit oriented.
Data Length	7 or 8 bit (selected)
Stop Bit	1 or 2 bit (selected)
Parity Bit	ODD, EVEN, NONE (selected)
Codes Used	ASCII Character Codes: 7 bits, Graphics: 8 bits
Control Codes	STX (02H), ETX (03H), ACK (06H), NAK (15H)
Connector	DB-9 Female or equivalent
Signal Levels	High = +5 to +12 V, Low = -5 to -12 V
Protocol	Ready/Busy, XON/XOFF, Status3, Status4, Status5

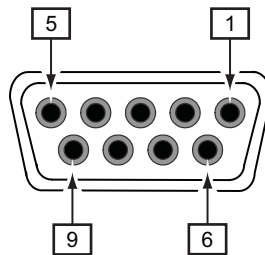

Connector Pin Specifications		
Pin No.	I/O	Description
1	-	Data Carrier Detect
2	Input	Receive Data
3	Output	Transmit Data
4	Output	Data Terminal Ready
5	Reference	Signal Ground
6	Input	Data Set Ready
7	Output	Request To Send
8	Input	Clear To Send
9	-	Not connected

Cable Specifications	
Cable Connector	DB-9 Male or equivalent
Cable Length	5 m (16.4 feet) or less

Note

- When using the READY/BUSY control, make sure that the printer is in power on mode before you send the data from the host.
 - With communication protocols such as XON/XOFF, STATUS3, STATUS4 or STATUS5, a receive buffer full error will occur when the received data is more than the receive buffer size (2.95 MB). Send data that is less than 2.95 MB while monitoring the status of the printer.
 - A parity error will be detected if this error occurs after the reception of ESC+A.
-

7.8.6 IEEE1284 Interface

This interface complies with the IEEE1284 standard.

Basic Specifications	
Connector	Amphenol 36 pins, female
Signal Levels	High-level: +2.4 to +5.0 V Low-level: +0.0 to +0.4 V
Receive Mode	Single-item buffer, Multi-item buffer

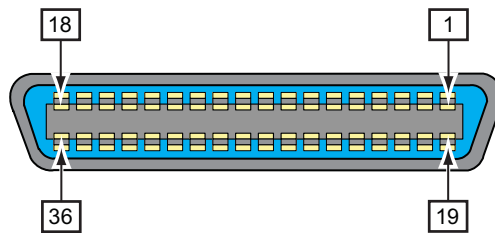

Connector Pin Specifications		
Pin No.	I/O	Description
1	Input	STROBE
2-9	Input	DATA 1 - DATA 8 DATA1: LSB DATA8: MSB
10	Output	ACK
11	Output	BUSY
12	Output	PAPER EMPTY/PAPER ERROR
13	Output	SELECT
14	Input	AUTO FEED
15	-	Not in use
16	-	LOGIC Ground
17	-	Frame Ground
18		+5 V
19	-	STROBE RETURN
20-27	-	DATA 1 - DATA 8 RETURN
28	-	ACK RETURN
29	-	BUSY RETURN
30	-	PAPER EMPTY RETURN
31	Input	INITIALIZE

Connector Pin Specifications		
32	Output	FAULT
33-35	-	Not in use
36	Input	SELECT INPUT

Cable Specifications	
Cable Connector	Amphenol 36 pins, male
Cable Length	1.5 m (5 feet) or less

7.8.7 External Signal Interface (EXT)

This interface is designed to connect the printer with other peripherals.

Basic Specifications	
Connector	Centronics IDC Type 14 pins (female)
Signal Levels	High-level: +4.2 to +5.0 V Low-level: +0.0 to +0.7 V

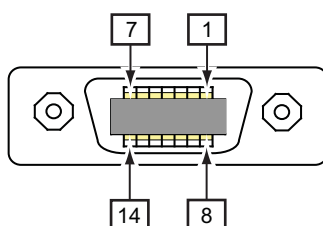

Connector Pin Specifications			
Pin No.	I/O	Description	Electric Conditions (Voltage, Current (Max))
1	Output	Paper End: Outputs a low signal when the paper end is detected.	Withstand voltage 50 V Sink current 50 mA
2	-	GND: Reference Signal Ground	-
3	Output	Ribbon End: Outputs a low signal when the ribbon end is detected.	Withstand voltage 50 V Sink current 50 mA
4	Output	Machine Error: Outputs a low signal when an error such as the head open error is detected.	Withstand voltage 50 V Sink current 50 mA
5	Input	Print start signal (PRIN): Prints one media when a low signal is detected.	High: high impedance Low: more than -15 mA, 0 V
6	Output	Print Done/Print end signal (PREND): Outputs a signal when the media print is completed.	Withstand voltage 50 V Sink current 50 mA
7	Input	Reprint signal (PRIN2): Prints the previously printed content again when a low signal is detected.	High: high impedance Low: more than -15 mA, 0 V
8	Input	External power supply	5 V
9	Output	<ul style="list-style-type: none"> MODE1: The output signal becomes "Active" when there is remaining print data without error in online mode. MODE2: The output signal becomes "Active" when the printer is Online. 	Withstand voltage 50 V Sink current 50 mA

Connector Pin Specifications			
10	Output	Ribbon Near End: Outputs a high signal when the ribbon near end is detected.	Withstand voltage 50 V Sink current 50 mA
11	-	-	-
12	-	+24 V \pm 10%	2 A
13	-	Vcc +5 V	500 mA
14	-	-	-
*	Output	Dispense completion waiting signal: Outputs a low signal when the dispense is completed. You can set the pin number for output through the Settings > Interface > External I/O > Signals > Outputs menu.	Withstand voltage 50 V Sink current 50 mA
*	Output	Label Near End signal: Outputs a high signal when the label near end is detected. You can set the pin number for output through the Settings > Interface > External I/O > Signals > Outputs menu. *This feature is supported on printers from serial number 6B~ and above.	Withstand voltage 50 V Sink current 50 mA

Note

- You can set the external signal (EXT) type (TYPE1 to TYPE4) for Print Done output signal of pin No. 6. Refer to the **EXT Mode** screen of the **Interface > External I/O > Signals** menu for details.
- You can set the pin number for input and output through the **Settings > Interface > External I/O > Signals > Inputs** and **Outputs** menu.
- The Print Done signal of pin No. 6 is not outputted when 0 is specified in the number of cuts in the command specifying the number of cuts during the cutter operation.

Timing Chart of the EXT Input Signal

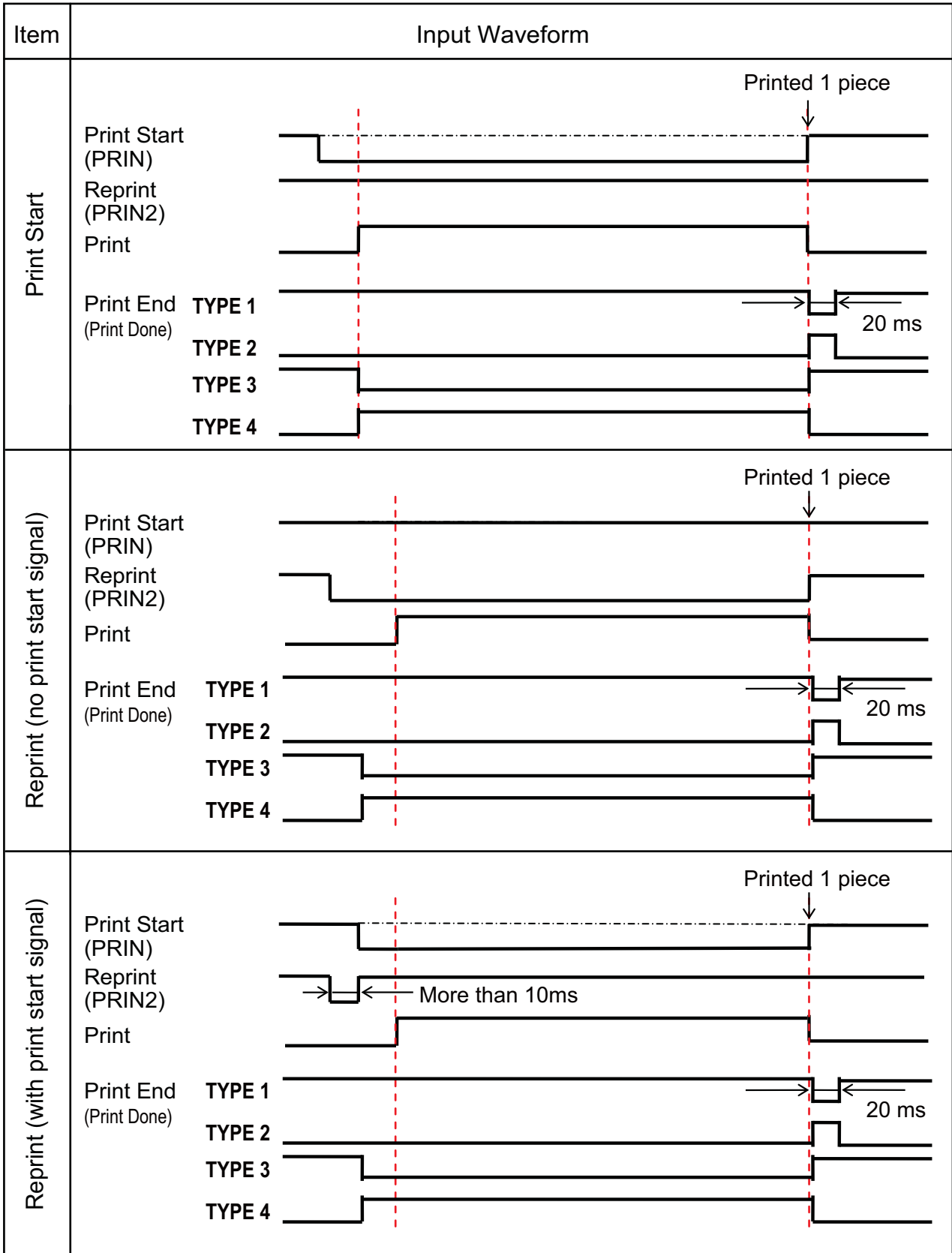

Supplementary explanation

- Keep the print start signal (PRIN) to “Low” until print end signal (Print done) is outputted. Refer to the below **Maintaining the Print Start Signal (PRIN)** timing chart.
- Keep the output reprint signal (PRIN2) for more than 10 ms. When signal is outputted for shorter than 10 ms, and reprint signal is not acknowledged, the printer does not perform reprinting.

Maintaining the Print Start Signal (PRIN)

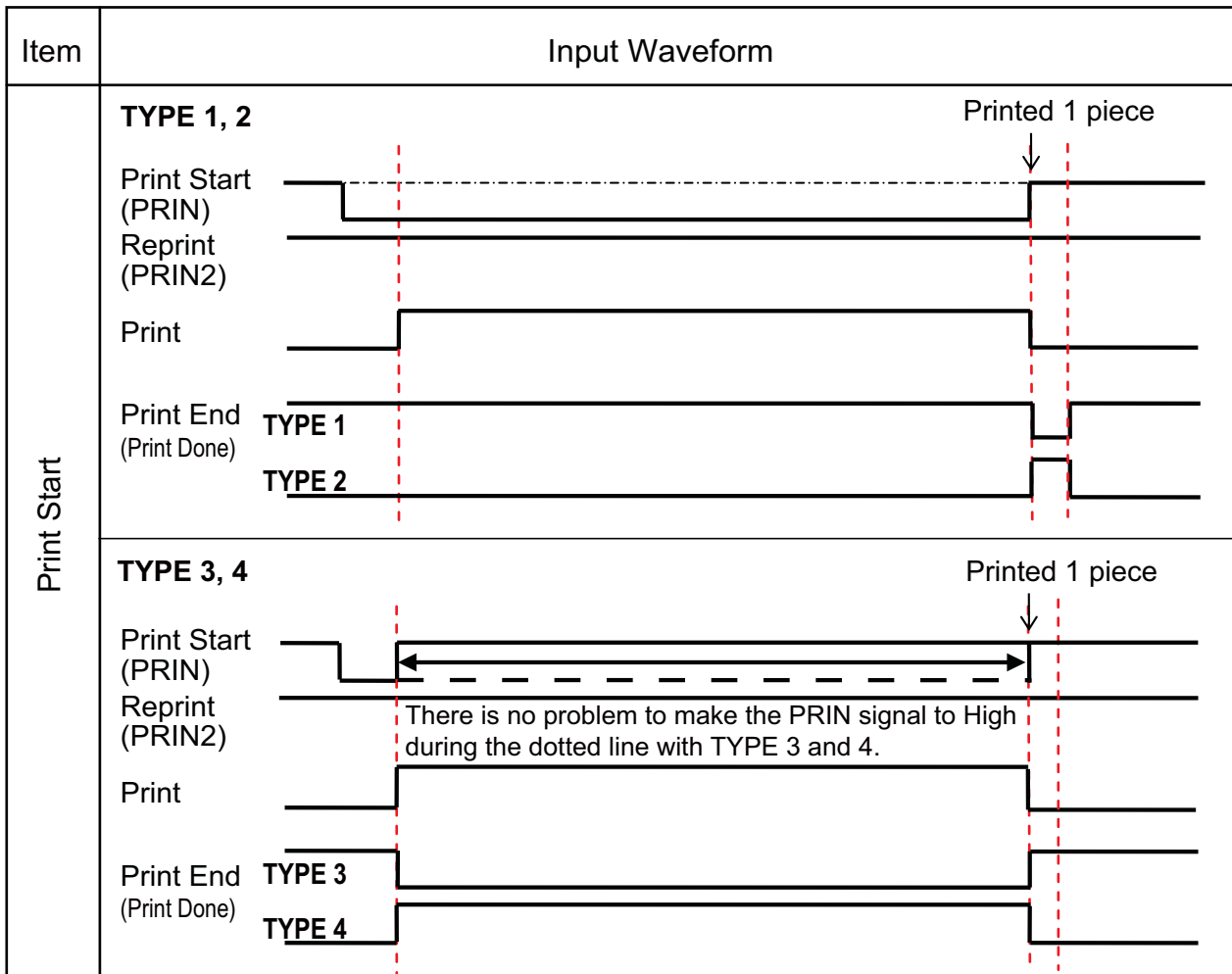

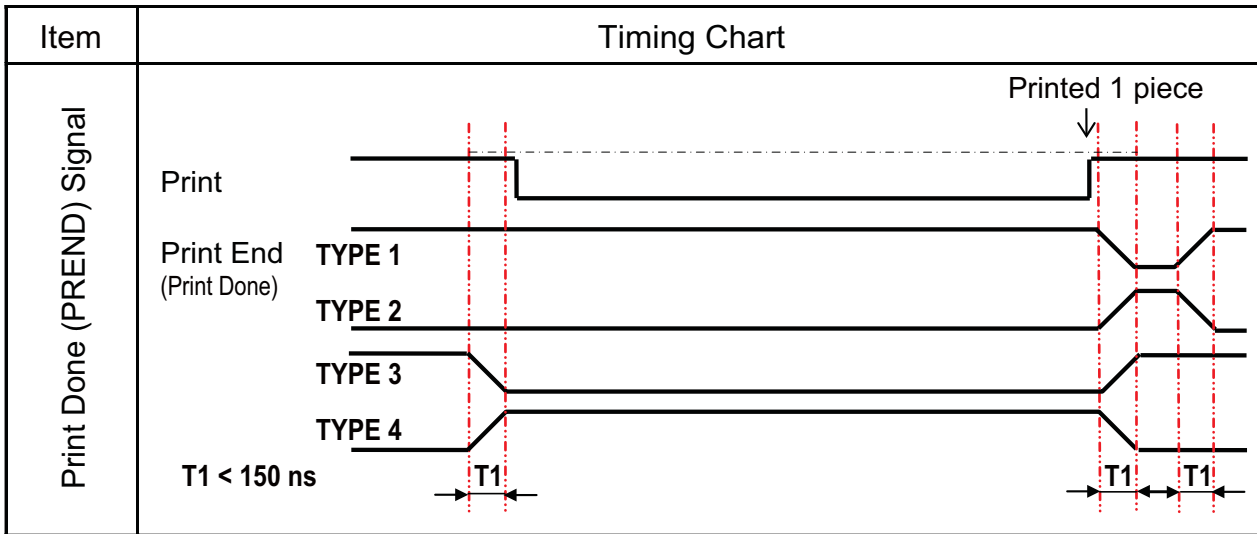

Rise or fall time ($T1$) of Print Done signal is less than 150 ns. You have to consider the time when outputting the signal from the connected devices.

- When the print start signal and reprint signal are outputted simultaneously, the print start signal is enabled and the printer does not perform reprinting.
- The reprint signal is valid only from the time of the print operation end ($QTY=0$) until the next print data reception. Other than that, the printer does not perform reprinting.

Timing Chart of the EXT Output Signal
 • Standard specification

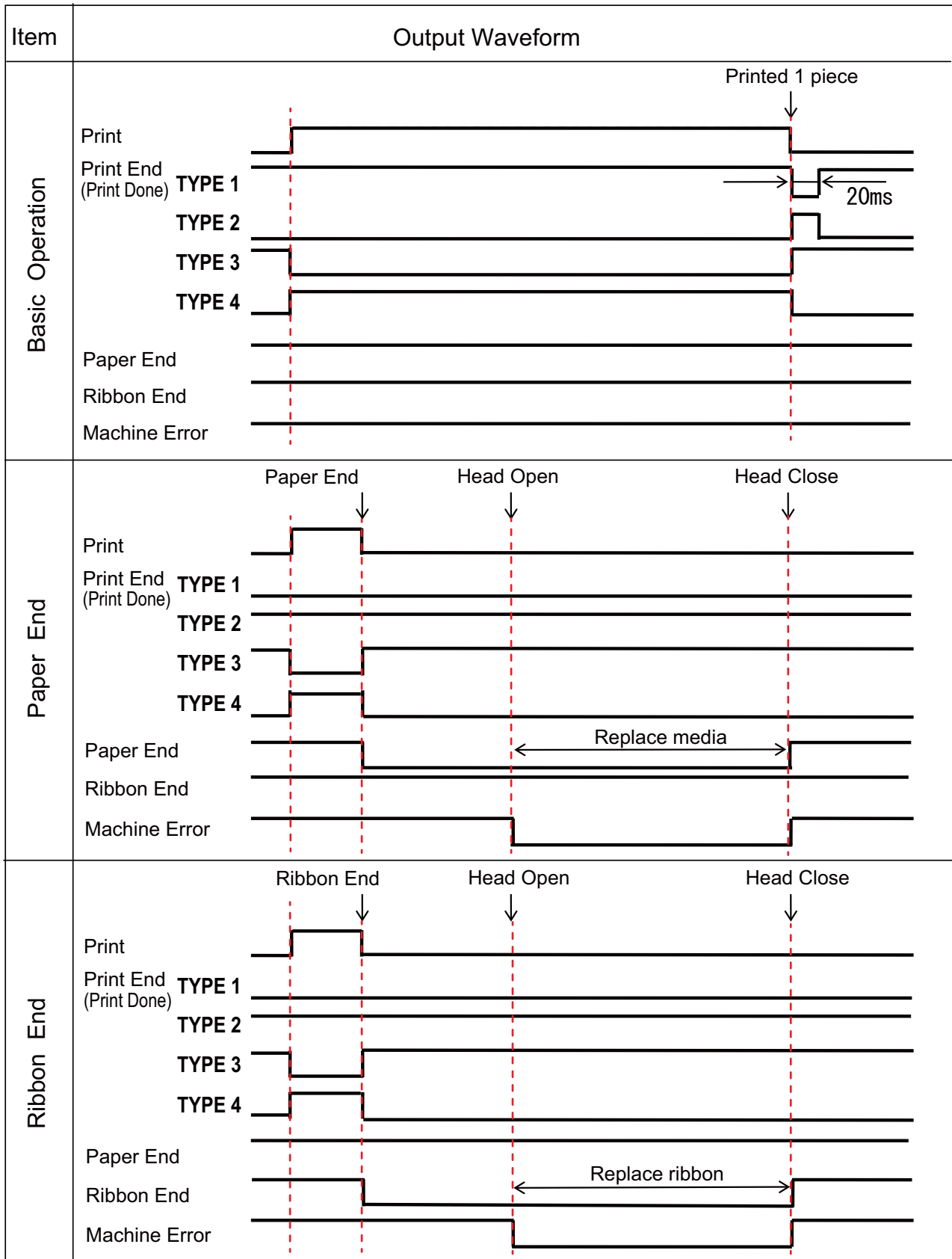

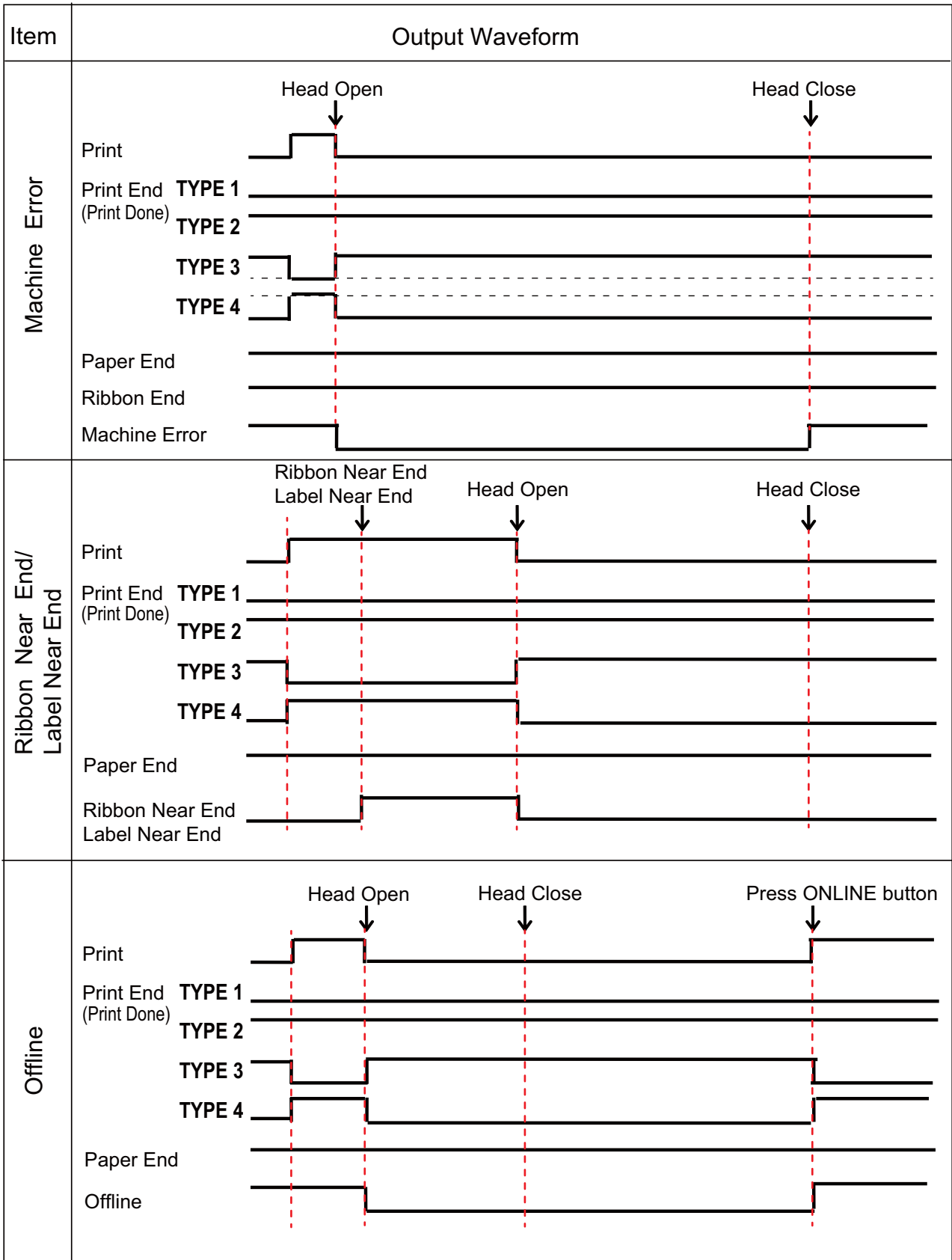

• When RFID Mode is enabled (CL4NX only)

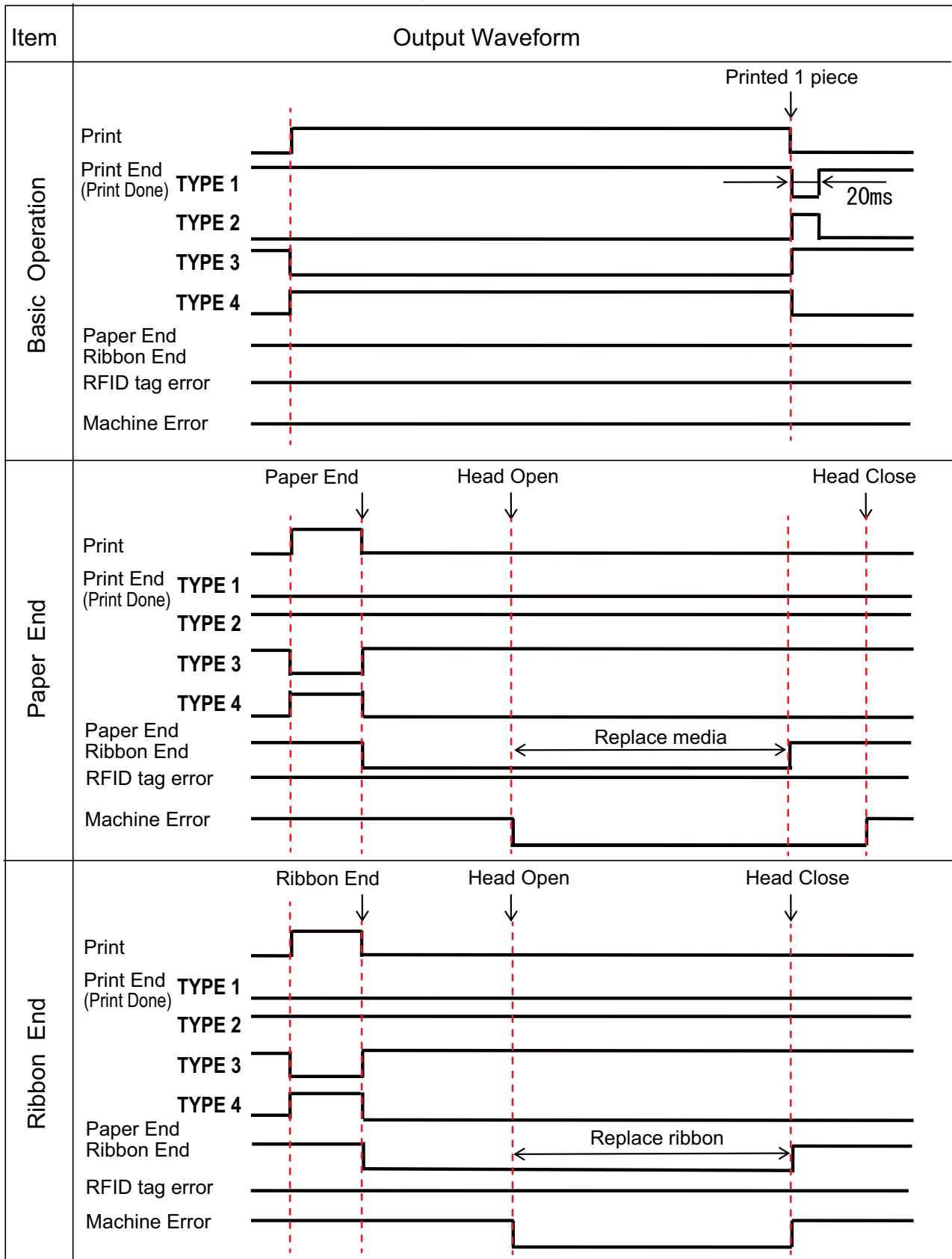

Timing Chart (Wait signal for dispense completion)

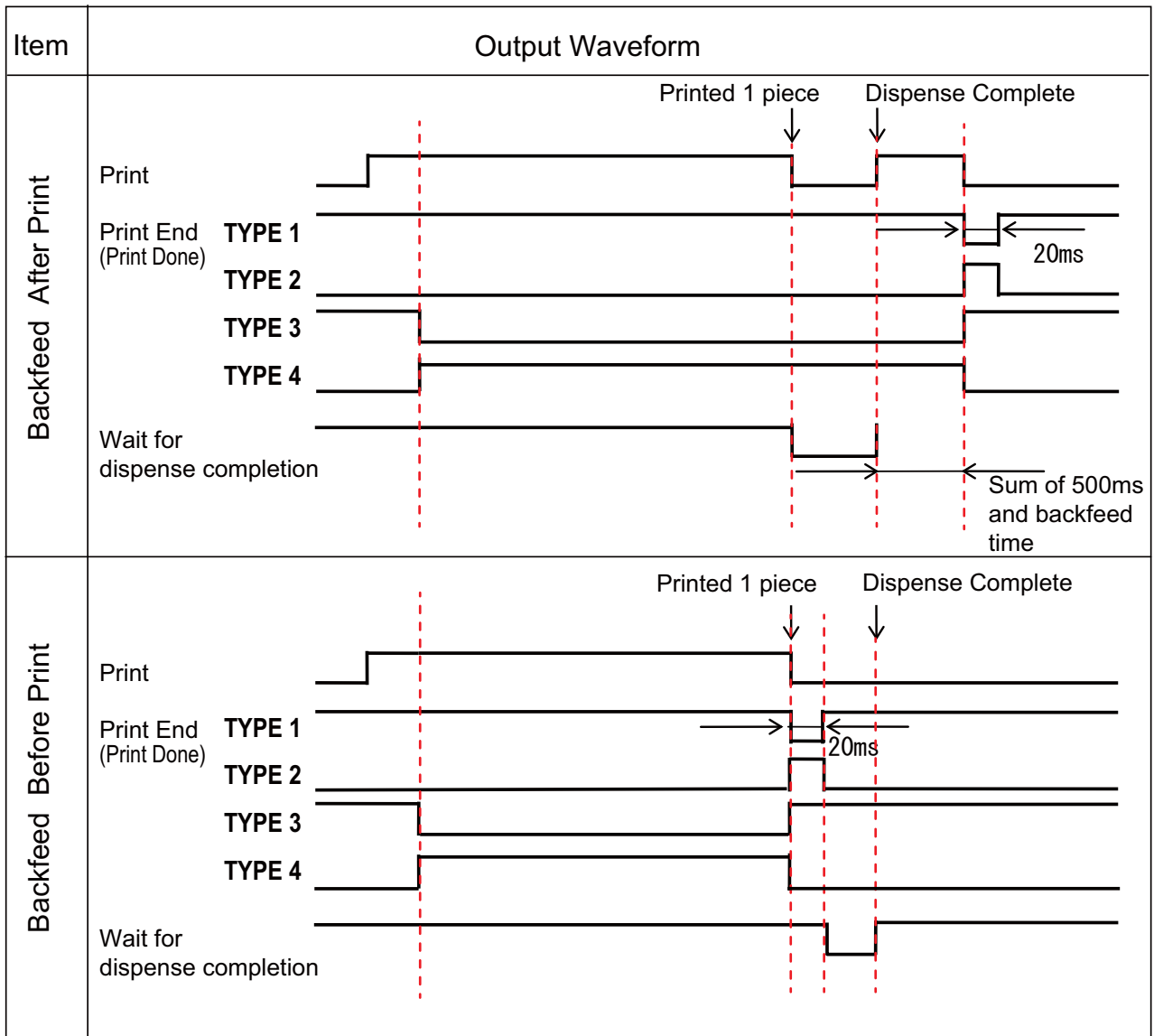

1. When the wait signal for dispense completion is enabled, note that the output timing of the print end signal (print done) differs between Backfeed After Print and Backfeed Before Print.
 - 1) In Backfeed After Print, the print end signal (print done) is output after the label waiting for dispense is removed and the printer backfeeds to the print start position.
 - 2) In Backfeed Before Print, the print end signal (print done) is output after the printer feeds the label to the dispense position.

2. "Printed 1 piece" includes the operation of the printer feeding the label to the dispense position after printing.

7.8.8 Wireless LAN Interface

This interface complies with the IEEE802.11a/b/g/n standard.

CAUTION

Before using wireless LAN near medical devices and facilities, consult your system administrator.

Basic Specifications	
Protocol	Status3, Status4, Status5
IP Address	IPv4 IPv6
Subnet Mask	IPv4 IPv6
Gateway Address	IPv4 IPv6
Data Transfer Method	802.11a: max 54 Mbps 802.11n: max 135 Mbps 802.11b: max 11 Mbps 802.11g: max 54 Mbps <hr/> Note These are the logical values based on the wireless LAN specifications and are not the actual data transfer speeds.
Frequency Band	2.4 GHz (2.412 to 2.485 GHz) 5 GHz
Communication Channel	The number of channels you can set varies depending on the region where you use the printer.
SSID	Any alphanumeric character (maximum 32)
Authentication	Open System Shared Key WPA/WPA2 Perform the RADIUS server authentication using 802.1x (EAP-TLS, LEAP, EAP-TTLS, EAP-PEAP, EAP-FAST protocol)
Encryption	None WEP (64 bits/128 bits) AES (WPA-PSK/WPA2-PSK, WPA-802.1x/WPA2-802.1x authentication)
Communication Mode	Infrastructure Ad Hoc

Software Specifications	
Supported Protocol	TCP/IP
Network Layer	IP, ICMP
Session Layer	TCP
Application Layer	LPD, FTP, DHCP, HTTPS, SNMP, NTP



Extensive contact information for worldwide
SATO operations can be found on the Internet at
www.satoworldwide.com

SATO